

3. 175
2. 19
15. 4±0. 35

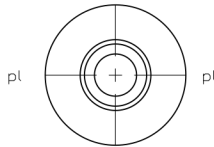
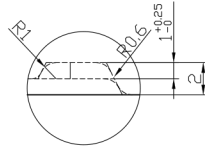
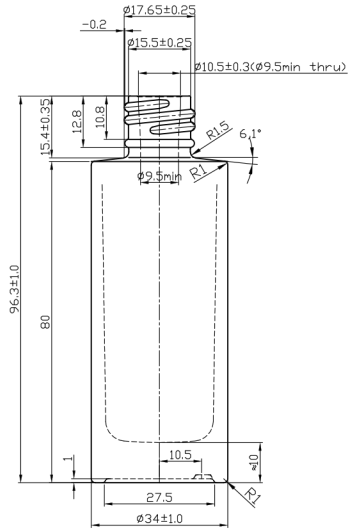

37 ± 2 ml
95 ± 5 g

PRODUCT CODE: KIT030LQFFGD

DIMENSIONS: 34MM (w) X 124.7MM (h)

DOC TYPE: TECHNICAL DRAWING

MATERIAL: GLASS

CAPACITY: 30ML

COLOR: FROSTED

DATE: 2/22/19

These drawings and specifications are the property of Instockpack and shall not be copied, reproduced, or used in any manner without the prior consent of Instockpack.

instockpack.

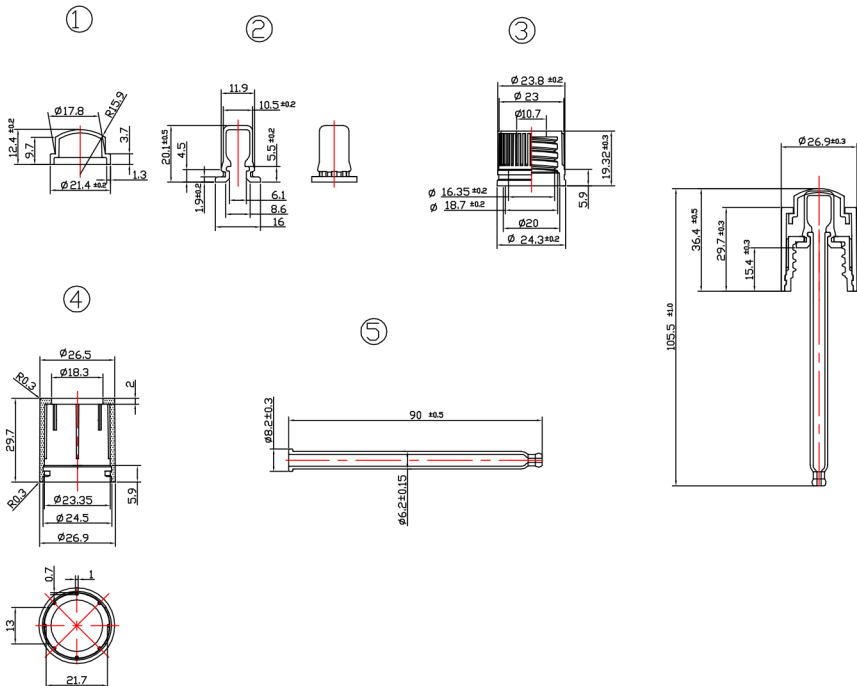

NO	Part Name	Material	Order #
1	Button	ABS	LG HF380-09705
2	Rubber Teat	SILICON/NBR	8493-6640-40 M&S
3	Inner Hole Cap	PP	JIS0
4	Outer Hole Cap	ABS	LG HF380-09705
4	Pipette	glass	

PRODUCT CODE: DROPPER 30ml

SCALE: 1:1

PRODUCT: DROPPER

DATE: 2/22/19

DOC TYPE: TECHNICAL DRAWING

REVISION: R1

These drawings and specifications are the property of Instockpack and shall not be copied, reproduced, or used in any manner without the prior consent of Instockpack.

instockpack.

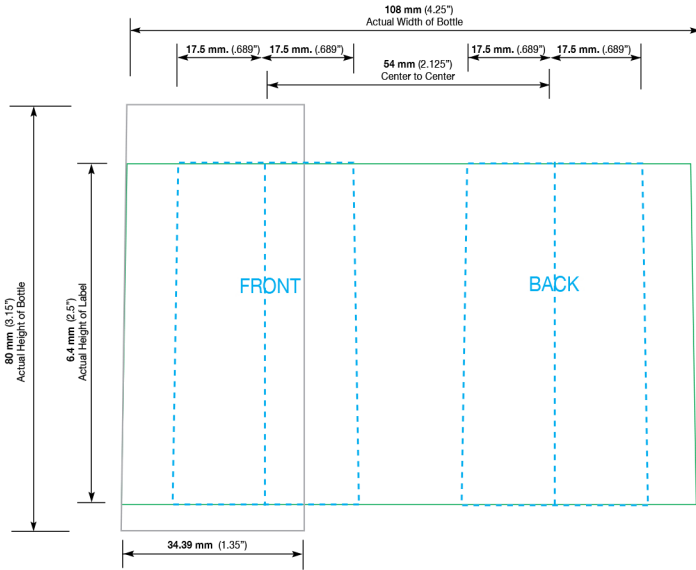

PRODUCT CODE: KIT030LQFFGD

30ml Liquid Foundation Frosted Glass Dropper Bottle

DIE LINE TYPE: S11k Screen

DATE: 06-JUN-2019

GENERAL INSTRUCTIONS:

Please include a PDF, list of colors, and convert text to outlines when submitting.

These drawings and specifications are the property of Instockpack and shall not be copied, reproduced, or used in any manner without the prior consent of Instockpack.

instockpack.

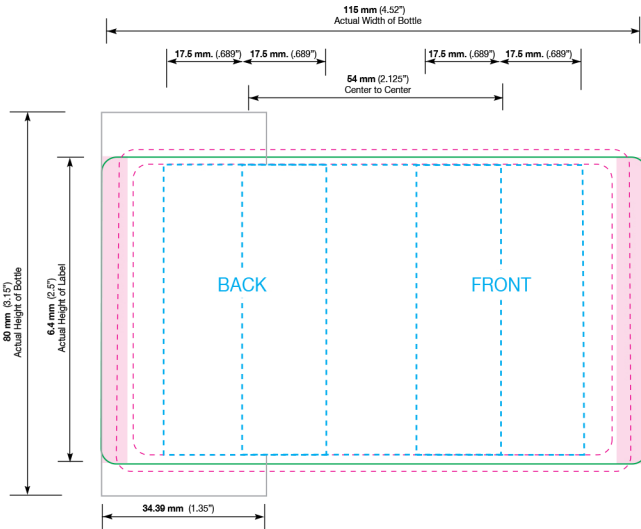

PRODUCT CODE: KIT030LQFFGD

30ml Liquid Foundation Frosted Glass Dropper Bottle

DIE LINE TYPE: Label (with overlap)

DATE: 06-JUN-2019

GENERAL INSTRUCTIONS:

Please include a PDF, list of colors, and convert text to outlines when submitting.



These drawings and specifications are the property of Instockpack and shall not be copied, reproduced, or used in any manner without the prior consent of Instockpack.

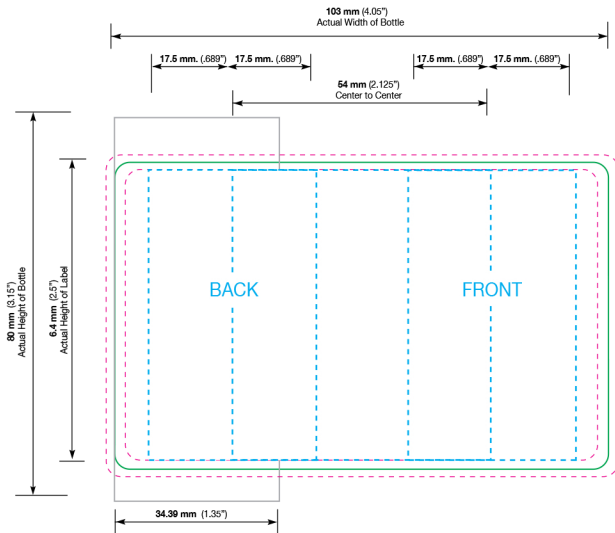

PRODUCT CODE: KIT030LQFFGD

30ml Liquid Foundation Frosted Glass Dropper Bottle

DIE LINE TYPE: Label (with gap)

DATE: 06-JUN-2019

GENERAL INSTRUCTIONS:

Please include a PDF, list of colors, and convert text to outlines when submitting.

These drawings and specifications are the property of Instockpack and shall not be copied, reproduced, or used in any manner without the prior consent of Instockpack.

