

SCALE 1/2

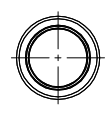
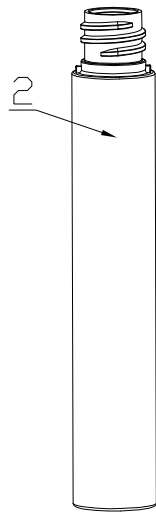
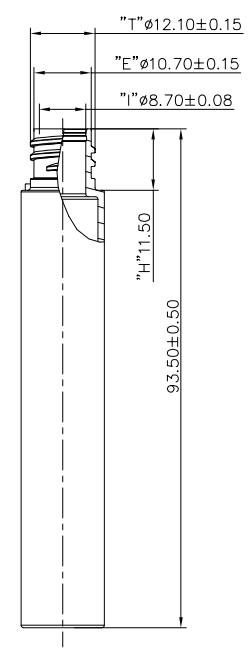
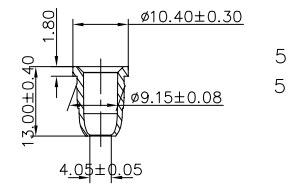
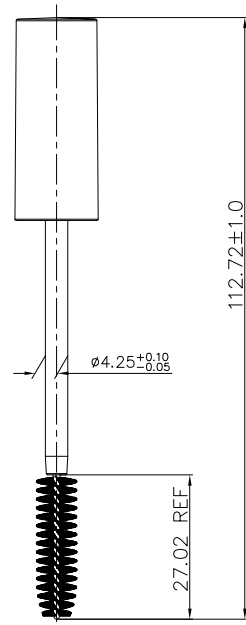
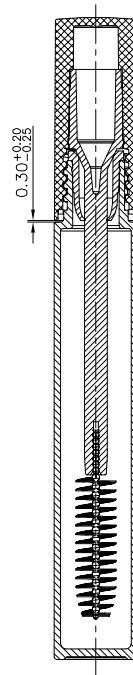
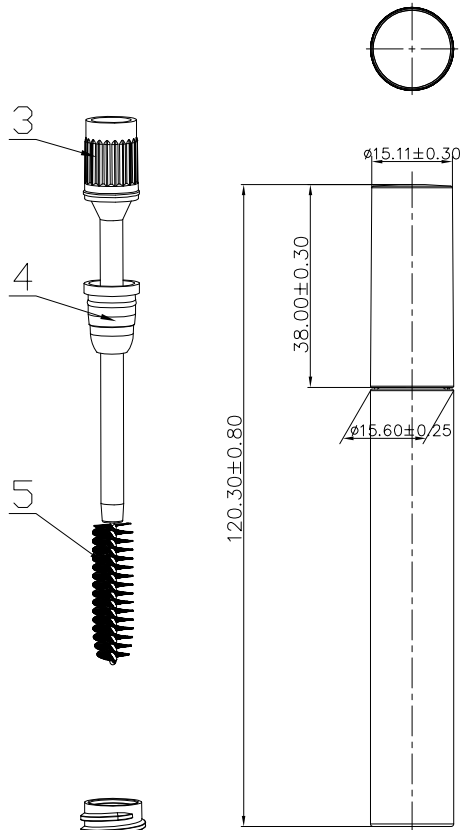

GEL.TOL: ±0.30
g.T: 12.24±1.0g

Part	Parts Name	Material	Weight
5	BRUSH		
4	WIPER	LDPE+EVA	0.34g
3	STEM	PP	1.26g
2	BOTTLE	PETG	6.64g
1	CAP	ABS	4.0g

PRODUCT CODE: EHST009MUMSC

SCALE: 1:1

PRODUCT: MASCARA

DATE: 9/17/19

DOC TYPE: TECHNICAL DRAWING

REVISION: R2

These drawings and specifications are the property of Instockpack and shall not be copied, reproduced, or used in any manner without the prior consent of Instockpack.

