

the EIKON SHELL

designed by Julia Jessen & Niklas Jessen | 2014



Eikon Shell „Olive“ with oak wood

Eikon Shell is a minimalist lamp made of certified wood and a coloured metal lampshade. The wooden base and the coloured shade are a perfect match for many home and interior design applications.

The light has a clean line that gives it a pure and contemporary look with a subtle reminder of the industrial age. The large Shell lampshade creates a very high light output. The magnetic connecting system allows the lampshade to be easily changed for another color or shape of the Eikon collection.

the EIKON SHELL

DIMENSIONS

54 cm x 32 cm

WEIGHT

4,24 kg

32 cm

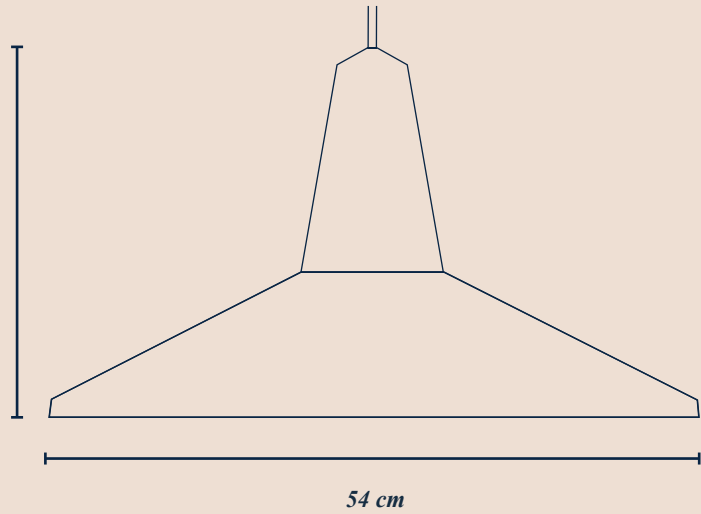

PRODUCTION PROCESSE

Eikon is made of certified wood and produced in Germany.

TYPE | ENVIRONMENT

Pendant lamp | indoor | UL listed

MATERIAL SOCKET



Ash



Oak

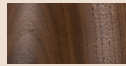

Walnut



German Design Award

SPECIAL MENTION 2015

LAMPESHADRE MATERIAL

Powder coated steel

Colors:

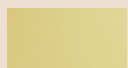

Olive

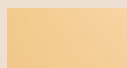

Peach

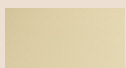

Wax



Wheat



Sky Blue



White

the EIKON SHELL is available in two other shapes (BASIC | CIRCUS).

the EIKON SHELL

CORD

Textile cord | length: 2.5 m

Cream

LIGHT SOURCE & ENERGY EFFICIENCY

E27 | Bulb is not included

Compatible with bulbs of the energy classes: A++ - E

Suggested lightbulb:



LED - 11 W



H - 40 W



I - 60 W

SPECIFICATIONS



IP20



VOLTAGE

220V - 240V | 50Hz

Other cords (voltage) on request.

CANOPY

Cable Cup covering included | white or black | 15,8 cm x 6 cm

Made out of soft material (PVC). The cup can be easily folded over and fits tight to the ceiling.

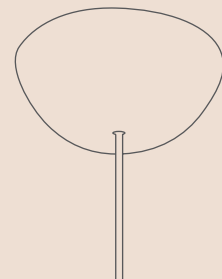
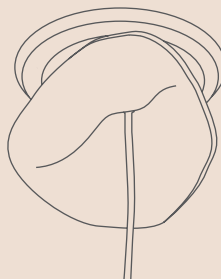
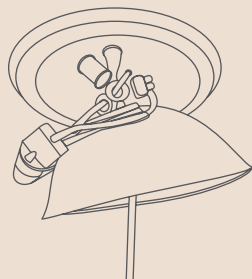

MAINTENANCE

Wipe off dust with feather duster. To remove fresh stains wipe with a slightly moist cloth. Always switch off the electricity before cleaning.