

EIERMANN 3 Table

M RICHARD LAMPERT
D Alexander Seifried, 2015

One of the classics in design history, got one more upgrade. In 2015, Alexander Seifried, allowed the table to go even bigger, with a new base. Thanks to the many colour options for the frame, the many different material options for the tabletop, the different sizes available and a design with either centrally positioned or offset crossbars, the table is the ideal solution for worktops, desks and conference tables.



Side frame depth: 22.8" / 30.7"

Stretcher length: 11.4" / 15.4" / 30.7"

Top:

- L 39.4" x W 23.6"
- L 47.2" x W 31.5"
- L 55.1" x W 31.5"
- L 63" x W 31.5" / 35.4"
- L 70.8" x W 35.4"
- L 78.7" x W 35.4" .

TABLE TOP MATERIALS

LINOLEUM colors

NERO BLACK
 PEBBLE
 ASH GREY
 CONIFER GREEN
 CHARCOAL
 SMOKEY BLUE
 BURGUNDY

REALLY KVADRAT TEXTILE colors

COTTON CREAM
 COTTON GREY
 COTTON CHARCOAL

SOLID WOOD colors

OAK NATURAL
 SMOKEY OAK WHITE
 OAK CHARCOAL GREY
 OAK CHARCOAL BLACK

FRAME COLORS

BLACK
 WHITE
 SILVER
 CHROME PLATED
 BRIGHT ORANGE
 OLIVE GREEN
 COLORLESS

edge: oak/ matching
 color



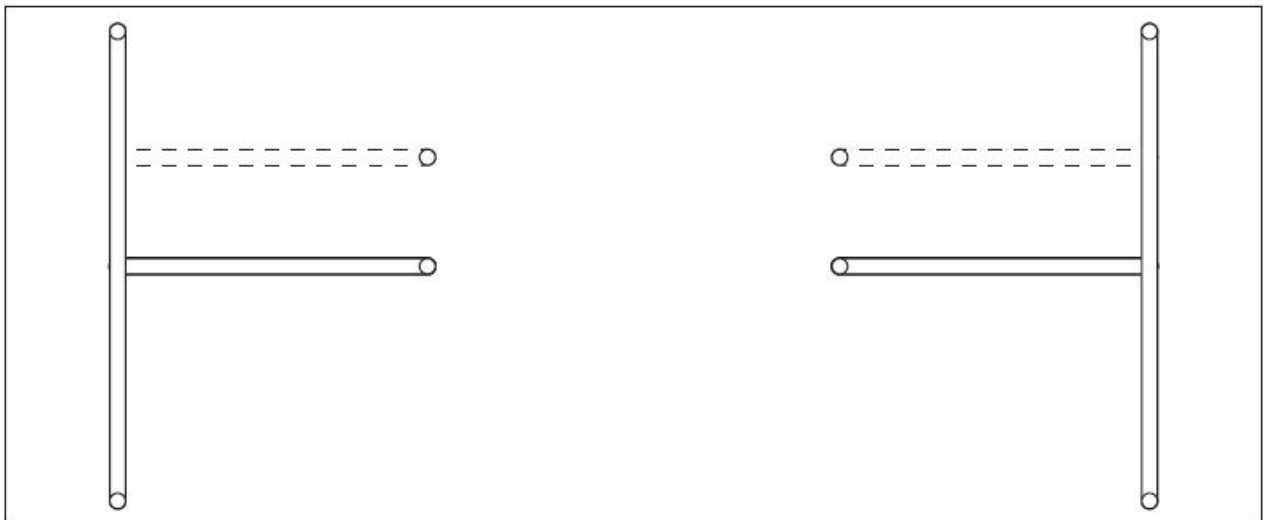
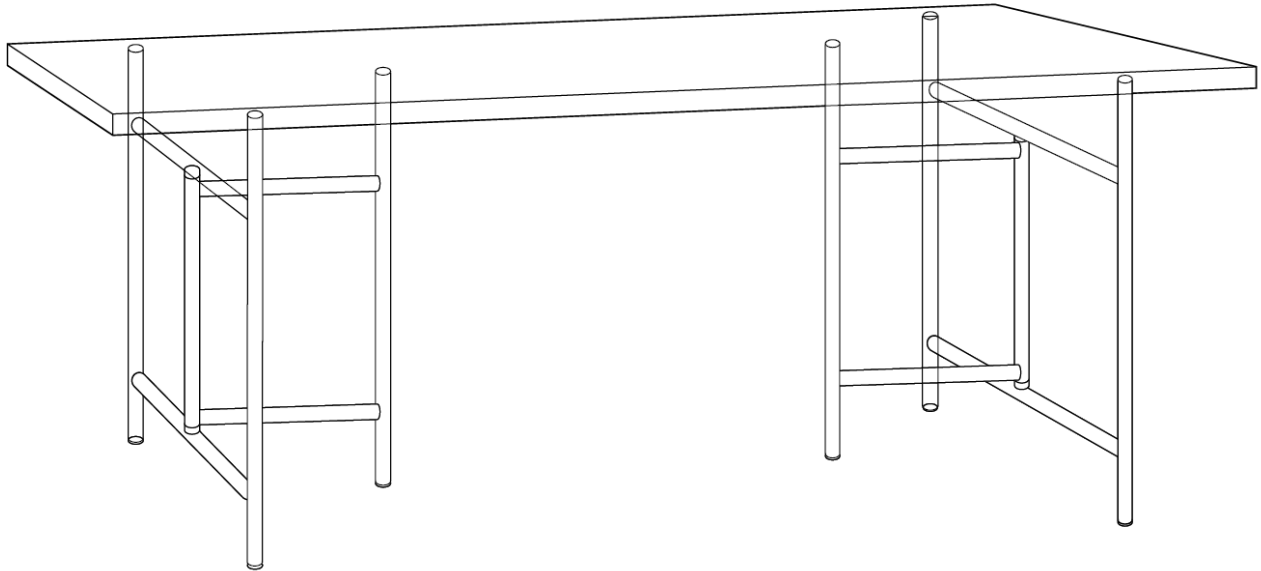

can be positioned centrally or off-center

FRAME COLORS

BLACK



CHROME PLATED



STAINLESS STEEL



WHITE



HOT TIP GALVANIZED



TABLE TOP COLORS

MELAMINE
oak/ color edge
1.1"

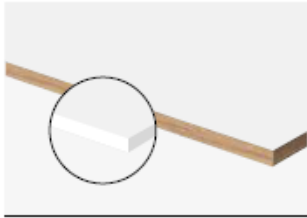

WHITE

SOLID WOOD
1"



SOLID OAK

LINOLEUM
oak/ matching
color edge
1.2"

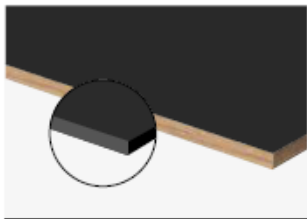

NERO 4023

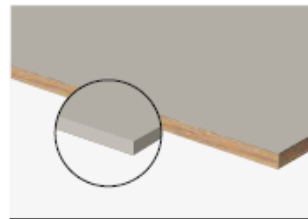

PEBBLE 4175

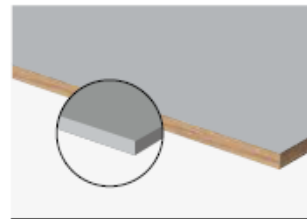

ASH 4132

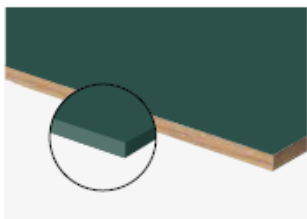

CONIFER 4174

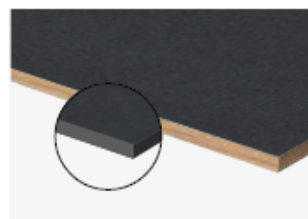

CHARCOAL 4166

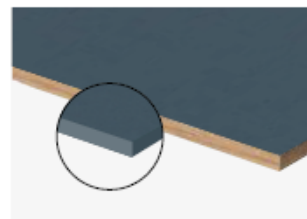

SMOKEY BLUE 4179

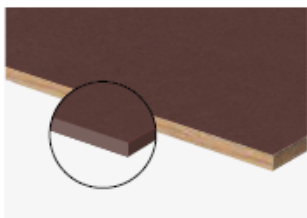

BURGUNDY 4154

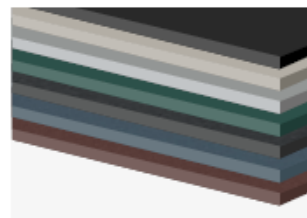

SOLID OAK

REALLY KVADRAT

textile tabletop
matching color edge
0.7"
table top support
recommended

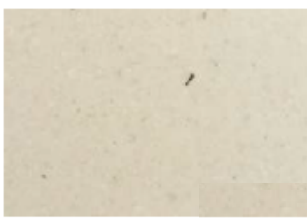

COTTON CREAM

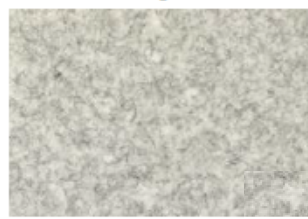

COTTON GREY



COTTON CHARCOAL

SOLID WOOD

Edition Janua
Stefan Kopp
1.3"/ 1.4"



SMOKEY OAK WHITE



OAK CHARCOAL GREY

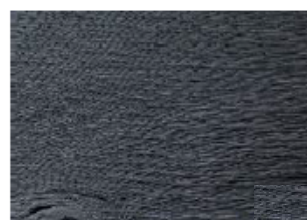

OAK CHARCOAL BLACK