

**WAGNER ARMLEHNSTUHL
WAGNER ARMREST CHAIR**

OUT
OBJEKTE UNSERER TAGE



STILLFRIED
WIEN

Some places radiate a feeling of familiarity and intimacy. A cozy warmth in which we let ourselves fall and feel at home. The WAGNER Armrest Chair invites you to experience this feeling anywhere. The generous backrest is also a supporting armrest and cultivates the feeling of security. Lightness and serenity are evident in the filigree frame made of powder-coated steel, which harmonizes the design and makes it stackable. The uncompromising geometry from WAGNER documents local craftsmanship and redefines seating comfort in its class.

Design

OUT, 2020

Material

Backrest: plywood with real oak wood veneer, lacquered
Base: powder-coated steel

Production process

Frame CNC bent, welded, and ground by hand.
Assembled by hand and upholstered by hand depending on the chosen option. Made in Germany.

Product Options

Backrest



Matt lacquered oak

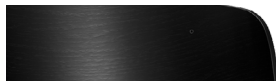

Lacquered oak black

Seat



Without upholstery



With upholstery

Glides



Plastic glides



Felt glides

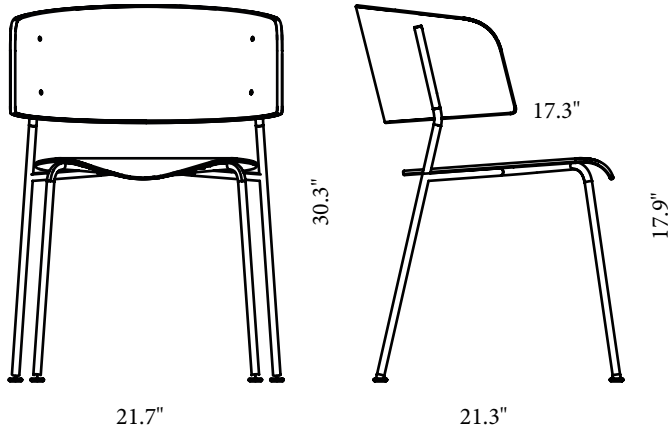

Stackable (up to 8 chairs)

With upholstery

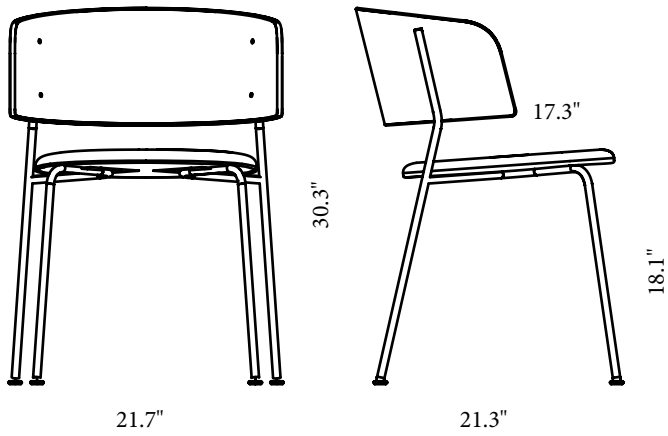

Stackable (up to 6 chairs)

Recommended Options

- Beige - Main Line Flax MLF 20
- Anthracite - Main Line Flax MLF 28
- Bouclé moon white - Promise 091
- Bouclé lava grey - Promise 095
- Pink - Vidar 4 622 by Kvadrat/Raf Simons
- Olive green - Vidar 4 956 by Kvadrat/Raf Simons
- Leather Dunes cognac
- Leather Dunes anthracite







	UPHOLSTERY PROGRAM		
	www.stillfried.com / office@stillfried.com / T +1 212 226 2921 / 40 WALKER STREET, NYC 10013		

FABRIC CATEGORY 1

FABRIC CATEGORY 1

ERA

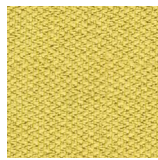
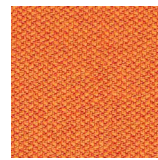
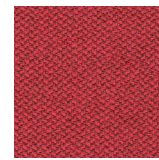
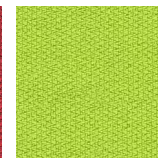
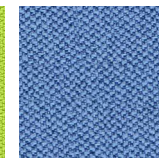
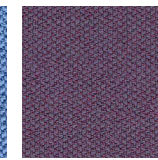
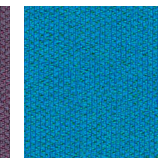
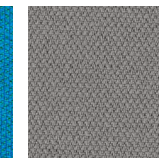
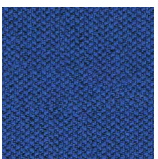
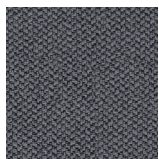
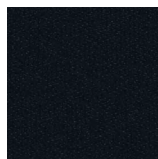
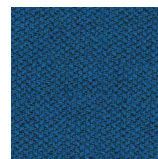
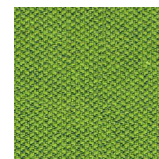
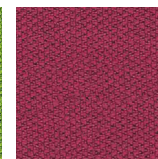
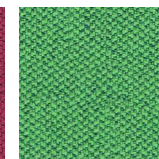
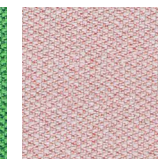
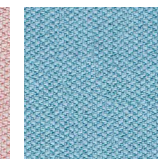
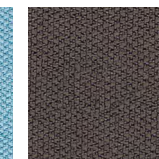
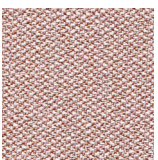
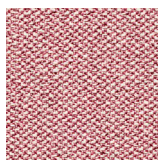
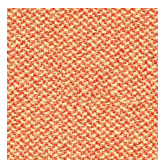
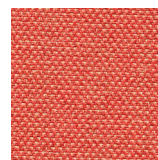
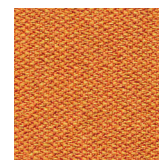
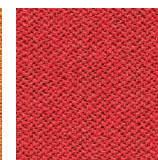
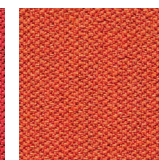
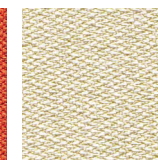
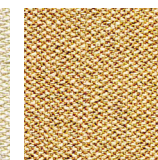
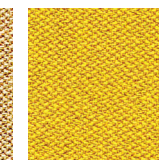
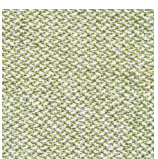
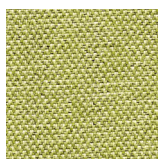
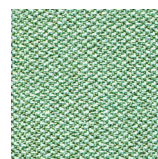
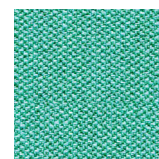
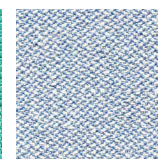
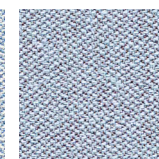
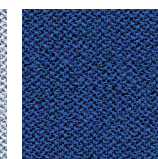
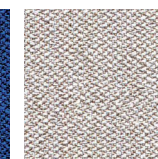
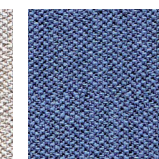
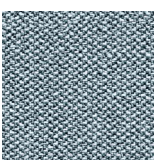
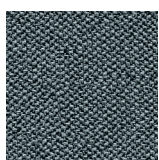
Manufacturer Camira
Composition 100% polyester
Durability 100.000 martindale
Lightfastness 5 (ISO 105 - B02)
Flammability _ EN 1021 - 1&2 Cigarette & Match _ BS 7176 Low Hazard _ EN 13501-1 Adhered Class B, s1, d0 _ EN 13501-1 Un-adhered Class C, s1, d0
Environmental _ Certified to OEKO-TEX® Standard 100 _ Certified to Indoor Advantage™ „Gold“ _ Non metallic dyestuffs

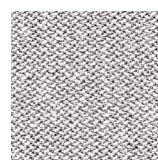
									
CSE01	CSE02	CSE03	CSE05	CSE06	CSE07	CSE08	CSE09	CSE10	CSE11
									
CSE12	CSE13	CSE14	CSE15	CSE16	CSE17	CSE18	CSE19	CSE20	CSE21
									
CSE23	CSE24	CSE25	CSE26	CSE27	CSE28	CSE29	CSE30	CSE31	CSE32
									
CSE33	CSE34	CSE35	CSE36	CSE37	CSE38	CSE39	CSE40	CSE41	CSE42
									
CSE43	CSE44	CSE45	CSE46						

FABRIC CATEGORY 1

RELATE

Manufacturer Kvadrat
Composition 100% Trevira CS
Durability 80.000 martindale
Lightfastness 6-7
Flammability <ul style="list-style-type: none">_ BS 5852 Crib 5_ IMO FTP Code 2010 Part 8_ NF D 60 013_ NFPA 701_ SN 198 898 5.2_ UNI 9177 Classe 1_ US Cal. Bull. 117-2013_ NF P 92 507 M1_ DIN 4102 B1_ EN 1021-1/2_ ÖNORM B1/Q1_ ASTM E84 Class A Unadhered_ ASTM E84 Class B Adhered_ UNI 9175 11M_ AS/NZS 3837 class 2_ EN 13501-1, B-s1, d0_ BS 5867 part 2 type B_ BS 5852 part 1 with treatment
Environmental <ul style="list-style-type: none">_ EU Ecolabel

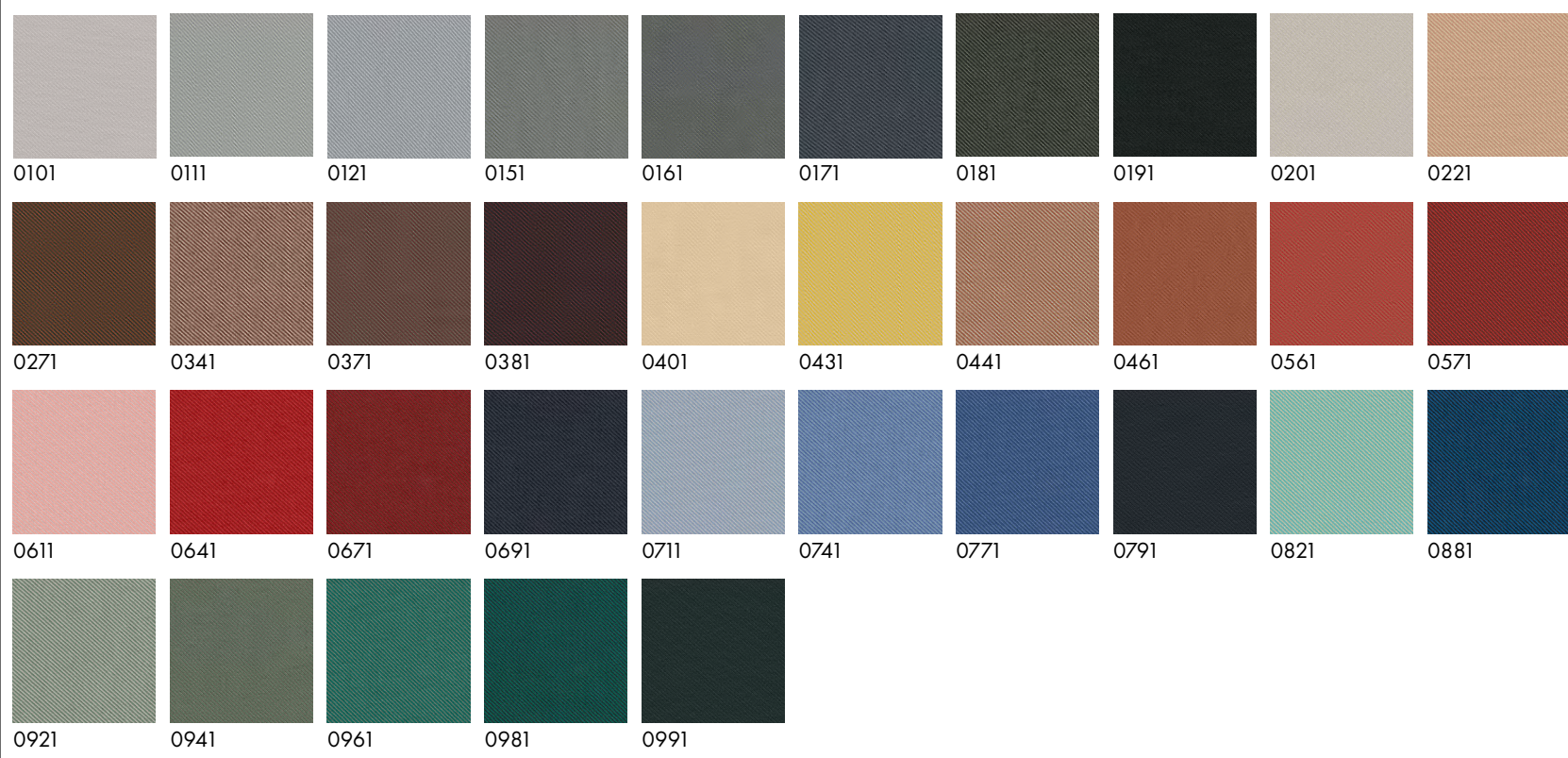

FABRIC CATEGORY 1

XTREME

Manufacturer
Camira

Composition
100% post-consumer recycled polyester

Durability
100.000 martindale

Lightfastness
6 (ISO 105 - B02)

Flammability
 _ EN 1021 - 1&2 Cigarette & Match
 _ BS 7176 Low Hazard
 _ BS 5852 Ignition Source 5
 _ BS 7176 Medium Hazard
 _ DIN 4102 B1
 _ NF D 60-013
 _ ÖNORM B 3825 & A 3800-1 (over 58 kg/m3 CMHR foam)
 _ UNI 9175 Classe 1 IM
 _ BS 476 Part 7 Class 1

Environmental
 _ Certified to the EU Ecolabel
 _ Certified to OEKO-TEX® Standard 100
 _ Certified to Indoor Advantage™ „Gold“
 _ Made from 100% recycled polyester
 _ Non metallic dyestuffs











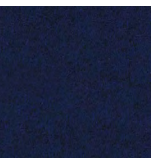



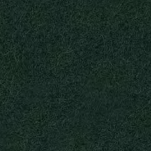

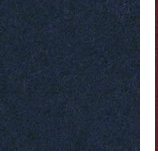
FABRIC CATEGORY 2

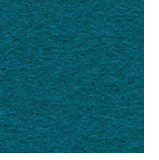
FABRIC CATEGORY 2

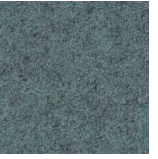
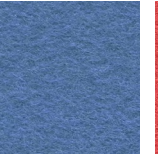
BLAZER

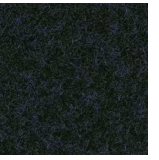







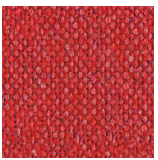

Manufacturer Carmira
Composition 100% virgin wool. Non metallic dyestuffs
Durability 50.000 martindale
Lightfastness 5 (ISO 105 - B02)
Flammability _ EN 1021 - 1&2 Cigarette & Match _ BS 7176 Low Hazard _ NF D 60-013 _ ÖNORM B 3825 & A 3800-1 (58kg/m3 CMHR Foam) _ UNI 9175 Classe 1 IM _ BS 476 Part 7 Class 1 (Adhered) _ EN 13501-1 Adhered Class D, s1, d0 _ BS 5852 Ignition Source 5 when FR treated _ BS 7176 Medium Hazard when FR treated _ BS 476 Part 6 Class 0 when FR treated (Adhered) _ EN 13501-1 Adhered Class B, s1, d0 when FR treated _ EN 13501-1 Un-adhered Class D, s2, d0 when FR treated _ BS 5867-2 Type B Curtains & Drapes when FR treated
Environmental _ Certified to Indoor Advantage™ „Gold“ _ Rapidly renewable and compostable

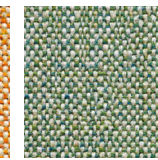
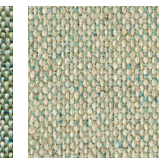
									
CUZ02	CUZ08	CUZ09	CUZ12	CUZ13	CUZ18	CUZ1E	CUZ1F	CUZ1J	CUZ1K
									
CUZ1L	CUZ1M	CUZ1N	CUZ1P	CUZ1R	CUZ1T	CUZ1V	CUZ1W	CUZ1Y	CUZ21
									
CUZ26	CUZ28	CUZ2Q	CUZ2R	CUZ2S	CUZ2T	CUZ2U	CUZ2W	CUZ2X	CUZ2Y
									
CUZ2Z	CUZ30	CUZ31	CUZ33	CUZ35	CUZ39	CUZ3A	CUZ3B	CUZ3C	CUZ3D
									
CUZ3E	CUZ47	CUZ53	CUZ58	CUZ62	CUZ63	CUZ67	CUZ82	CUZ86	CUZ90

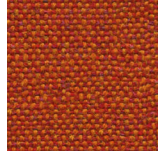
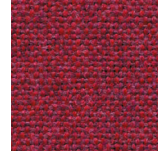
FABRIC CATEGORY 2

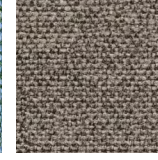
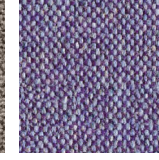
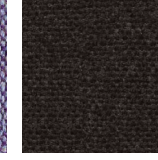
MAIN LINE FLAX

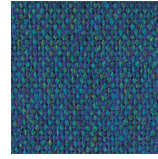
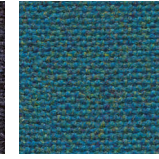
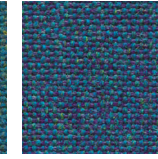
Manufacturer Camira
Composition 70% virgin wool, 30% flax
Durability 50.000 martindale
Lightfastness 5 (ISO 105 - B02)
Flammability <ul style="list-style-type: none"> _ EN 1021-1&2 Cigarette & Match _ BS 7176 Low Hazard _ BS 5852 Ignition Source 5 _ BS 7176 Medium Hazard _ NF D 60-013 _ ÖNORM B 3825 & A 3800-1 (58kg/m3 CMHR Foam) _ UNI 9175 Classe 1 IM _ BS 5867-2: Type B Curtains & Drapes
Environmental <ul style="list-style-type: none"> _ Certified to the EU Ecolabel _ Certified to Indoor Advantage™ „Gold“ _ Rapidly renewable and compostable _ Made from wool and bast fibre

									
MLF01	MLF02	MLF03	MLF04	MLF05	MLF06	MLF07	MLF08	MLF09	MLF10
									
MLF11	MLF12	MLF13	MLF14	MLF15	MLF16	MLF17	MLF18	MLF19	MLF20
									
MLF21	MLF22	MLF23	MLF24	MLF25	MLF26	MLF27	MLF28	MLF29	MLF30
									
MLF31	MLF32	MLF33	MLF34	MLF35	MLF36	MLF37	MLF38	MLF39	MLF40
									
MLF41									

FABRIC CATEGORY 2

REMIX 3

Manufacturer Kvadrat
Composition 90% new wool worsted, 10% nylon
Durability 100.000 martindale
Lightfastness 6
Flammability <ul style="list-style-type: none"> _ AS/NZS 1530.3 _ BS 5852 crib 5 with treatment _ BS 5852 part 1 _ IMO FTP Code 2010 Part 7 with treatment _ IMO FTP Code 2010 Part 8 _ NF D 60 013 _ NFPA 260 _ SN 198 898 5.3 with treatment _ UNI 9175 11M _ US Cal. Bull. 117-2013 _ EN 1021-1/2 _ AS/NZS 3837 class 2 _ ÖNORM B1/Q1 _ ASTM E84 Class A Unadhered _ ASTM E84 Class A Adhered _ GB 50222 B1 with treatment (Chinese)
Environmental <ul style="list-style-type: none"> _ EU Ecolabel _ Greenguard Gold _ HPD _ EPD

									
0113	0123	0126	0133	0136	0143	0152	0163	0171	0183
									
0196	0223	0233	0242	0252	0266	0276	0286	0296	0326
									
0346	0356	0362	0373	0383	0393	0406	0412	0422	0433
									
0443	0452	0516	0536	0543	0566	0606	0612	0632	0643
									
0653	0662	0672	0682	0686	0692	0716	0722	0733	0743
									
0753	0762	0773	0783	0796	0816	0826	0836	0842	0852



0866



0873



0906

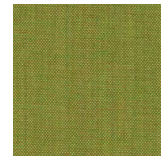

0912



0923

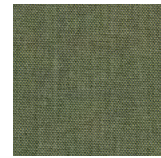

0933

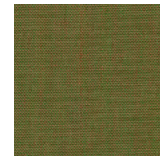

0942



0954



0962



0973

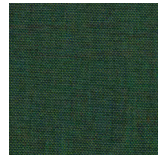

0982



0996

FABRIC CATEGORY 3

FABRIC CATEGORY 3

CITY VELVET RELOADED

Manufacturer
JAB

Composition
Pile: 100% polyester, groundmaterial: 100% polyester

Durability
100.000 martindale

More than 150 colors available



FABRIC CATEGORY 3

PROMISE

Manufacturer
JAB (Chivasso)

Composition
100% polyester

Durability
100.000 martindale



010

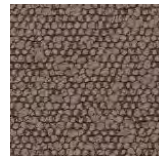

020

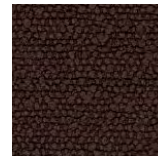

021

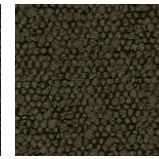

030

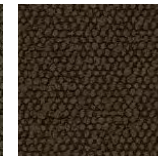

031

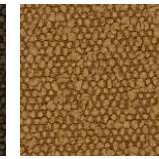

040

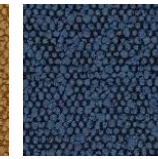

050

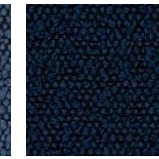

051

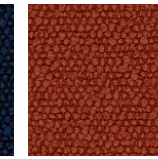

060

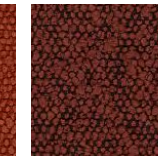

061



070

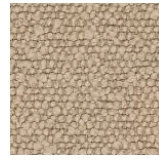

071

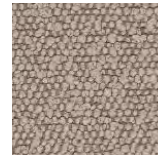

072



090

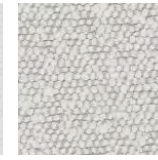

091

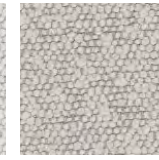

092

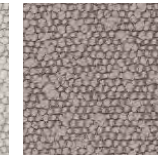

093

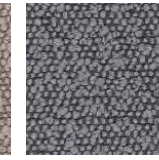

094

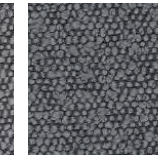

095

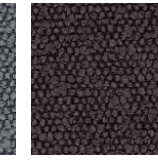

096



099

FABRIC CATEGORY 3

RE-WOOL

Manufacturer
Kvadrat

Composition
45% new wool (worsted), 45% recycled wool, 10% nylon

Durability
100.000 martindale

Lightfastness
7

Flammability
 _ AS/NZS 1530.3
 _ BS 5852 Crib 5 with treatment
 _ BS 5852 ignition source 3
 _ BS 5852 part 1
 _ EN 1021-1/2
 _ IMO FTP Code 2010 Part 8
 _ NF D 60 013
 _ UNI 9175 11M
 _ US Cal. Bull. 117-2013
 _ ÖNORM B1/ Q1
 _ AS/NZS 3837, class 2

Environmental
 _ Complies with EU Ecolabel
 _ Recycled content
 _ No use of AZO dyes, which may split of carcinogenic acryl amines
 _ No use of dyes containing heavy metals/complies with ETAD norm
 _ No use of brominated flame retardants
 _ Complies with REACH
 _ Greenguard and Greenguard Gold certified

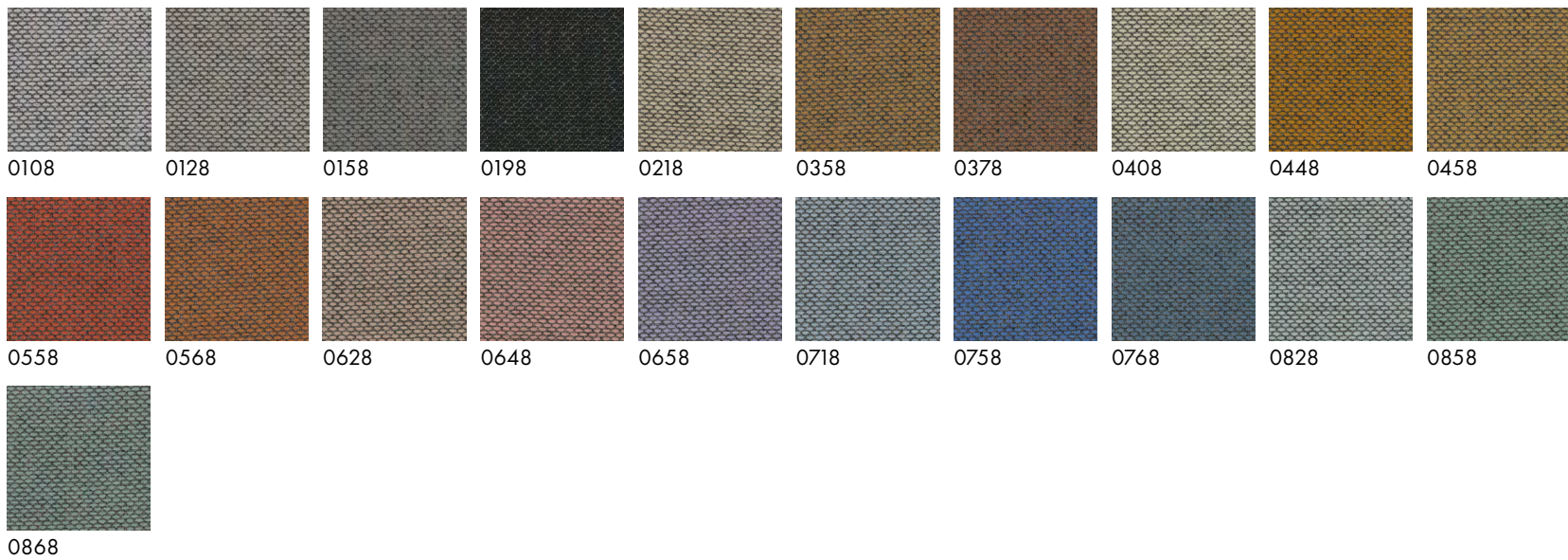

FABRIC CATEGORY 3

YOREDALE

Manufacturer Camira
Composition 95% wool, 3% polyester, 2% polyamide
Durability 50.000 martindale
Lightfastness 5 (ISO 105 - B02)
Flammability <ul style="list-style-type: none"> _ EN 1021 - 1&2 Cigarette & Match _ BS 7176 Low Hazard _ ÖNORM B 3825 & A 3800-1 (58kg/m3 CMHR Foam) _ UNI 9175 Classe 1 IM _ BS 5852 Ignition Source 5 when FR treated _ BS 7176 Medium Hazard when FR treated
Environmental <ul style="list-style-type: none"> _ Certified to Indoor Advantage™ „Gold“ _ Non metallic dyestuffs

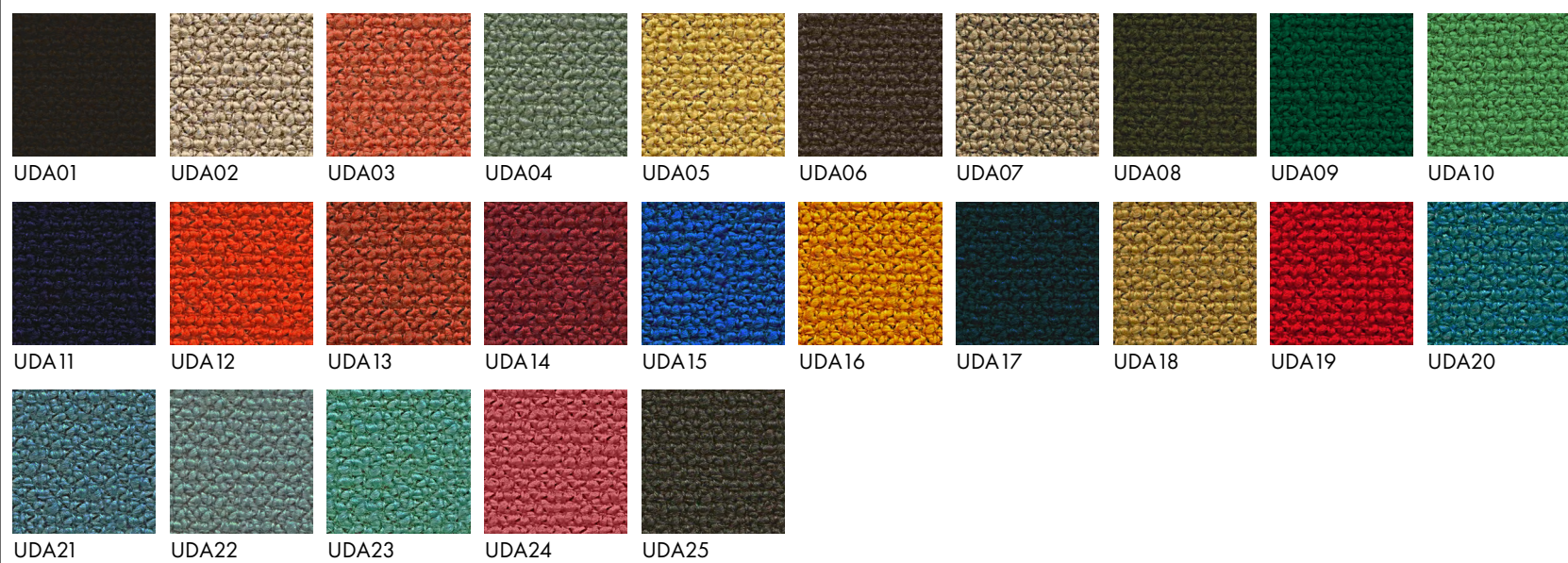

FABRIC CATEGORY 4

FABRIC CATEGORY 4

CLAY

Manufacturer Kvadrat (Sahco)
Composition 76% linen, 21% cotton, 3% polyester
Durability 45.000 martindale
Lightfastness 5
Flammability <ul style="list-style-type: none">_ BS 5852 crib 5 with treatment_ BS 5852 part 1_ EN 1021-1/2_ US Cal. 117-2013 with Cal. 117 compliant interliner
Environmental <ul style="list-style-type: none">_ Greenguard Gold_ HPD_ EPD



FABRIC CATEGORY 4

FIORD 2

Manufacturer Kvadrat
Composition 92% new wool worsted, 8% nylon
Durability 60.000 martindale
Lightfastness 6
Flammability <ul style="list-style-type: none"> _ BS 5852 crib 5 with treatment _ BS 5852 part 1 _ IMO FTP Code 2010 Part 8 _ NF D 60 013 _ NFPA 260 _ SN 198 898 5.3 with treatment _ UNI 9175 11M _ US Cal. Bull. 117-2013 _ EN 1021-1/2 _ ASTM E84 Class A Adhered _ ASTM E84 Class A Unadhered _ AS/NZS 3837 class 2 _ GB 50222 B1 with treatment (Chinese) _ ÖNORM B1/Q1
Environmental <ul style="list-style-type: none"> _ EU Ecolabel _ Greenguard Gold _ HPD _ EPD

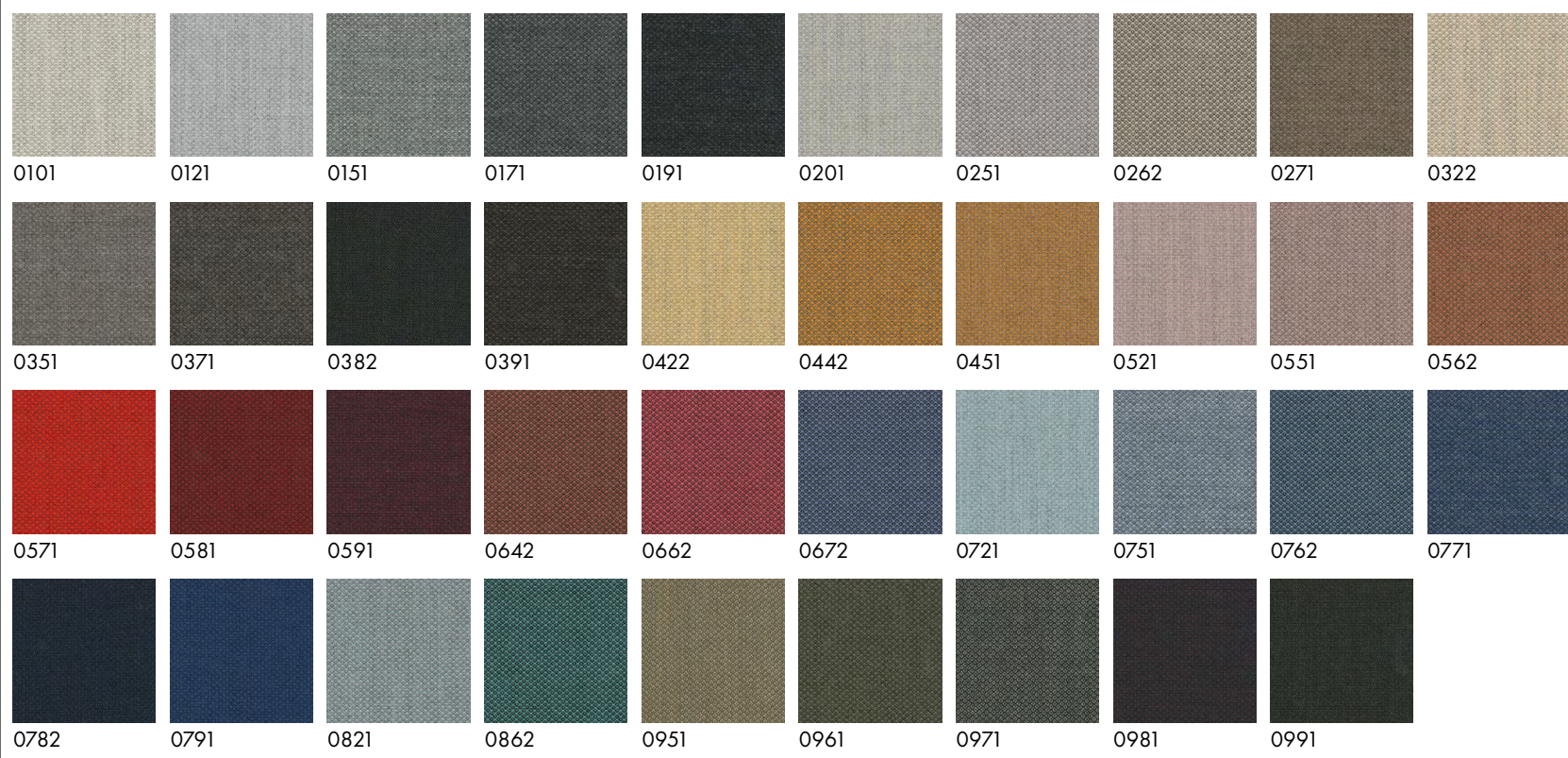

FABRIC CATEGORY 4

HALLINGDAL 65

Manufacturer
Kvadrat

Composition
70% new wool, 30% viscose

Durability
100.000 martindale

Lightfastness
7

Flammability
 _ AS/NZS 1530.3
 _ BS 5852 Crib 5
 _ BS 5852 part 1
 _ IMO FTP Code 2010 Part 8
 _ NF D 60 013
 _ NFPA 260
 _ UNI 9175 11M
 _ US Cal. Bull. 117-2013
 _ EN 1021-1/2
 _ ASTM E84 Class A Adhered
 _ SN 198 898 5.3 with treatment
 _ ÖNORM B1/Q1
 _ GB 50222 B1 with treatment (Chinese)
 _ AS/NZS 3837 class 2
 _ ASTM E84 Class B Unadhered

Environmental
 _ EU Ecolabel
 _ Greenguard Gold
 _ HPD
 _ EPD



FABRIC CATEGORY 4

HARALD 3

Manufacturer Kvadrat
Composition 100% cotton
Durability 100.000 martindale
Lightfastness 5
Flammability _ EN 1021-1 _ AS/NZS 1530.3 _ AS/NZS 3837, class 1
Environmental _ No use of AZO dyes, which may split off carcinogenic acrylamines _ No use of dyes containing heavy metals/complies with ETAD norm _ No use of brominated flame retardants _ Content of formaldehyde below 75 ppm, according the to EU Eco label requirements _ Adheres to the limits set by the Danish Environmental Protection Agency's 'List of undesirable substances' _ Complies with REACH regulation



FABRIC CATEGORY 4

STEELCUT 2

Manufacturer Kvadrat
Composition 90% new wool worsted, 10% nylon
Durability 100.000 martindale
Lightfastness 5
Flammability _ AS/NZS 1530.3 _ BS 5852 crib 5 with treatment _ BS 5852 part 1 _ IMO FTP Code 2010 Part 8 _ NF D 60 013 _ NFPA 260 _ SN 198 898 5.3 with treatment _ UNI 9175 11M _ US Cal. Bull. 117-2013 _ EN 1021-1/2 _ AS/NZS 3837 class 2 _ ÖNORM B1/Q1 _ ASTM E84 Class A Unadhered _ ASTM E84 Class B Adhered
Environmental _ EU Ecolabel _ Greenguard Gold _ HPD _ EPD

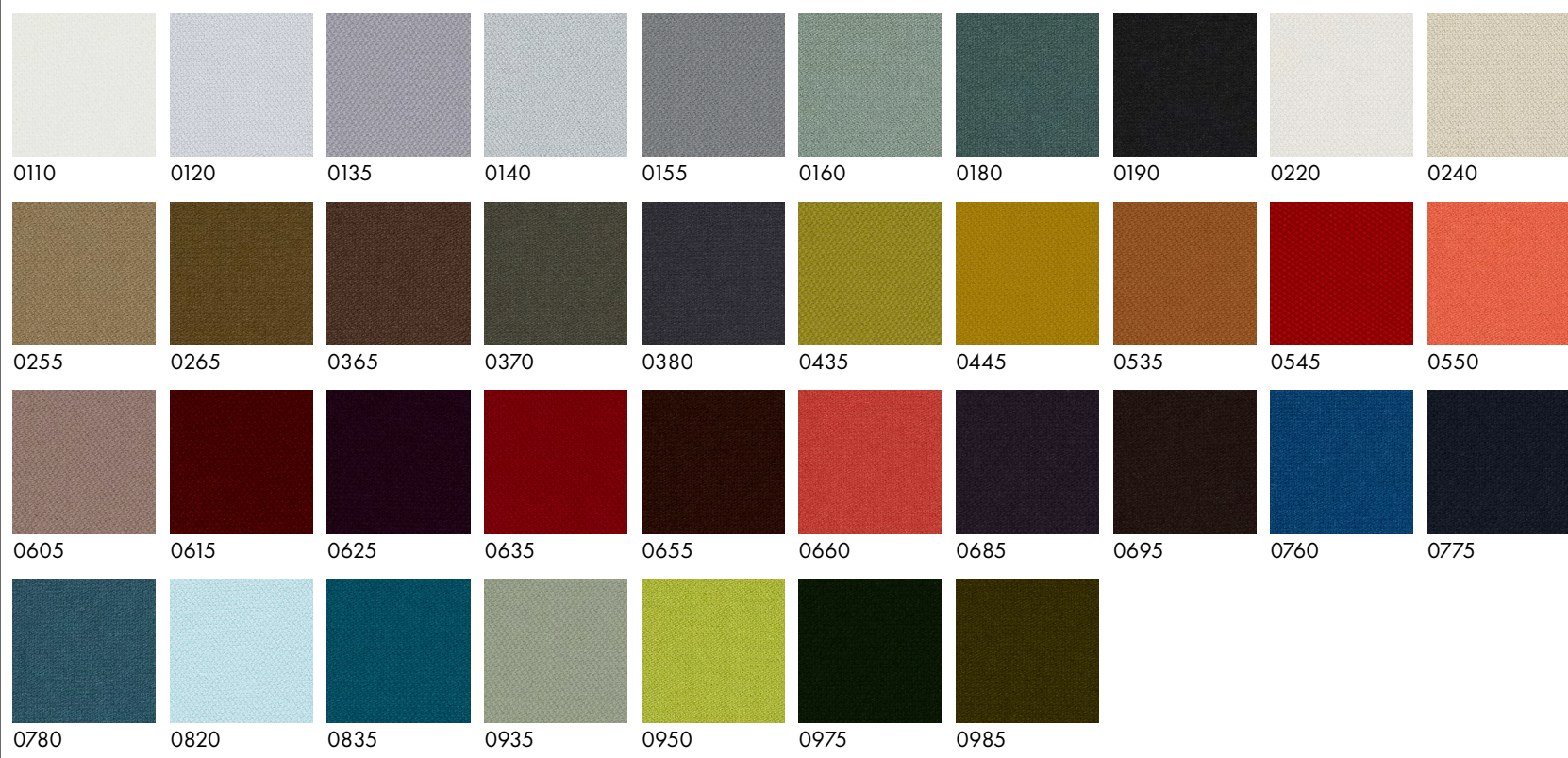

FABRIC CATEGORY 4

STEELCUT TRIO 3

Manufacturer Kvadrat
Composition 90% new wool worsted, 10% nylon
Durability 100.000 martindale
Lightfastness 6-7
Flammability _ AS/NZS 1530.3 _ BS 5852 crib 5 with treatment _ BS 5852 part 1 _ IMO FTP Code 2010 Part 8 _ NF D 60 013 _ NFPA 260 _ SN 198 898 5.3 with treatment _ UNI 9175 11M _ US Cal. Bull. 117-2013 _ EN 1021-1/2 _ ASTM E84 Class B Unadhered _ ASTM E84 Class B Adhered _ ÖNORM B1/Q1 _ AS/NZS 3837 class 2 _ GB 50222 B1 with treatment (Chinese)
Environmental _ EU Ecolabel _ Greenguard Gold _ HPD _ EPD



FABRIC CATEGORY 4

TWILL WEAVE

Manufacturer Kvadrat
Composition 90% new wool (worsted), 10% nylon
Durability 60.000 martindale
Lightfastness 6-7
Flammability <ul style="list-style-type: none">_ AS/NZS 1530.3_ BS 5852 ignition source 3_ BS 5852 part 1_ EN 1021-1/2_ IMO FTP Code 2010 Part 8_ US Cal. Bull. 117-2013_ NF D 60 013_ UNI 9175 11M_ BS 5852 Crib 5 with treatment_ SN 198 898 5.3 with treatment_ AS/NZS 3837, class 3_ DIN 4102 B1 with treatment_ ÖNORM B1/ Q1
Environmental <ul style="list-style-type: none">_ EU Ecolabel compliant_ REACH compliant_ Californian Proposition 65 list compliant_ LBC Red list compliant



FABRIC CATEGORY 5

FABRIC CATEGORY 5

BARU

Manufacturer Kvadrat (Sahco)
Composition 87% wool, 10% polyester, 3% polyamide
Durability 65.000 martindale
Lightfastness 4-5
Flammability _ BS 5852 part 1 _ US Cal. Bull. 117-2013 _ EN 1021-1/2 _ BS 5852 crib 5 with treatment
Environmental _ Greenguard Gold _ EPD



0120



0150

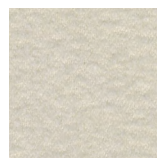

0200



0330

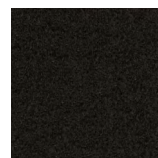

0390



0410



0450



0570



0740

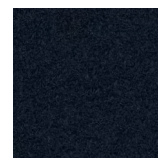

0780



0950

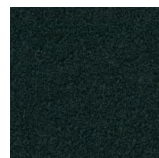

0980

FABRIC CATEGORY 5

CODA 2



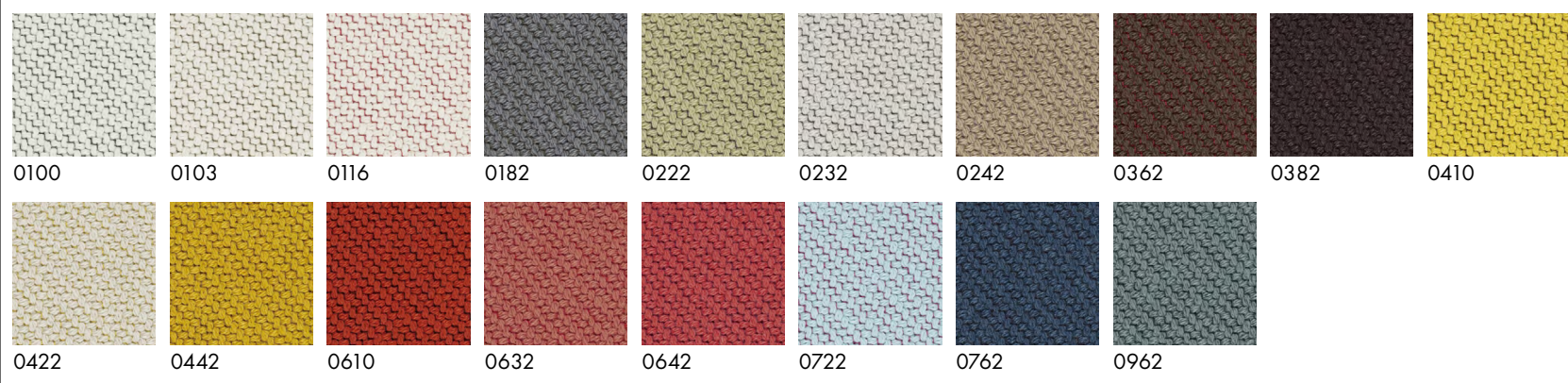

Manufacturer Kvadrat
Composition 90% new wool, 10% nylon
Durability 100.000 martindale
Lightfastness 6-7
Flammability <ul style="list-style-type: none"> _ BS 5852 part 1 _ EN 1021-1/2 _ IMO FTP Code 2010 Part 8 _ NF D 60 013 _ NFPA 260 _ SN 198 898 5.3 with treatment _ UNI 9175 11M _ US Cal. Bull. 117-2013 _ BS 5852 Crib 5 with treatment _ AS/NZS 3837, class 3 _ ÖNORM B1/ Q1
Environmental <ul style="list-style-type: none"> _ Follow the EU Ecolabel dye restrictions incl. AZO dye and heavy metal restrictions _ REACH compliant _ Californian Proposition 65 list compliant _ LBC Red list compliant

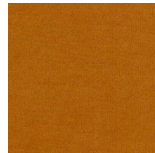

FABRIC CATEGORY 5

GENTLE 2

Manufacturer Kvadrat Febrik
Composition 60% new wool, 20% nylon, 20% polyester
Durability 90.000 martindale
Lightfastness 6-7
Flammability _ BS 5852 crib 5 with treatment _ BS 5852 part 1 _ IMO FTP Code 2010 Part 8 _ UNI 9175 11M _ US Cal. Bull. 117-2013 _ DIN 4102 B2 _ EN 1021-1/2 _ ASTM E84 Class A Unadhered
Environmental _ No use of AZO dyes, which may split off carcinogenic acryl amines _ No use of dyes containing more heavy metals than allowed _ No content of formaldehyde _ No use of brominated flame retardants _ Complies with REACH regulation

									
0113	0133	0183	0193	0203	0223	0373	0443	0553	0573
									
0623	0663	0673	0683	0733	0753	0783	0873	0933	0963
									
0973									

FABRIC CATEGORY 5

SPRINKLES

<p>Manufacturer Kvadrat</p>
<p>Composition 40% polyester filling, 30% new wool, 20% polyester, 10% nylon</p>
<p>Durability 80.000 martindale</p>
<p>Lightfastness 7</p>
<p>Flammability _ BS 5852 crib 5 with treatment _ BS 5852 part 1 _ UNI 9175 1IM _ US Cal. Bull. 117-2013 _ DIN 4102 B2 _ EN 1021-1/2 _ ASTM E84 Class A Unadhered _ IMO FTP Code 2010 Part 8 _ IMO FTP Code 2010 Part 9</p>
<p>Environmental _ Greenguard Gold _ HPD _ EPD</p>

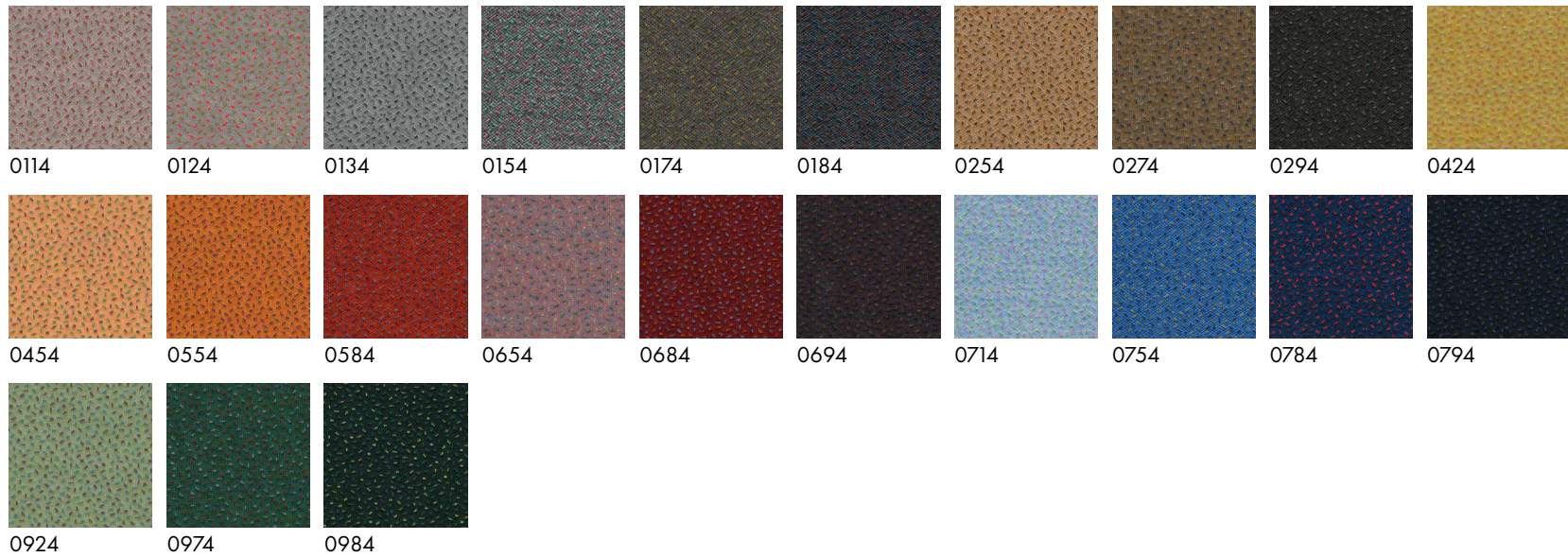

FABRIC CATEGORY 5

VIDAR 4

Manufacturer
Kvadrat

Composition
94% new wool, 6% nylon

Durability
100.000 martindale

Lightfastness
5-6

Flammability
 _ EN 1021-1/2
 _ IMO FTP Code 2010 Part 8
 _ NF D 60 013
 _ UNI 9175 11M
 _ US Cal. Bull. 117-2013
 _ BS 5852 part 1
 _ NFPA 260
 _ BS 5852 Crib 5 with treatment
 _ AS/NZS 3837, class 2
 _ GB 50222 B1 with treatment

Environmental
 _ No use of AZO dyes, which may split off carcinogenic acrylamines
 _ No use of dyes containing heavy metals
 _ No content of formaldehyde
 _ Adheres to the limits set by the the Danish Environmental Protection Agency's 'List of undesirable substances'
 _ No use of brominated flameretardants
 _ Complies with REACH regulation
 _ Non metallic dyestuffs



LEATHER CATEGORY 1

LEATHER CATEGORY 1

ULTRA

Manufacturer Sørensen Leather
Material Protected leather
Thickness 0.9-1.1 mm

									
Navy	Brandy	Lava	Altweiß	Sun	Poppy	Brick	Anthracite	Eggshell	Sand
									
Marble	Earth	Grey	Safari	Oragne	Brown	Chocolate	Black Brown	Apple	Purple
									
White	Coffee	Cognac	Black						

LEATHER CATEGORY 2

LEATHER CATEGORY 2

DUNES

Manufacturer
Sørensen Leather

Material
Aniline leather

Thickness
1.1-1.3 mm

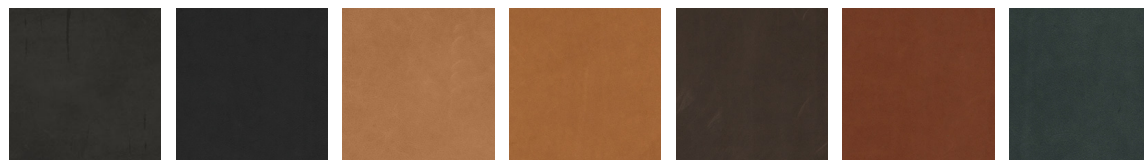

Grey

Anthracite

Camel

Cognac

Dark Brown

Rust

Green

	DESIGNED IN BERLIN MADE IN GERMANY		