

OLA SOFA



OBJEKTE
UNSERER
TAGE



STILLFRIED
WIEN

www.stillfried.com / office@stillfried.com / T +1 212 226 2921 / 40 WALKER STREET, 10013 NEW YORK

The OLA Sofa lies in the nature of relaxing. Inspired by the Mediterranean Sea, the shape evokes the sensation of drifting in calm waves. At home, the feeling is cultivated through a state-of-the-art memory foam based on research from space technology. Extremely durable and yet ultra soft, OLA will adjust to every shape with gentle tenderness. Offering a previously unknown comfort, which will set new standards. A modular system that combines flexibility, simplicity and yet rigor to details: OLA Sofa, Lounge Chair and Pouf. In line with that philosophy, removable covers are made of the highest quality fabrics. OLA marks the first collaboration between the Barcelona-based design studio Six N. Five and the Berlin furniture brand OUT. The collection intends to build up a bridge that celebrates the contrast and attraction between the two European cities.

DESIGN

Six N. Five Objects, 2021

MATERIAL

Corpus made of plywood, Nosag springs, polyfoam, and memoryfoam, plastic glides

Dimensions

OLA Sofa Lounge Chair

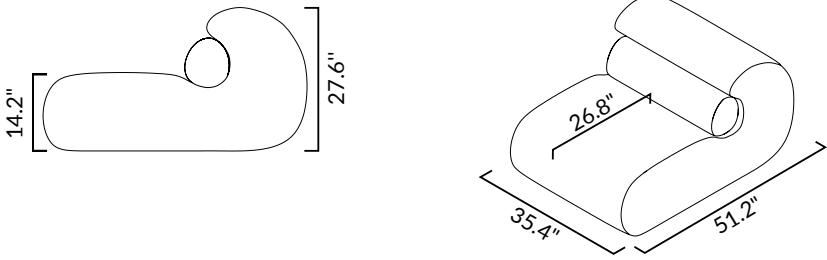

OLA Sofa Pouf



OLA Sofa Corner

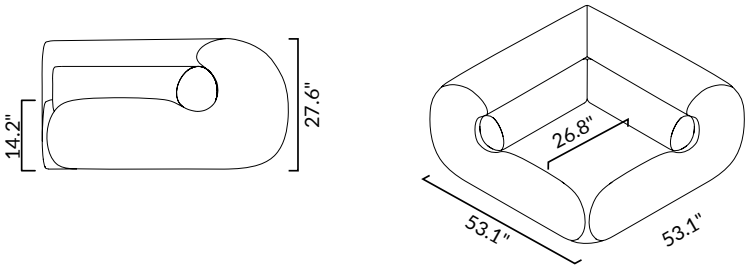

OLA Sofa 2-Seater

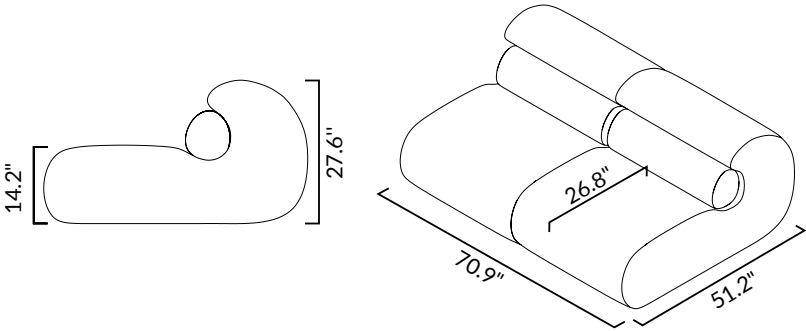

OLA Sofa 3-Seater

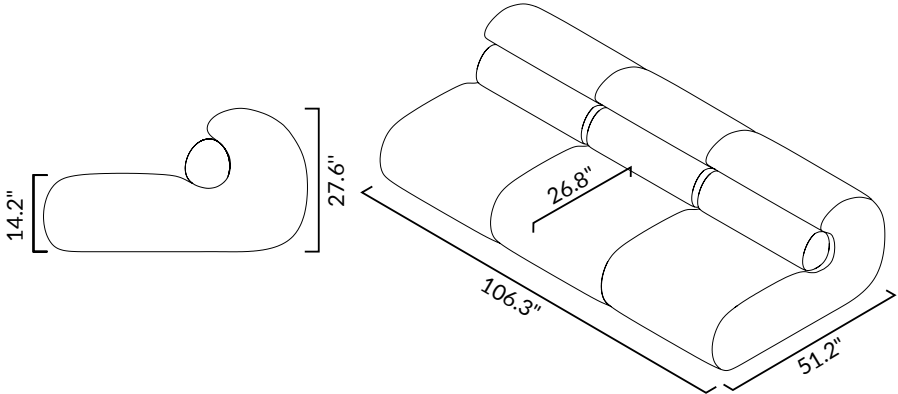









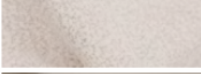

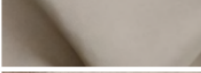



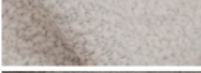



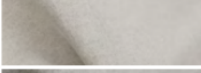

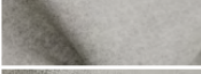

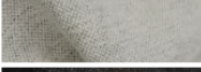

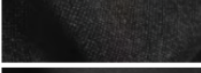











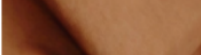

UPHOLSTERY PROGRAM

	Pure orange (Vidar 4 0542 by Kvadrat/Raf Simons)		Ivory (Berlin 121 by OUT)
	Black/White (Tiger Mountain Col. 001 by Dedar)		Beige (Seoul 141 by OUT)
	Blush (Vidar 4 0526 by Kvadrat/Raf Simons)		Sand (Hug Me 071 by Chivasso)
	Pink (Vidar 4 0622 by Kvadrat/Raf Simons)		Cream (Nimbus Col. 007 by Dedar)
	Maroon (A Perfect Flower Col. 005 by Dedar)		Stone gray (Berlin 801 by OUT)
	Plum (Phoenix 541 by OUT)		Cream (Lyon 121 by OUT)
	Pink/Green (Tiger Beat Col. 005 by Dedar)		Light gray (Phoenix 161 by OUT)
	Emerald (Vidar 4 0932 by Kvadrat/Raf Simons)		Ash gray (Hallingdal 65 0110 by Kvadrat)
	Sencha (Xtreme YS045 by Camira)		Anthracite (Hallingdal 65 0180 by Kvadrat)
	Fir green (Vidar 4 1062 by Kvadrat/Raf Simons)		Anthracite (Lyon 841 by OUT)
	Olive green (Vidar 4 0956 by Kvadrat/Raf Simons)		Dark gray (Seoul 821 by OUT)
	Moos green (Hug Me 032 by Chivasso)		Copper (Phoenix 321 by OUT)
	Lilac blue (Vidar 4 0723 by Kvadrat/Raf Simons)		Pine (Phoenix 761 by OUT)
	Light blue (Xtreme YS173 by Camira)		Amber (A Perfect Flower Col. 008 by Dedar)
	Cobalt blue (Berlin 641 by OUT)		Mustard (A Perfect Flower Col. 009 by Dedar)
	Midnight blue (Xtreme YS024 by Camira)		Leather Dunes anthracite (Sørensen Leather)
	Ultraviolet (Hallingdal 65 0763 by Kvadrat)		Leather Dunes cognac (Sørensen Leather)

Recommended standard fabric options

The OUT collection is available in any fabric or leather from our upholstery program with standard lead time.

In case you have selected a fabric or leather that is not listed in our upholstery program, the order will be processed under customer's own material (COM) / customer's own leather (COL).

We reserve the right to refuse requests due to insufficient feasibility.