

TA23 KAZIMIR



TISCH / TABLE
DESIGN: PHILIPP MAINZER, 2017

Inspired by the compositions of Suprematism, table KAZIMIR features a bold mix of geometric forms and materials and allows for a multitude of interpretations in private and public spaces. KAZIMIR is also available in a 'RAW' version.

Inspired by Suprematist compositions, table KAZIMIR features a bold mix of geometric forms and materials and allows for a multitude of interpretations in private and public spaces. KAZIMIR is also available in a 'RAW' version.



TA23 KAZIMIR

TISCH / TABLE
DESIGN: PHILIPP MAINZER, 2017

Die Tischplatte ist in Eiche und Nussbaum als Standard-Version oder als RAW-Version mit 250 mm breiten Holzbrettern und geschliffener baumkante erhältlich. /

Table top in oak and walnut is available in standard version or in raw version with solid wood boards with a width of up to 250 mm and a brushed natural edge.

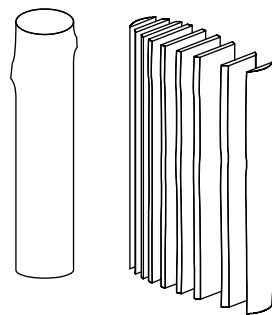

TA23 KAZIMIR

TA23 KAZIMIR RAW

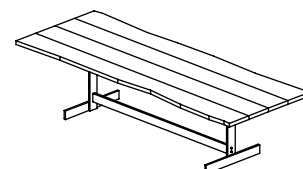
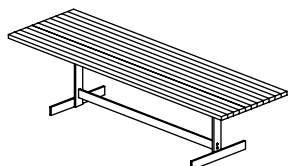
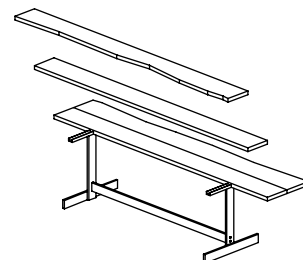
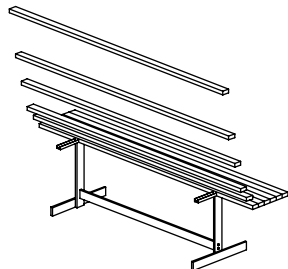
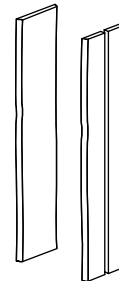
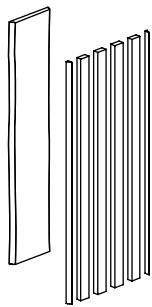

TISCH / TABLE
DESIGN: PHILIPP MAINZER, 2017

DETAILS / DETAILS

- Stärke der Tischplatte aus Massivholz beträgt 40 mm
- Tischplatte von KAZIMIR RAW besteht aus vier 250 mm breiten Holzbrettern mit roher Baumkante
- Geliefert zerlegt
- Sonderanfertigung bis 7200 mm
- Optional auch mit einer Kabelmanagementlösung erhältlich, siehe Seite 41
- Lieferzeit 12 Wochen

- Thickness of table top from solid wood measures 40 mm (1 5/8 inch)
- Table top of KAZIMIR RAW is made from four solid wood boards with a width of 250 mm (9 7/8 inch) exposing the natural edge
- Delivered disassemble
- Sonderanfertigung bis 7200 mm
- Also available with a wire management solution, see page 41
- Delivery time 12 weeks

MASSE / MEASUREMENTS

HÖHE / HEIGHT

750 MM (29 1/2 INCH)
750 MM (29 1/2 INCH)
750 MM (29 1/2 INCH)
750 MM (29 1/2 INCH)
750 MM (29 1/2 INCH)
750 MM (29 1/2 INCH)
750 MM (29 1/2 INCH)

BREITE / WIDTH

1000 MM (39 3/8 INCH)
1000 MM (39 3/8 INCH)
1000 MM (39 3/8 INCH)
1000 MM (39 3/8 INCH)
1000 MM (39 3/8 INCH)
1000 MM (39 3/8 INCH)
1000 MM (39 3/8 INCH)

LÄNGE / LENGTH

2000 MM (78 3/4 INCH)
2300 MM (90 1/2 INCH)
2500 MM (98 1/2 INCH)
2700 MM (106 1/4 INCH)
3000 MM (118 1/8 INCH)
3300 MM (130 INCH)
3600 MM (141 3/4 INCH)

MATERIAL OBERFLÄCHE / MATERIAL FINISH



EICHE, GEÖLT /
OAK, OILED



NUSSBAUM, GEÖLT /
WALNUT, OILED



EICHE, WEISS PIGMENTIERT /
OAK, WHITE PIGMENTED

MATERIAL UNTERGESTELL / MATERIAL LOWER FRAME



ALUMINIUM, TIEFSCHWARZ PULVERBESCHICHTET /
ALUMINIUM, JET BLACK POWDER-COATED



ALUMINIUM, SEIDENGRAU PULVERBESCHICHTET /
ALUMINIUM, SILK GREY POWDER-COATED



ALUMINIUM, REINORANGE PULVERBESCHICHTET /
ALUMINIUM, PURE ORANGE POWDER-COATED



ALUMINIUM, GELB VERZINKT /
ALUMINIUM, YELLOW ZINC-PLATED
**NUR ERHÄLTICH FÜR TISCHLÄNGE BIS 3000 MM /
ONLY AVAILABLE FOR TABLE LENGTH UP TO 3000 MM**

TA23 KAZIMIR



TISCH / TABLE
DESIGN: PHILIPP MAINZER, 2017

MASSE / MEASUREMENTS

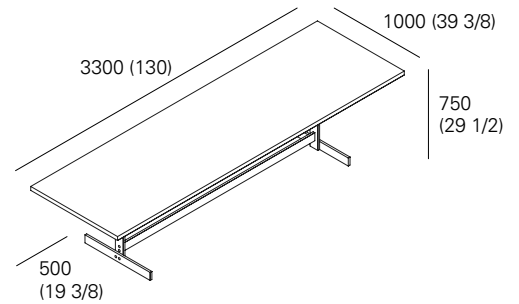
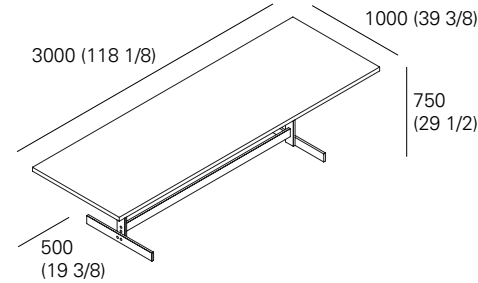
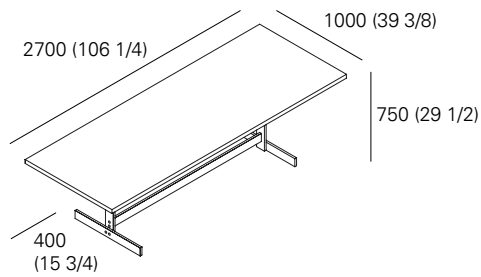
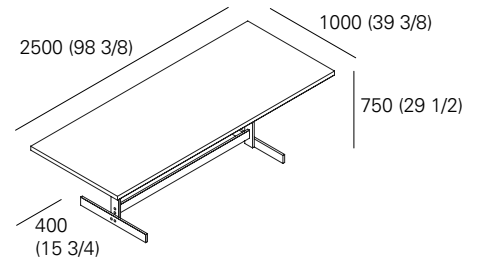
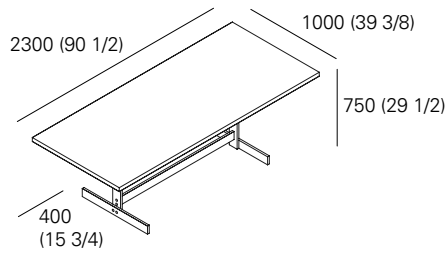
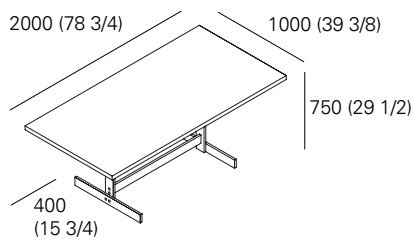

**NUR VERFÜGBAR FÜR ALUMINIUM PULVERBESCHICHTET /
ONLY FOR ALUMINIUM POWDER-COATED**

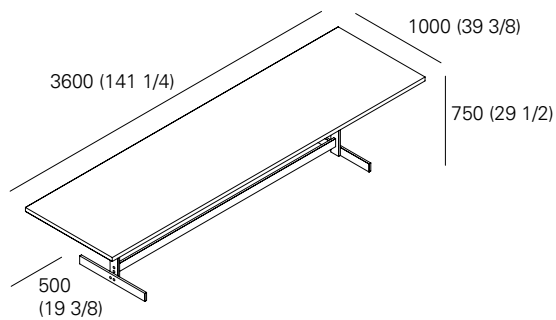

**NUR VERFÜGBAR FÜR ALUMINIUM PULVERBESCHICHTET /
ONLY FOR ALUMINIUM POWDER-COATED**

TA23 KAZIMIR TISCH / TABLE
DESIGN: PHILIPP MAINZER, 2017
NUSSBAUM, GEÖLT / WALNUT, OILED
ALUMINIUM, REINORANGE PULVERBESCHICHTET /
ALUMINIUM, PURE ORANGE POWDER-COATED

FK02 KARNAK STUHL / CHAIR
DESIGN: FERDINAND KRAMER





TA23 KAZIMIR TISCH / TABLE
DESIGN: PHILIPP MAINZER, 2017
EICHE, WEISS PIGMENTIERT, GEWACHST /
OAK, WHITE PIGMENTED, WAXED
ALUMINIUM, VERZINKT /
ALUMINIUM, ZINC PLATED

CH04 HOUDINI STUHL / CHAIR
DESIGN: STEFAN DIEZ





TA23 KAZIMIR TISCH / TABLE
DESIGN: PHILIPP MAINZER, 2017
NUSSBAUM, GEÖLT / WALNUT, OILED
ALUMINIUM, TIEFSCHWARZ PULVERBESCHICHTET /
ALUMINIUM, JET BLACK POWDER-COATED

FK02 KARNAK STUHL / CHAIR
DESIGN: FERDINAND KRAMER



TA23 KAZIMIR RAW TISCH / TABLE
DESIGN: PHILIPP MAINZER, 2017
EICHE, GEÖLT /
OAK, OILED
ALUMINIUM , PULVERBESCHICHTET, SEIDENGRAU /
ALUMINIUM, POWDER-COATED, SILK GREY

CH04 HOUDINI STUHL / CHAIR
DESIGN: STEFAN DIEZ

ST04 BACKENZAHN™ BEISTELLTISCH / SIDE TABLE
DESIGN: PHILIPP MAINZER

AC19 SALINA STEINZEUG / STONEWARE
DESIGN: E15

TA23 KAZIMIR RAW TISCH / TABLE
DESIGN: PHILIPP MAINZER, 2017
EICHE, GEÖLT / OAK, OILED
ALUMINIUM, PULVERBESCHICHTET, SEIDENGRAU /
ALUMINIUM, POWDER-COATED, SILK GREY

CH04 HOUDINI STUHL / CHAIR
DESIGN: STEFAN DIEZ

AC19 SALINA STEINZEUG / STONEWARE
DESIGN: E15

