

# SF03 SHIRAZ

SOFA / SOFA  
DESIGN: PHILIPP MAINZER, FARAH EBRAHIMI, 2006

Das Sofa SHIRAZ besticht durch sein modulares System, dem als Inspiration die kommunikationsfördernden, lose zusammengestellten persischen Sitzinseln als auch die klassischen Sitzmöbel traditioneller Salons und Hotellobbys zugrunde liegen. Das Sofa basiert auf einem flexiblen System aus Sitzelementen, Kissen und Rückenteilen, das Modernität und Tradition eindrucksvoll verbindet. /

The modular sofa SHIRAZ captivates through its modular system, whose inspiration is based on loosely conjoined communication enhancing traditional Persian seating islands as well as by classic seating furniture found in western salons and hotel lobbies. The sofa series underlies a flexible system of seating options, cushions and back parts that impressively harmonises modern and traditional elements.



Interior innovation award cologne 2007



## SOFA / SOFA

DESIGN: PHILIPP MAINZER, FARAH EBRAHIMI, 2006

### DETAILS / DETAILS

- Sitzhöhe 380 mm oder 480 mm (Basis 300 / 400 mm + Sitzkissen ca. 80 mm)
- Rückenlehnen sind demontierbar
- Alle Elemente können flexibel unter Verwendung des e15-Sofa-verbinders miteinander verbunden werden. Jeweils zwei Module können mit einem Verbinder verbunden werden.
- Alle Bezugstoffe, ausgenommen Leder, sind abnehmbar
- Aufpreis für eine feuerhemmende Ausführung der Materialien beträgt 10 % für UK und USA.

- Seating height 380 mm or 480 mm (base 300 /400 mm + seat cushion ca. 80 mm)
- Backrests are detachable
- All modules can be easily joined using the e15 sofa connector. One connector required to connect two modules.
- All fabric covers are removable, leather covers are not removable
- Surcharge for fire-resistant upholstery and cushion fillings: 10 % for UK and USA.

### MATERIAL OBERFLÄCHEN / MATERIAL FINISH



STOFF / FABRIC



LEDER / LEATHER

IN ALLEN STOFF - UND LEDERKATEGORIEN ERHÄLTlich /  
AVAILABLE IN EVERY CATEGORY OF FABRIC AND LEATHER

### MATERIAL UND KONSTRUKTION

- Bezugstoff (1)
- Gestell: Buche massiv mit Schichtholzplatten (5)
- Sitzunterfederung: Wellenfedern aus Draht mit Kunststoffmantel (3)
- Sitzpolster: Polyätherschaum (4) mit Bezug aus kaschierter Polyesterwatte (2)
- Rückenpolster: Holzplatte mit Polyätherschaum und Bezug aus Polyesterwatte
- Füllung der Kissen: Federn, Polyesterfasern
- Für USA und UK Kaschierte Polyesterwatte: Schwerentflammbar nach DIN 53 438T2

### MATERIAL AND CONSTRUCTION

- Covering fabric (1)
- Frame: Solid beech wood, plywood (5)
- Boxspring: Wave spring (wire with synthetic coating) (3)
- Seat: Polyether foam (4) with laminated Polyester foam covering (2), concealing covering from below
- Back rest: Wood, Polyether foam and Polyester foam
- Cushion filling: Feathers, Polyester fibre
- For USA and UK laminated Polyester foam: Low flammability (DIN 53 438T2)

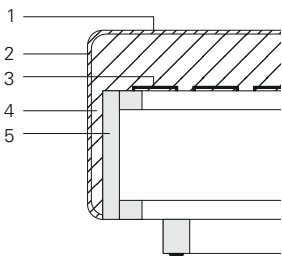

# SF03 SHIRAZ

SOFA / SOFA  
DESIGN: PHILIPP MAINZER, FARAH EBRAHIMI, 2006

ÜBERSICHT MODULE / OVERVIEW MODULES

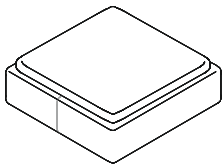

**MODUL 01 / MODULE 01**

LÄNGE / LENGTH	900 MM	(35 3/8 INCH)
TIEFE / DEPTH	900 MM	(35 3/8 INCH)
HÖHE / HEIGHT	380 MM	(15 INCH)

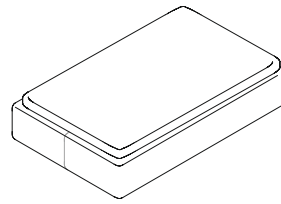

**MODUL 02 / MODULE 02**

LÄNGE / LENGTH	1350 MM	(53 1/8 INCH)
TIEFE / DEPTH	900 MM	(35 3/8 INCH)
HÖHE / HEIGHT	380 MM	(15 INCH)

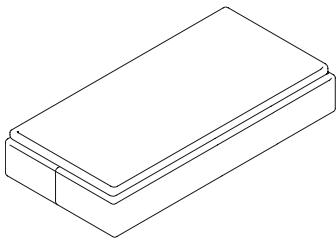

**MODUL 19 / MODULE 19**

LÄNGE / LENGTH	1800 MM	(70 3/4 INCH)
TIEFE / DEPTH	900 MM	(35 3/8 INCH)
HÖHE / HEIGHT	380 MM	(15 INCH)

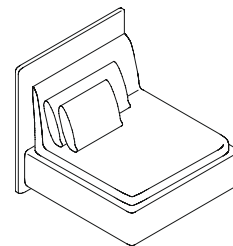

**MODUL 04 / MODULE 04**

LÄNGE / LENGTH	900 MM	(35 3/8 INCH)
TIEFE / DEPTH	960 MM	(37 3/4 INCH)
HÖHE / HEIGHT	380 MM	(15 INCH)
	850 MM	(33 1/2 INCH)

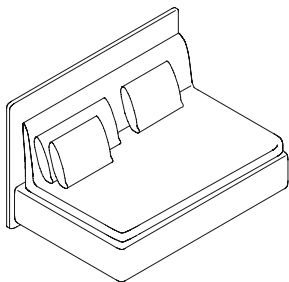

**MODUL 07 / MODULE 07**

LÄNGE / LENGTH	1350 MM	(53 1/8 INCH)
TIEFE / DEPTH	960 MM	(37 3/4 INCH)
HÖHE / HEIGHT	380 MM	(15 INCH)
	850 MM	(33 1/2 INCH)

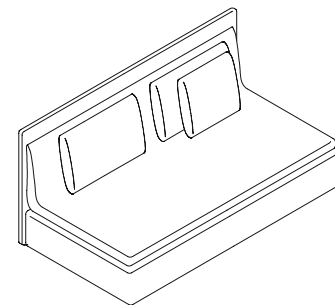

**MODUL 20 / MODULE 20**

LÄNGE / LENGTH	1800 MM	(70 3/4 INCH)
TIEFE / DEPTH	960 MM	(37 3/4 INCH)
HÖHE / HEIGHT	380 MM	(15 INCH)
	850 MM	(33 1/2 INCH)

SOFA / SOFA  
 DESIGN: PHILIPP MAINZER, FARAH EBRAHIMI, 2006

ÜBERSICHT MODULE / OVERVIEW MODULES

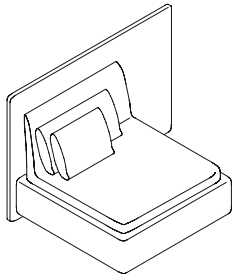

**MODUL 05 / MODULE 05**

LÄNGE / LENGTH	900 MM	(35 3/8 INCH)
	1350 MM	(53 1/8 INCH)
TIEFE / DEPTH	960 MM	(37 3/4 INCH)
HÖHE / HEIGHT	380 MM	(15 INCH)
	850 MM	(33 1/2 INCH)

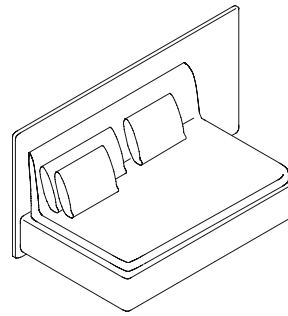

**MODUL 08 / MODULE 08**

LÄNGE / LENGTH	1350 MM	(53 1/8 INCH)
	1800 MM	(70 3/4 INCH)
TIEFE / DEPTH	960 MM	(37 3/4 INCH)
HÖHE / HEIGHT	380 MM	(15 INCH)
	850 MM	(33 1/2 INCH)

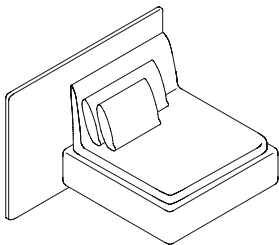

**MODUL 06 / MODULE 06**

LÄNGE / LENGTH	900 MM	(35 3/8 INCH)
	1350 MM	(53 1/8 INCH)
TIEFE / DEPTH	960 MM	(37 3/4 INCH)
HÖHE / HEIGHT	380 MM	(15 INCH)
	850 MM	(33 1/2 INCH)

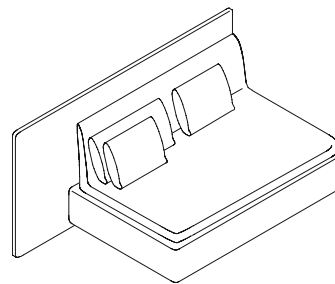

**MODUL 09 / MODULE 09**

LÄNGE / LENGTH	1350 MM	(53 1/8 INCH)
	1800 MM	(70 3/4 INCH)
TIEFE / DEPTH	960 MM	(37 3/4 INCH)
HÖHE / HEIGHT	380 MM	(15 INCH)
	850 MM	(33 1/2 INCH)

# SF03 SHIRAZ

SOFA / SOFA  
DESIGN: PHILIPP MAINZER, FARAH EBRAHIMI, 2006

ÜBERSICHT MODULE / OVERVIEW MODULES

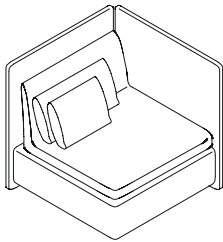

**MODUL 18 / MODULE 18**

LÄNGE / LENGTH	960 MM	(37 3/4 INCH)
TIEFE / DEPTH	960 MM	(37 3/4 INCH)
HÖHE / HEIGHT	380 MM	(15 INCH)
	850 MM	(33 1/2 INCH)

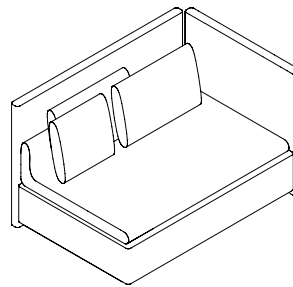

**MODUL 24 / MODULE 24**

LÄNGE / LENGTH	1410 MM	(55 1/2 INCH)
TIEFE / DEPTH	960 MM	(37 3/4 INCH)
HÖHE / HEIGHT	380 MM	(15 INCH)
	850 MM	(33 1/2 INCH)

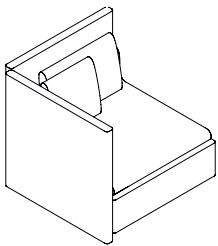

**MODUL 23 / MODULE 23**

LÄNGE / LENGTH	960 MM	(37 3/4 INCH)
TIEFE / DEPTH	960 MM	(37 3/4 INCH)
HÖHE / HEIGHT	380 MM	(15 INCH)
	850 MM	(33 1/2 INCH)

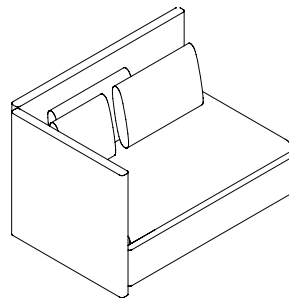

**MODUL 25 / MODULE 25**

LÄNGE / LENGTH	1410 MM	(55 1/2 INCH)
TIEFE / DEPTH	960 MM	(37 3/4 INCH)
HÖHE / HEIGHT	380 MM	(15 INCH)
	850 MM	(33 1/2 INCH)

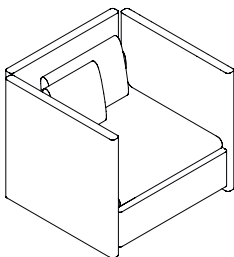

**MODUL 28 / MODULE 28**

LÄNGE / LENGTH	1020 MM	(40 1/8 INCH)
TIEFE / DEPTH	960 MM	(37 3/4 INCH)
HÖHE / HEIGHT	380 MM	(15 INCH)
	850 MM	(33 1/2 INCH)

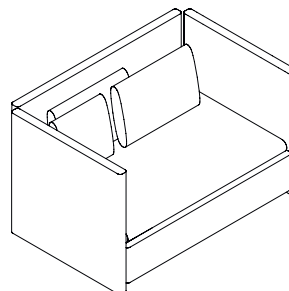

**MODUL 29 / MODULE 29**

LÄNGE / LENGTH	1470 MM	(57 7/8 INCH)
TIEFE / DEPTH	960 MM	(37 3/4 INCH)
HÖHE / HEIGHT	380 MM	(15 INCH)
	850 MM	(33 1/2 INCH)

# SF03 SHIRAZ

SOFA / SOFA  
DESIGN: PHILIPP MAINZER, FARAH EBRAHIMI, 2006

ÜBERSICHT MODULE / OVERVIEW MODULES

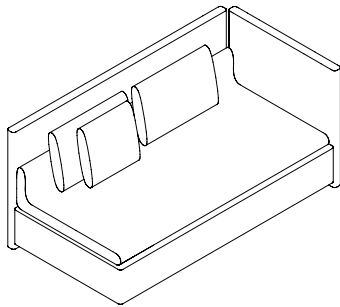

**MODUL 26 / MODULE 26**

LÄNGE / LENGTH	1860 MM	(73 1/4 INCH)
TIEFE / DEPTH	960 MM	(37 3/4 INCH)
HÖHE / HEIGHT	380 MM	(15 INCH)
	850 MM	(33 1/2 INCH)

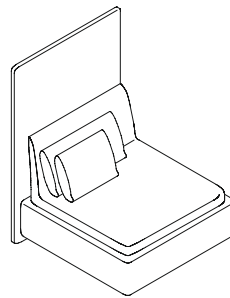

**MODUL 11 / MODULE 11**

LÄNGE / LENGTH	900 MM	(35 3/8 INCH)
TIEFE / DEPTH	960 MM	(37 3/4 INCH)
HÖHE / HEIGHT	380 MM	(15 INCH)
	1250 MM	(49 1/4 INCH)

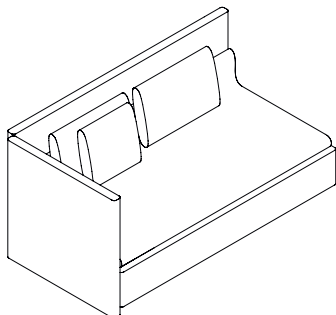

**MODUL 27 / MODULE 27**

LÄNGE / LENGTH	1860 MM	(73 1/4 INCH)
TIEFE / DEPTH	960 MM	(37 3/4 INCH)
HÖHE / HEIGHT	380 MM	(15 INCH)
	850 MM	(33 1/2 INCH)

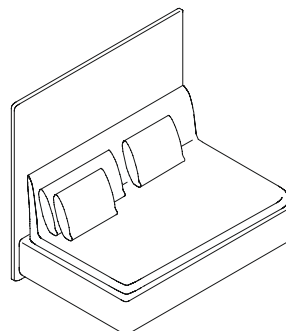

**MODUL 14 / MODULE 14**

LÄNGE / LENGTH	1350 MM	(53 1/8 INCH)
TIEFE / DEPTH	960 MM	(37 3/4 INCH)
HÖHE / HEIGHT	380 MM	(15 INCH)
	1250 MM	(49 1/4 INCH)

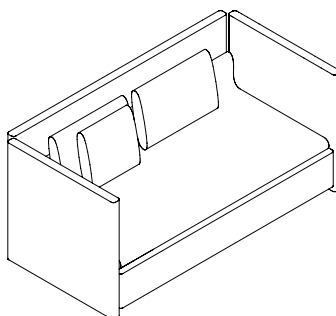

**MODUL 30 / MODULE 30**

LÄNGE / LENGTH	1920 MM	(75 3/4 INCH)
TIEFE / DEPTH	960 MM	(37 3/4 INCH)
HÖHE / HEIGHT	380 MM	(15 INCH)
	850 MM	(33 1/2 INCH)

[www.stillfried.com](http://www.stillfried.com)

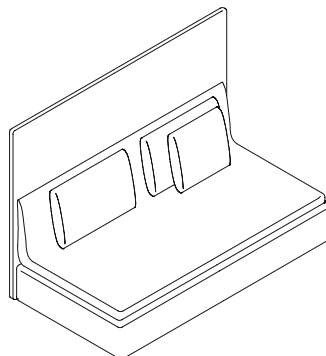

**MODUL 21 / MODULE 21**

LÄNGE / LENGTH	1800 MM	(70 3/4 INCH)
TIEFE / DEPTH	960 MM	(37 3/4 INCH)
HÖHE / HEIGHT	380 MM	(15 INCH)
	1250 MM	(49 1/4 INCH)

SOFA / SOFA  
DESIGN: PHILIPP MAINZER, FARAH EBRAHIMI, 2006

ÜBERSICHT MODULE / OVERVIEW MODULES

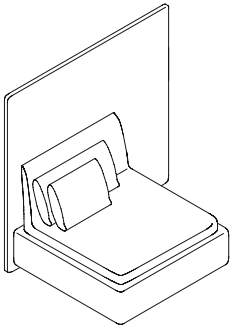

**MODUL 12 / MODULE 12**

LÄNGE / LENGTH	900 MM	(35 3/8 INCH)
	1350 MM	(53 1/8 INCH)
TIEFE / DEPTH	960 MM	(37 3/4 INCH)
HÖHE / HEIGHT	380 MM	(15 INCH)
	1250 MM	(49 1/4 INCH)

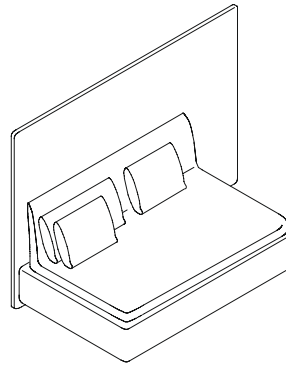

**MODUL 15 / MODULE 15**

LÄNGE / LENGTH	1350 MM	(53 1/8 INCH)
	1800 MM	(70 3/4 INCH)
TIEFE / DEPTH	960 MM	(37 3/4 INCH)
HÖHE / HEIGHT	380 MM	(15 INCH)
	1250 MM	(49 1/4 INCH)

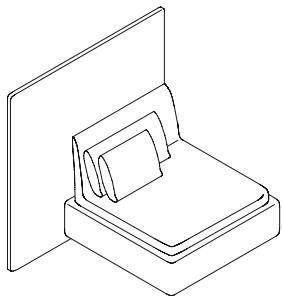

**MODUL 13 / MODULE 13**

LÄNGE / LENGTH	900 MM	(35 3/8 INCH)
	1350 MM	(53 1/8 INCH)
TIEFE / DEPTH	960 MM	(37 3/4 INCH)
HÖHE / HEIGHT	380 MM	(15 INCH)
	1250 MM	(49 1/4 INCH)

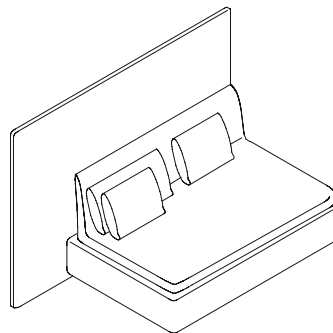

**MODUL 16 / MODULE 16**

LÄNGE / LENGTH	1350 MM	(53 1/8 INCH)
	1800 MM	(70 3/4 INCH)
TIEFE / DEPTH	960 MM	(37 3/4 INCH)
HÖHE / HEIGHT	380 MM	(15 INCH)
	1250 MM	(49 1/4 INCH)

Alle Module sind auch mit einer Sitzhöhe von 480 mm (18 7/8 inch)  
(Basis 400 mm (15 3/4 inch) + Sitzkissen 80 mm (3 1/8 inch)) erhältlich.

All modules are also available with a seating height of 480 mm (18 7/8 inch)  
(base 400 mm (15 3/4 inch) + seat cushion ca. 80 mm (3 1/8 inch)).

SOFA / SOFA  
DESIGN: PHILIPP MAINZER, FARAH EBRAHIMI, 2006

ÜBERSICHT MODULE / OVERVIEW MODULES

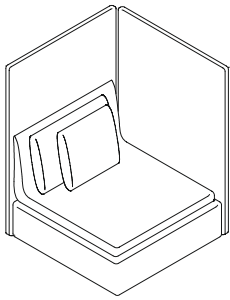

**MODUL 22 / MODULE 22**

LÄNGE / LENGTH	960 MM	(37 3/4 INCH)
TIEFE / DEPTH	960 MM	(37 3/4 INCH)
HÖHE / HEIGHT	380 MM	(15 INCH)
	1250 MM	(49 1/4 INCH)

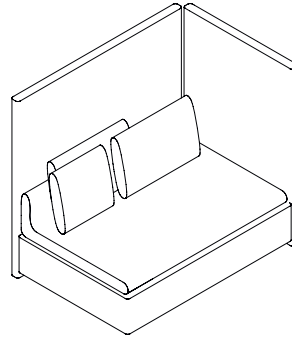

**MODUL 32 / MODULE 32**

LÄNGE / LENGTH	1410 MM	(55 1/2 INCH)
TIEFE / DEPTH	960 MM	(37 3/4 INCH)
HÖHE / HEIGHT	380 MM	(15 INCH)
	1250 MM	(49 1/4 INCH)

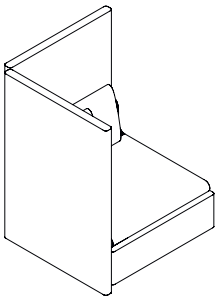

**MODUL 31 / MODULE 31**

LÄNGE / LENGTH	960 MM	(37 3/4 INCH)
TIEFE / DEPTH	960 MM	(37 3/4 INCH)
HÖHE / HEIGHT	380 MM	(15 INCH)
	1250 MM	(49 1/4 INCH)

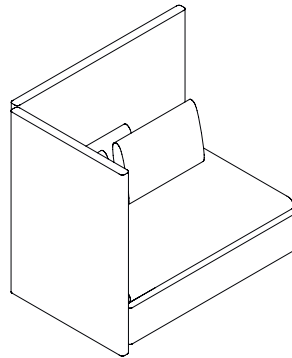

**MODUL 33 / MODULE 33**

LÄNGE / LENGTH	1410 MM	(55 1/2 INCH)
TIEFE / DEPTH	960 MM	(37 3/4 INCH)
HÖHE / HEIGHT	380 MM	(15 INCH)
	1250 MM	(49 1/4 INCH)

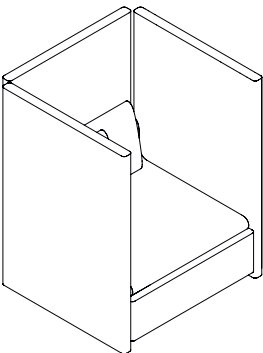

**MODUL 36 / MODULE 36**

LÄNGE / LENGTH	1020 MM	(40 1/8 INCH)
TIEFE / DEPTH	960 MM	(37 3/4 INCH)
HÖHE / HEIGHT	380 MM	(15 INCH)
	1250 MM	(49 1/4 INCH)

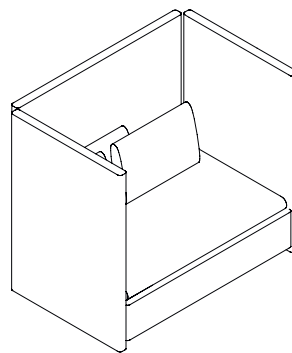

**MODUL 37 / MODULE 37**

LÄNGE / LENGTH	1470 MM	(57 7/8 INCH)
TIEFE / DEPTH	960 MM	(37 3/4 INCH)
HÖHE / HEIGHT	380 MM	(15 INCH)
	1250 MM	(49 1/4 INCH)



# SF03 SHIRAZ

SOFA / SOFA  
DESIGN: PHILIPP MAINZER, FARAH EBRAHIMI, 2006

ÜBERSICHT MODULE / OVERVIEW MODULES

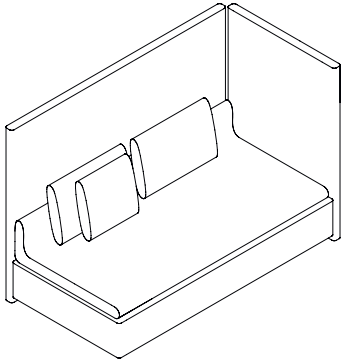

#### MODUL 34 / MODULE 34

LÄNGE / LENGTH	1860 MM	(73 1/4 INCH)
TIEFE / DEPTH	960 MM	(37 3/4 INCH)
HÖHE / HEIGHT	380 MM	(15 INCH)
	1250 MM	(49 1/4 INCH)

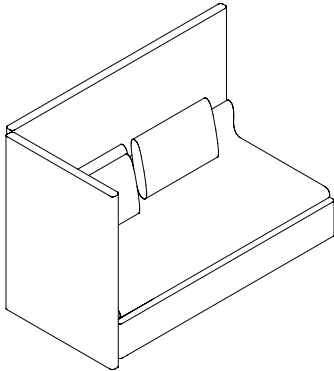

#### MODUL 35 / MODULE 35

LÄNGE / LENGTH	1860 MM	(73 1/4 INCH)
TIEFE / DEPTH	960 MM	(37 3/4 INCH)
HÖHE / HEIGHT	380 MM	(15 INCH)
	1250 MM	(49 1/4 INCH)

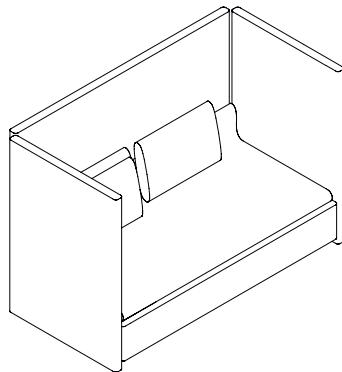

#### MODUL 38 / MODULE 38

LÄNGE / LENGTH	1920 MM	(73 1/4 INCH)
TIEFE / DEPTH	960 MM	(37 3/4 INCH)
HÖHE / HEIGHT	380 MM	(15 INCH)
	1250 MM	(49 1/4 INCH)



**SF03 SHIRAZ** SOFA / SOFA  
 DESIGN: PHILIPP MAINZER, FARAH EBRAHIMI, 2006  
 STOFF / FABRIC: TWILL WEAVE, SILK GREY

**CU06 NIMA** WURFKISSEN / CUSHION

**EC06 ILMA** SESSEL / LOUNGE CHAIR

**DT02 TORE** BEISTELLTISCH / SIDE TABLE

**CT09 ENOKI METAL** BEISTELLTISCH / SIDE TABLE

**CP03 KAVIR** TEPPICH / CARPET

**SF03 SHIRAZ** SOFA / SOFA  
 DESIGN: PHILIPP MAINZER, FARAH EBRAHIMI, 2006  
 STOFF / FABRIC: TWILL WEAVE, SILK GREY

**CU06 NIMA** WURFKISSEN / CUSHION

**EC06 ILMA** SESSEL / LOUNGE CHAIR

**DT02 TORE** BEISTELLTISCH / SIDE TABLE

**CP03 KAVIR** TEPPICH / CARPET





**SF03 SHIRAZ** SOFA / SOFA  
DESIGN: PHILIPP MAINZER, FARAH EBRAHIMI, 2006  
STOFF / FABRIC: BYRAM OCHRE

**CU06 NIMA** WURFKISSEN / CUSHION

**ST04 BACKENZAHN™** BEISTELLTISCH / SIDE TABLE

**CM02 HABIBI** BEISTELLTISCH / SIDE TABLE

**CP03 KAVIR** TEPPICH / CARPET



**SF03 SHIRAZ** SOFA / SOFA  
DESIGN: PHILIPP MAINZER, FARAH EBRAHIMI, 2006  
STOFF / FABRIC: LOUPO BLACK

**CU06 NIMA** WURFKISSEN / CUSHION

**EC06 ILMA** SESSEL / LOUNGE CHAIR

**DT02 TORE** BEISTELLTISCH / SIDE TABLE

**CT09 ENOKI METAL** BEISTELLTISCH / SIDE TABLE

**CP03 KAVIR** TEPPICH / CARPET





**SF03 SHIRAZ** SOFA / SOFA  
 DESIGN: PHILIPP MAINZER, FARAH EBRAHIMI, 2006  
 STOFF / FABRIC: BRASIL ECRU  
 STOFF / FABRIC: BYRAM ESPRESSO

**CU06 NIMA** WURFKISSEN / CUSHION

**ST04 BACKENZAHN™** BEISTELLTISCH / SIDE TABLE

**DT02 TORE** BEISTELLTISCH / SIDE TABLE

**CP03 KAVIR** TEPPICH / CARPET

**SF03 SHIRAZ** SOFA / SOFA  
 DESIGN: PHILIPP MAINZER, FARAH EBRAHIMI, 2006  
 STOFF / FABRIC: BYRAM ESPRESSO

**CU06 NIMA** WURFKISSEN / CUSHION

**CT09 ENOKI METAL** BEISTELLTISCH / SIDE TABLE

**CP03 KAVIR** TEPPICH / CARPET



**SF03 SHIRAZ** SOFA / SOFA  
DESIGN: PHILIPP MAINZER, FARAH EBRAHIMI, 2006  
STOFF / FABRIC: BRASIL ECRU

**DT02 TORE** BEISTELLTISCH / SIDE TABLE



**SF03 SHIRAZ** SOFA / SOFA  
DESIGN: PHILIPP MAINZER, FARAH EBRAHIMI, 2006  
STOFF / FABRIC: BRASIL ECRU

**DT02 TORE** BEISTELLTISCH / SIDE TABLE

**CM02 HABIBI** BEISTELLTISCH / SIDE TABLE



**SF03 SHIRAZ** SOFA / SOFA  
DESIGN: PHILIPP MAINZER, FARAH EBRAHIMI, 2006  
STOFF / FABRIC: LAMA CARBON, ERSKINE BLACK & WHITE

**CU06 NIMA** WURFKISSEN / CUSHION

**PA03 ALEX** BEISTELLTISCH / SIDE TABLE





**SF03 SHIRAZ** SOFA / SOFA  
 DESIGN: PHILIPP MAINZER, FARAH EBRAHIMI, 2006  
 STOFF / FABRIC: PARIS TEXAS, SAND

**CU06 NIMA** WURFKISSEN / CUSHION

**PA03 ALEX** BEISTELLTISCH / SIDE TABLE

**CM02 HABIBI** TABLETT / TRAY

**SF03 SHIRAZ** SOFA / SOFA  
 DESIGN: PHILIPP MAINZER, FARAH EBRAHIMI, 2006  
 STOFF / FABRIC: LAMA, CARBON

**CU06 NIMA** WURFKISSEN / CUSHION

**PA03 ALEX** BEISTELLTISCH / SIDE TABLE

**CM02 HABIBI** TABLETT / TRAY





**STOFFE / FABRICS**

**FIELD\***

(STOFFGRUPPE B / FABRIC GROUP B)  
KVADRAT

QUALITÄT / CONTENT  
100% TREVIRA CS / TREVIRA CS

SCHEUERFESTIGKEIT / RUB RESISTANCE  
100.000 MARTINDALE

LICHTECHTHEIT / FASTNESS TO LIGHT  
TYP 5-7, ISO 1-8

FLAMMSCHUTZ / FLAME RESISTANCE  
EN 1021-1/2, DIN 4102, B1

BREITE / WIDTH  
1400 MM (55 1/8 INCH)

GEWICHT PRO QM / WEIGHT PER SQM  
430 GR

PFLEGEANLEITUNG / CARE INSTRUCTIONS

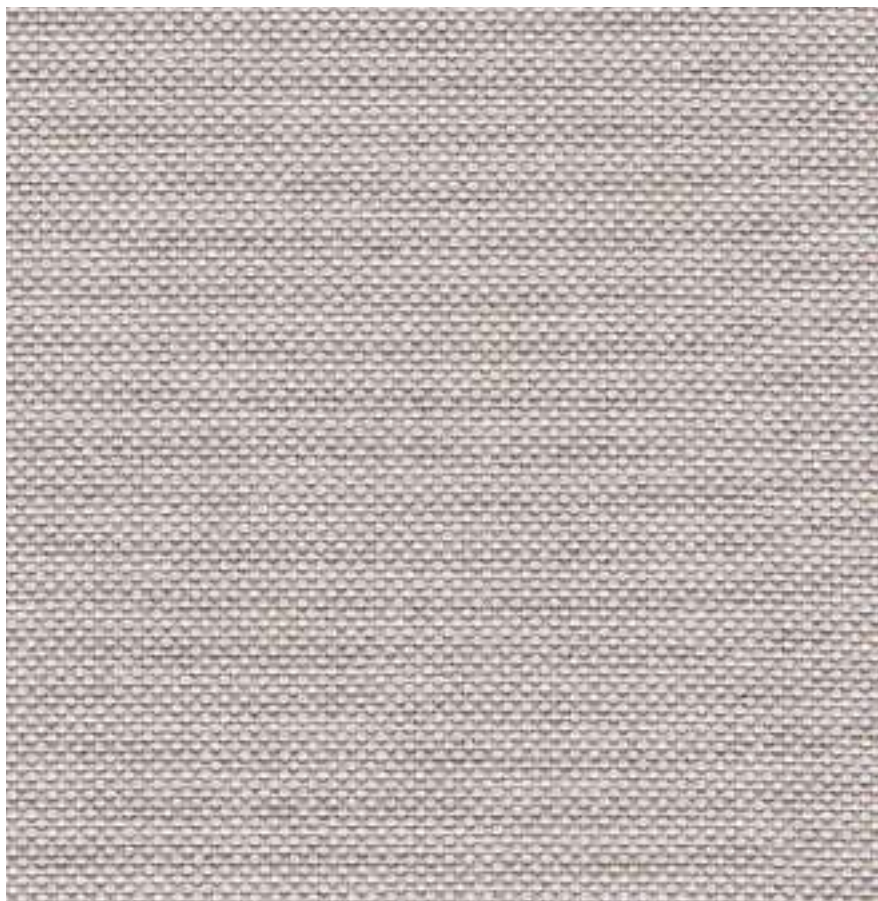

FIELD, SILK GREY 123



FIELD, CHESS 142

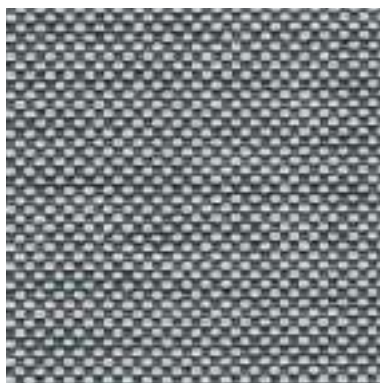

FIELD, STONE 132

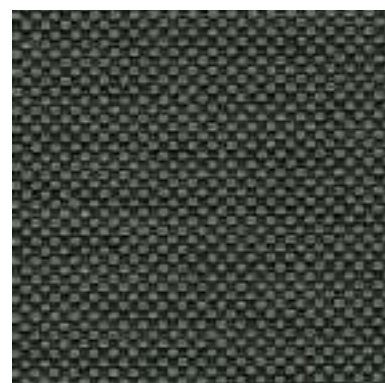

FIELD, GRAPHITE 182



FIELD, MIDNIGHT 782

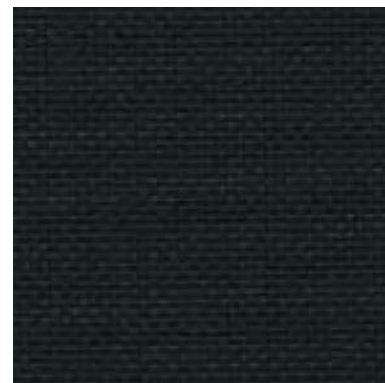

FIELD, BLACK 192

## STOFFE / FABRICS

### ANTWERP

(STOFFGRUPPE B / FABRIC GROUP B)

QUALITÄT / CONTENT  
100% LEINEN / LINEN

SCHEUERFESTIGKEIT / RUB RESISTANCE  
25.000 MARTINDALE

LICHTECHTHEIT / FASTNESS TO LIGHT  
-

FLAMMSCHUTZ / FLAME RESISTANCE  
-

BREITE /WIDTH  
1500 MM (59 INCH)

GEWICHT PRO QM /WEIGHT PER SQM  
700 GR

PFLEGEANLEITUNG / CARE INSTRUCTIONS



ANTWERP IST EIN HOCHQUALITATIVER, BELGISCHER LEINENSTOFF, DER EINEM EXKLUSIVEN FÄRBEVERFAHREN UNTERZOGEN WIRD, UM DAS GWÜNSCHTE „VERWITTERTE AUSSEHEN“ ZU ERREICHEN. BITTE BEACHTEN SIE, DASS DUNKLE UND MITTLERE TÖNE SICH DURCH TROCKENES ODER FEUCHTES REIBEN VERFÄRBN. / ANTWERP IS A HIGH QUALITY BELGIAN LINEN WHICH IS TREATED WITH AN EXCLUSIVE DYE PROCESS TO ACHIEVE A DESIRED „WEATHERED LOOK“. MEDIUM TO DARK SHADES WILL DEFILY BY DRY AND WET RUBBING.



ANTWERP, OYSTER 13247



ANTWERP, SMOKE 13242



ANTWERP. CARBON 13274

## STOFFE / FABRICS

### SIERRA

(STOFFGRUPPE B / FABRIC GROUP B)

QUALITÄT / CONTENT  
100% LEINEN / LINEN

SCHEUERFESTIGKEIT / RUB RESISTANCE  
25.000 MARTINDALE

LICHTTECHTHEIT / FASTNESS TO LIGHT  
-

FLAMMSCHUTZ / FLAME RESISTANCE  
-

BREITE / WIDTH  
1450 MM (57 INCH)

GEWICHT PRO QM / WEIGHT PER SQM  
1000 GR

PFLEGEANLEITUNG / CARE INSTRUCTIONS



SIERRA IST EIN HOCHQUALITATIVER, BELGISCHER LEINENSTOFF, DER EINEM EXKLUSIVEM FÄRBEVERFAHREN UNTERZOGEN WIRD, UM DAS GWÜNSCHTE „VERWITTERTE AUSSEHEN“ ZU ERREICHEN. BITTE BEACHTEN SIE, DASS DUNKLE UND MITTLERE TÖNE SICH DURCH TROCKENES ODER FEUCHTES REIBEN VERFÄRBN. / SIERRA IS A HIGH QUALITY BELGIAN LINEN WHICH IS TREATED WITH AN EXCLUSIVE DYE PROCESS TO ACHIEVE A DESIRED „WEATHERED LOOK“. MEDIUM TO DARK SHADES WILL DEFILE BY DRY AND WET RUBBING.



SIERRA PENGUIN 13601



SIERRA, MIDNIGHT 13619

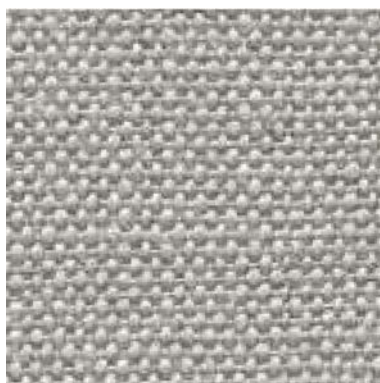

SIERRA, STERLING 13617



SIERRA SKY 13603

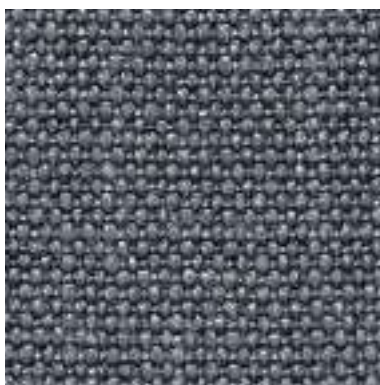

SIERRA, GRAPHITE 136004



SIERRA ESPRESSO 13612

**STOFFE / FABRICS**

**PARIS TEXAS**

(STOFFGRUPPE B / FABRIC GROUP B)

**QUALITÄT / CONTENT**

63% BAUMWOLLE / COTTON,  
37% LEINEN / LINEN

**SCHEUERFESTIGKEIT / RUB RESISTANCE**

36.000 MARTINDALE

**LICHTECHTHEIT / FASTNESS TO LIGHT**

-

**FLAMMSCHUTZ / FLAME RESISTANCE**

M1, BS5897, BS5852, BS7175  
EN1021-1/2, EN13772

**BREITE / WIDTH**

1400 MM (55 1/8 INCH)

**GEWICHT PRO QM / WEIGHT PER SQM**

380 GR

**PFLEGEANLEITUNG / CARE INSTRUCTIONS**



PARIS TEXAS, STERLING 9922

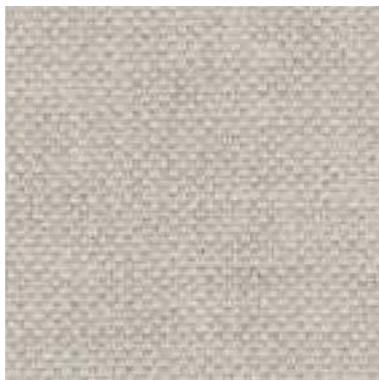

PARIS TEXAS, SAND 0594



PARIS TEXAS, SMOKE 7568



PARIS TEXAS, ESPRESSO 1044

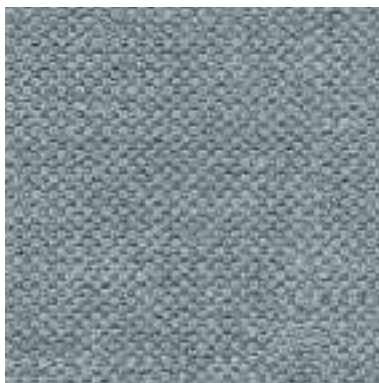

PARIS TEXAS, SLATE 3371



PARIS TEXAS, INK 8753



PARIS TEXAS, CARBON 2049

## STOFFE / FABRICS

### LOUPO

(STOFFGRUPPE C / FABRIC GROUP C)

#### QUALITÄT / CONTENT

36% WOLLE / WOOL,  
34% BAUMWOLLE / COTTON,  
22% VISKOSE / VISCOSE,  
8% POLYESTER / POLYESTER

SCHEUERFESTIGKEIT / RUB RESISTANCE  
45.000 MARTINDALE

LICHTECHTHEIT / FASTNESS TO LIGHT  
TYP 4

FLAMMSCHUTZ / FLAME RESISTANCE  
-

BREITE / WIDTH  
1400 MM (55 1/8 INCH)

GEWICHT PRO QM / WEIGHT PER SQM  
584 GR

#### PFLEGEANLEITUNG / CARE INSTRUCTIONS



LOUPO, BALTIC



LOUPO, BLACK



LOUPO, CHARCOAL

## STOFFE / FABRICS

### BRASILIA

(STOFFGRUPPE C / FABRIC GROUP C)

#### QUALITÄT / CONTENT

23% LEINEN / LINEN,  
20% BAUMWOLLE / COTTON,  
20% WOLLE / WOOL,  
19% POLYAMID / POLYAMIDE,  
11% SEIDE / SILK,  
7% BAMBUS / BAMBOO

SCHEUERFESTIGKEIT / RUB RESISTANCE  
40.000 MARTINDALE

LICHTECHTHEIT / FASTNESS TO LIGHT  
TYP 4-5, ISO 12947-2

FLAMMSCHUTZ / FLAME RESISTANCE  
-

BREITE / WIDTH  
1300 MM (51 1/8 INCH)

GEWICHT PRO QM / WEIGHT PER SQM  
494 GR

#### PFLEGEANLEITUNG / CARE INSTRUCTIONS



BRASILIA, MULTI



BRASILIA ECRU



BRASILIA, AZUL

### LAMA

(STOFFGRUPPE C / FABRIC GROUP C)

#### QUALITÄT / CONTENT

65% WOLLE / WOOL,  
20% NYLON / NYLON,  
15% ALPAKA / ALPACA

SCHEUERFESTIGKEIT / RUB RESISTANCE  
100.000 MARTINDALE

LICHTECHTHEIT / FASTNESS TO LIGHT  
TYP 4-5

FLAMMSCHUTZ / FLAME RESISTANCE  
-

BREITE / WIDTH  
1400 MM (55 1/8 INCH)

GEWICHT PRO QM / WEIGHT PER SQM  
600 GR

#### PFLEGEANLEITUNG / CARE INSTRUCTIONS



LAMA, STONE 8



LAMA, CARBON 5



LAMA, OYSTER 801

## STOFFE / FABRICS

### TARTAN

(STOFFGRUPPE D / FABRIC GROUP D)

QUALITÄT / CONTENT  
100% WOLLE / WOOL

SCHEUERFESTIGKEIT / RUB RESISTANCE  
40.000 MARTINDALE

LICHTECHTHEIT / FASTNESS TO LIGHT  
-

FLAMMSCHUTZ / FLAME RESISTANCE  
-

BREITE / WIDTH  
1400 MM (55 1/8 INCH)

GEWICHT PRO QM / WEIGHT PER SQM  
380-515 GR

PFLEGEANLEITUNG / CARE INSTRUCTION



ANCIENT ANGUS



ERSKINE BLACK AND WHITE



CORNISH NATIONAL

### INTRECCIO

(STOFFGRUPPE D / FABRIC GROUP D)

QUALITÄT / CONTENT  
77% SCHURWOLLE / NEW WOOL,  
23 % BAUMWOLLE / COTTON

SCHEUERFESTIGKEIT / RUB RESISTANCE  
80.000 MARTINDALE

LICHTECHTHEIT / FASTNESS TO LIGHT  
-

FLAMMSCHUTZ / FLAME RESISTANCE  
-

BREITE / WIDTH  
1400 MM (55 1/8 INCH)

GEWICHT PRO QM / WEIGHT PER SQM  
777 GR

PFLEGEANLEITUNG / CARE INSTRUCTIONS



INTRECCIO 16



INTRECCIO 17

## STOFFE / FABRICS

### BALBOA

(STOFFGRUPPE D / FABRIC GROUP D)  
KVADRAT

QUALITÄT / CONTENT  
100% POLYESTER FR / POLYESTER FR

SCHEUERFESTIGKEIT / RUB RESISTANCE  
100.000 MARTINDALE

LICHTTECHTHEIT / FASTNESS TO LIGHT  
TYP 6

FLAMMSCHUTZ / FLAME RESISTANCE  
EN 1021-1/2, BS 5852, DIN 4102, B1

BREITE / WIDTH  
1400 MM (55 1/8 INCH)

GEWICHT PRO QM / WEIGHT PER SQM  
960 GR

PFLEGEANLEITUNG / CARE INSTRUCTIONS

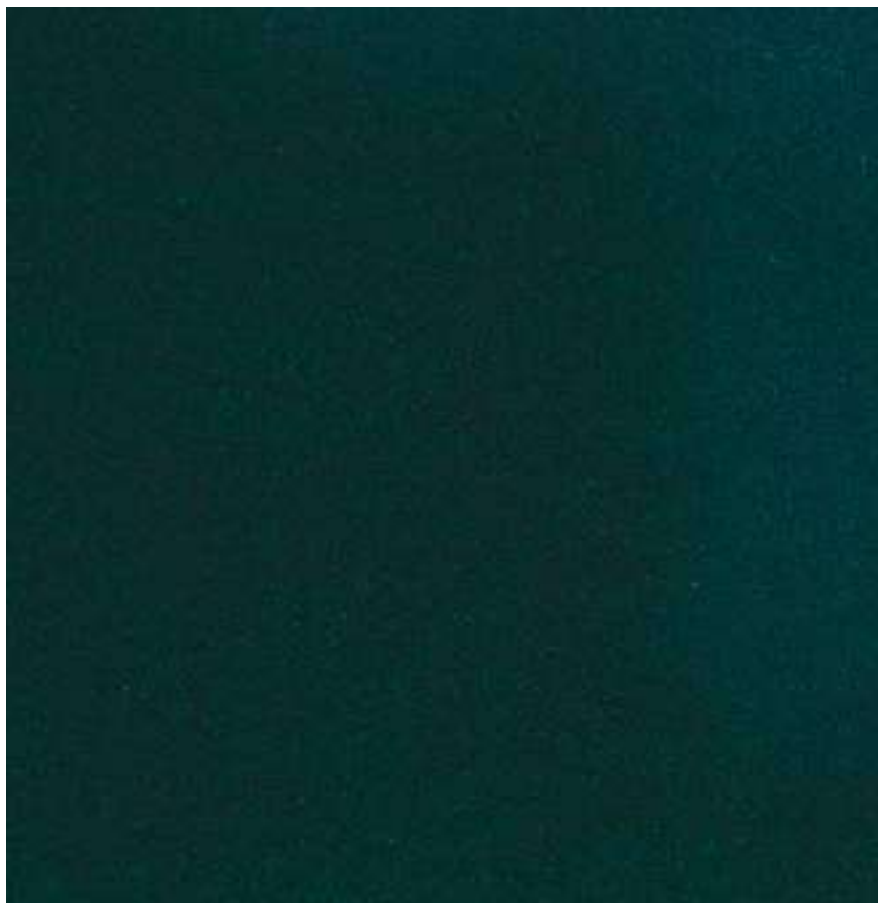

BALBOA, CYPRESS GREEN 12



BALBOA, POMEGRANATE 01



BALBOA, ESPRESSO 29



BALBOA, MIDNIGHT BLUE 19

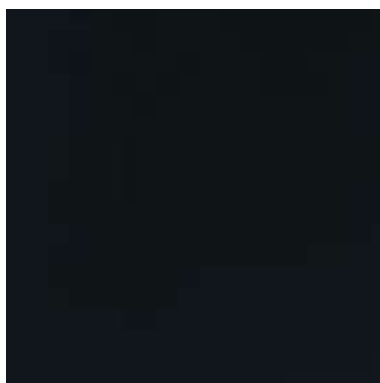

BALBOA, BLACK 30



BALBOA, OYSTER 27



## STOFFE / FABRICS

### DIVINA

(STOFFGRUPPE D / FABRIC GROUP D)  
KVADRAT

QUALITÄT / CONTENT  
100% SCHURWOLLE / NEWWOOL

SCHEUERFESTIGKEIT / RUB RESISTANCE  
45.000 MARTINDALE

LICHTECHTHEIT / FASTNESS TO LIGHT  
TYP 5-7, ISO 105-B02

FLAMMSCHUTZ / FLAME RESISTANCE  
EN 1021-1/2, BS 5852

BREITE / WIDTH  
1500 MM (59 INCH)

GEWICHT PRO QM / WEIGHT PER SQM  
820 GR

PFLEGEANLEITUNG / CARE INSTRUCTIONS

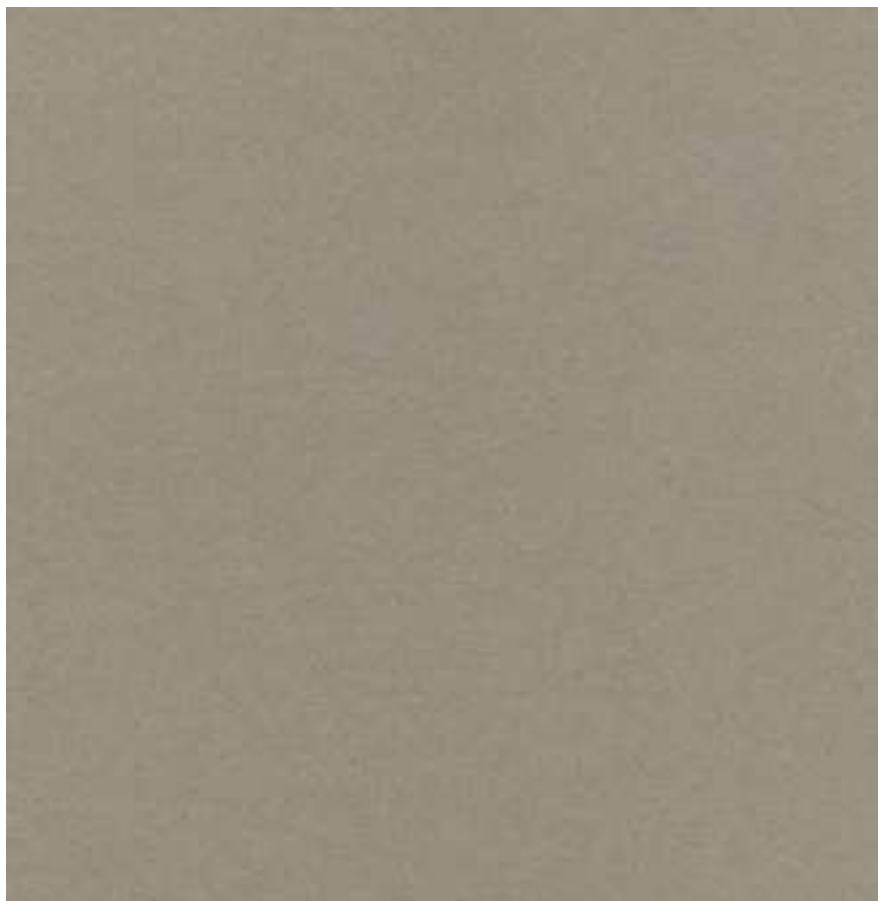

DIVINA, 224 MOCCA

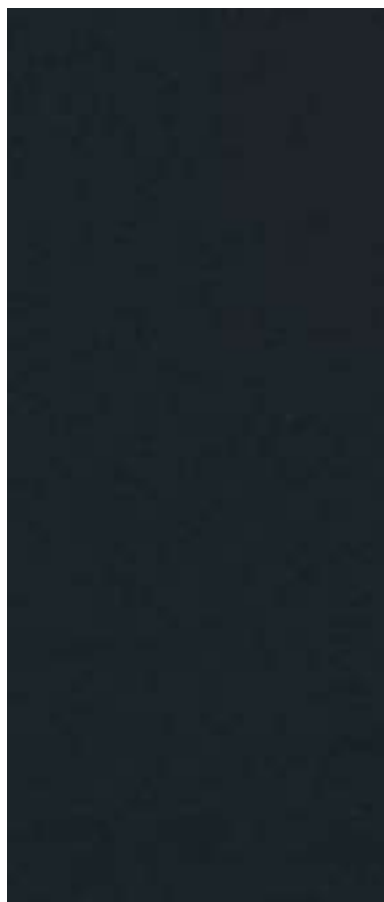

DIVINA, 191 BLACK



DIVINA, 626 FLAMINGO



DIVINA, 666 FUCHSIA



DIVINA, 756 ULTRAMARINE



DIVINA, 782 LAPIS

## STOFFE / FABRICS

### VIDAR<sup>+</sup>

(STOFFGRUPPE D / FABRIC GROUP D  
KVADRAT

QUALITÄT / CONTENT  
94% SCHURWOLLE / NEW WOOL,  
6% POLYAMID / POLYAMIDE

SCHEUERFESTIGKEIT / RUB RESISTANCE  
100.000 MARTINDALE

LICHTECHTHEIT / FASTNESS TO LIGHT  
TYP 6-7, ISO 105-B02

FLAMMSCHUTZ / FLAME RESISTANCE  
EN 1021-1/2, BS 5852

BREITE / WIDTH  
1400 MM (55 1/8 INCH)

GEWICHT / WEIGHT  
765 GR

PFLEGEANLEITUNG / CARE INSTRUCTIONS



VIDAR, BLACK 1880



VIDAR, CAMPARI 542



VIDAR, BAZOOKA 622

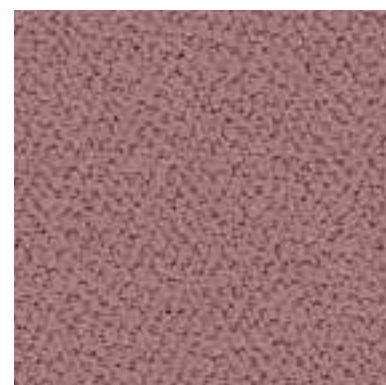

VIDAR, VINTAGE PINK 633

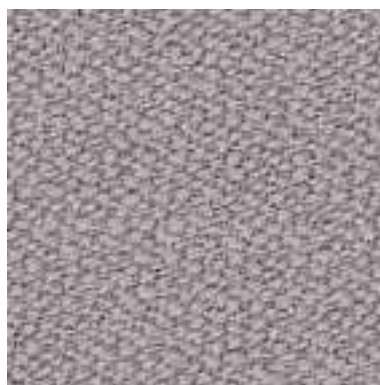

VIDAR, MUSHROOM 143

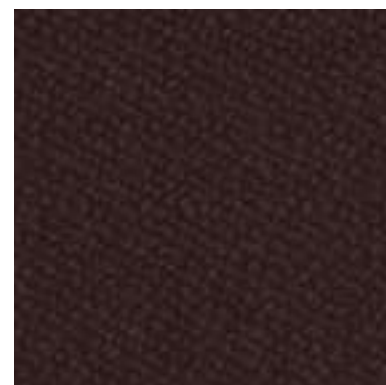

VIDAR, CASSIS 693

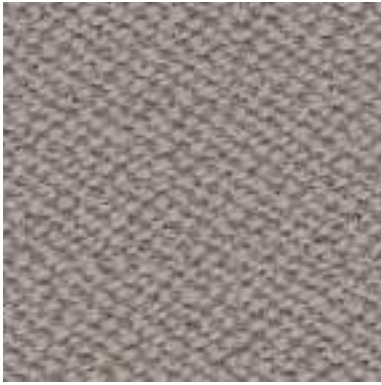

VIDAR, SAND 222

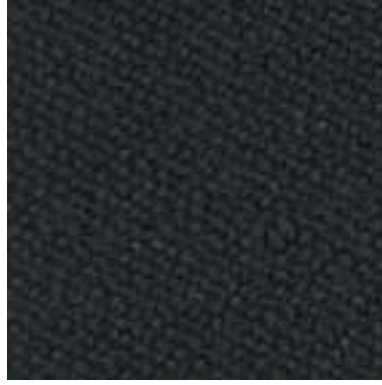

VIDAR, ESPRESSO 386



VIDAR, AMAZONA 932



VIDAR, OLIVE 972

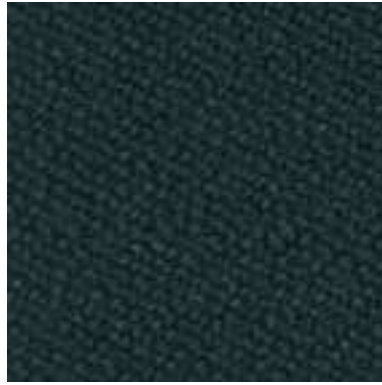

VIDAR, CYPRESS 1062



VIDAR, LEMON 443

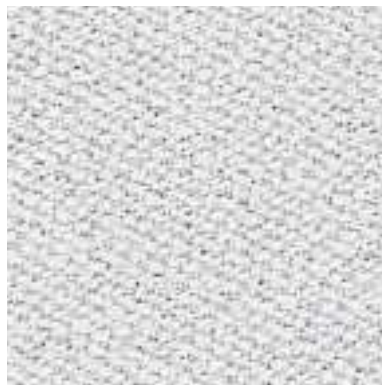

VIDAR, SILK GREY 123



VIDAR, OCEAN 733

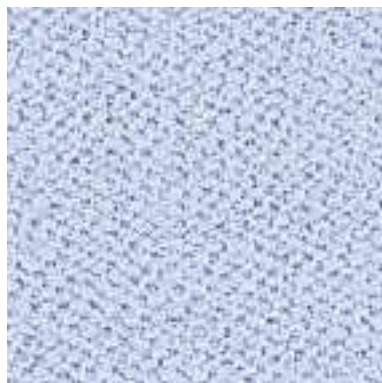

VIDAR, LAVENDER BLUE 723



MIDNIGHT 554

**STOFFE / FABRICS**

**TWILL WEAVE**

(STOFFGRUPPE D / FABRIC GROUP D)

QUALITÄT / CONTENT  
90% SCHURWOLLE, KAMMGARN /  
NEW WOOL WORSTED,  
10% NYLON / NYLON

SCHEUERFESTIGKEIT / RUB RESISTANCE  
60.000 MARTINDALE

LICHTECHTHEIT / FASTNESS TO LIGHT  
5-7 (ISO 1-8)

FLAMMSCHUTZ / FLAME RESISTANCE  
BS5852 PART 1 , BS 5852 CRIB 5 WITH TREATMENT

BREITE /WIDTH  
1400MM

GEWICHT PRO QM /WEIGHT PER SQM  
960 GR

PFLEGEANLEITUNG / CARE INSTRUCTIONS

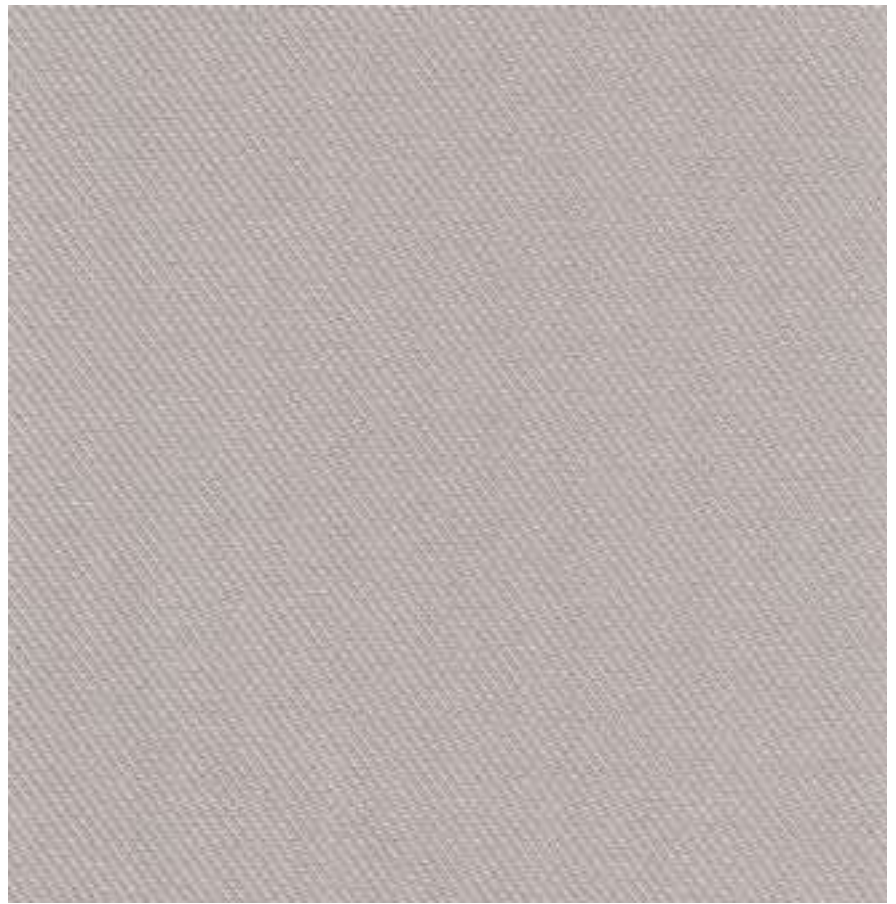

TWILL WEAVE, SILK GREY 110

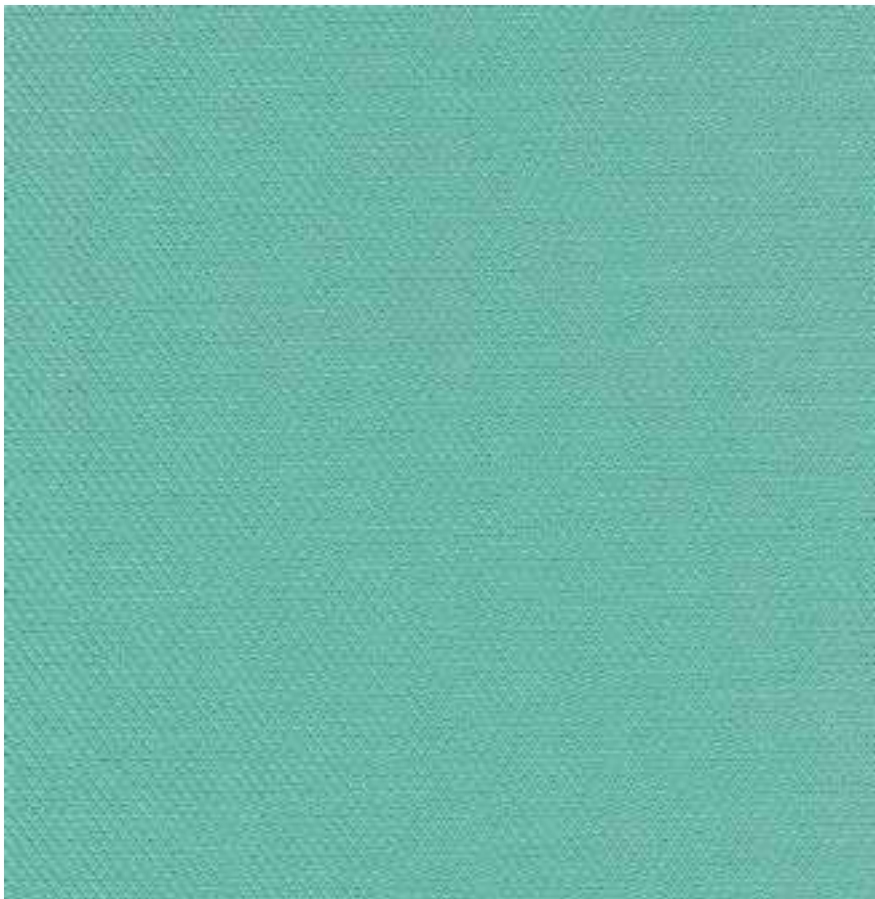

TWILL WEAVE, MINT 840



TWILL WEAVE, ANTHRACITE 790

**STOFFE / FABRICS**

**ATOM**

(STOFFGRUPPE E / FABRIC GROUP E)  
KVADRAT

**QUALITÄT / CONTENT**

90% SCHURWOLLE, KAMMGARN /  
NEW WOOL, WORSTED YARN,  
8% NYLON / NYLON,  
2% POLYESTER / POLYESTER

**SCHEUERFESTIGKEIT / RUB RESISTANCE**  
65.000 MARTINDALE

**LICHTECHTHEIT / FASTNESS TO LIGHT**  
TYP 7 (ISO 1-8)

**FLAMMSCHUTZ / FLAME RESISTANCE**  
EN 1021-1/2

**BREITE / WIDTH**  
1500 MM (59 INCH)

**GEWICHT PRO QM / WEIGHT PER SQM**  
706 GR

**PFLEGEANLEITUNG / CARE INSTRUCTIONS**

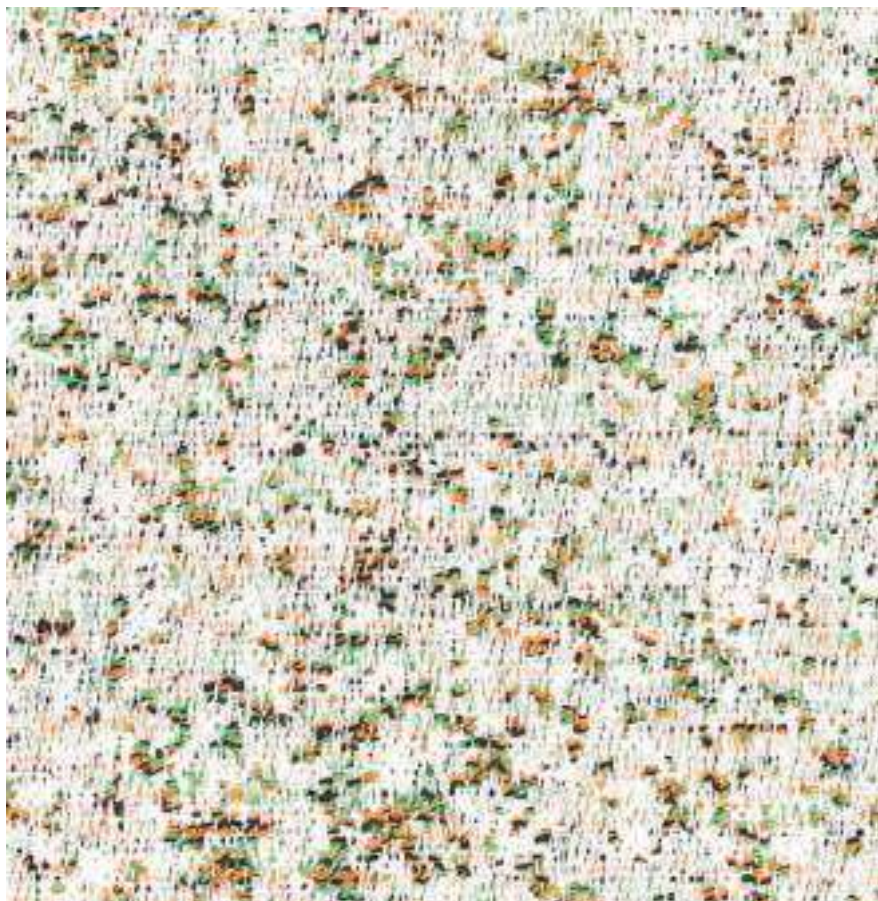

ATOM, IVORY 124

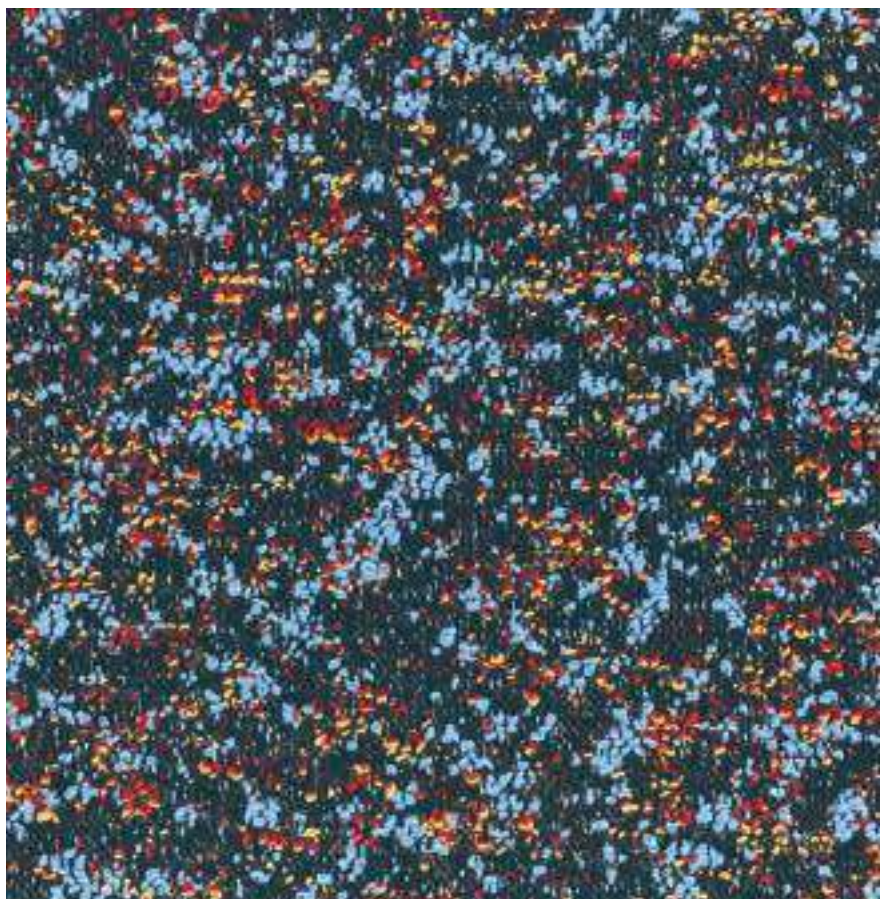

ATOM, BLACK FOREST 774

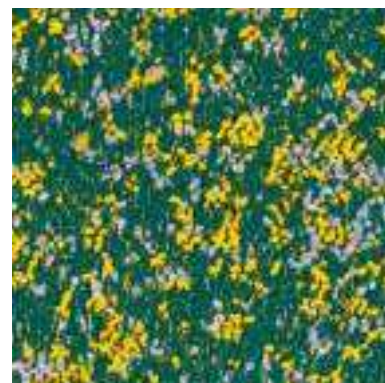

ATOM, FOREST 964



ATOM, BLACK 194

## STOFFE / FABRICS

### ZANZIBAR

(STOFFGRUPPE E / FABRIC GROUP E)

QUALITÄT / CONTENT  
100% MOHAIR / MOHAIR,  
BASIS: BAUMWOLLE / BASE: COTTON

SCHEUERFESTIGKEIT / RUB RESISTANCE  
100.000 WYZENBEECK

LICHTECHTHEIT / FASTNESS TO LIGHT  
HELLE FARBE / LIGHT COLOURS  
TYP 4-5,

DUNKLE FARBE / DARK COLOURS:  
TYP 5-6

FLAMMSCHUTZ / FLAME RESISTANCE  
EN 1021-1/2

BREITE / WIDTH  
1400 MM (55 INCH)

GEWICHT PRO QM / WEIGHT PER SQM  
805 GR

PFLEGEANLEITUNG / CARE INSTRUCTIONS

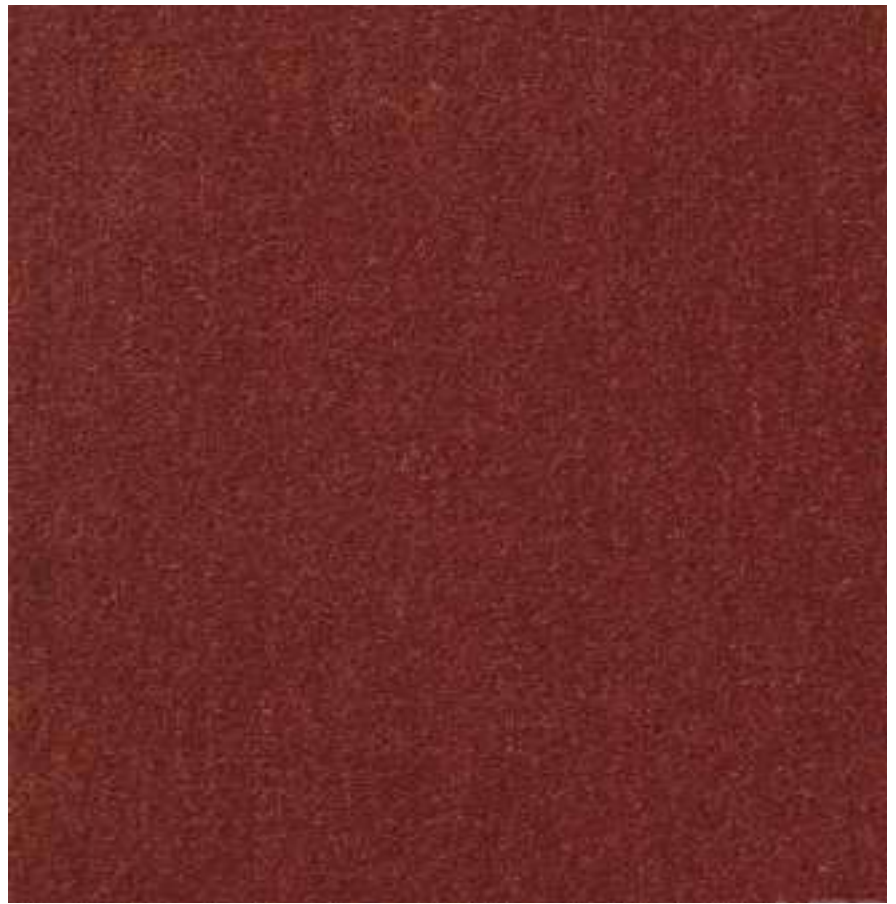

ZANZIBAR, CARNELIAN 18



ZANZIBAR, CYPRESS 25



ZANZIBAR, CARAMEL 01



ZANZIBAR, OLIVE 30



ZANZIBAR, SANDSTONE 11

## STOFFE / FABRICS

### BYRAM

(STOFFGRUPPE E / FABRIC GROUP E)  
KVADRAT

QUALITÄT / CONTENT  
100 % KID MOHAIR / KID MOHAIR

SCHEUERFESTIGKEIT / RUB RESISTANCE  
70.000 MARTINDALE

LICHTECHTHEIT / FASTNESS TO LIGHT  
TYP 7

FLAMMSCHUTZ / FLAME RESISTANCE  
EN 1021-1/2

BREITE / WIDTH  
1400 MM (55 INCH)

GEWICHT PRO QM / WEIGHT PER SQM  
890 GR

PFLEGEANLEITUNG / CARE INSTRUCTIONS

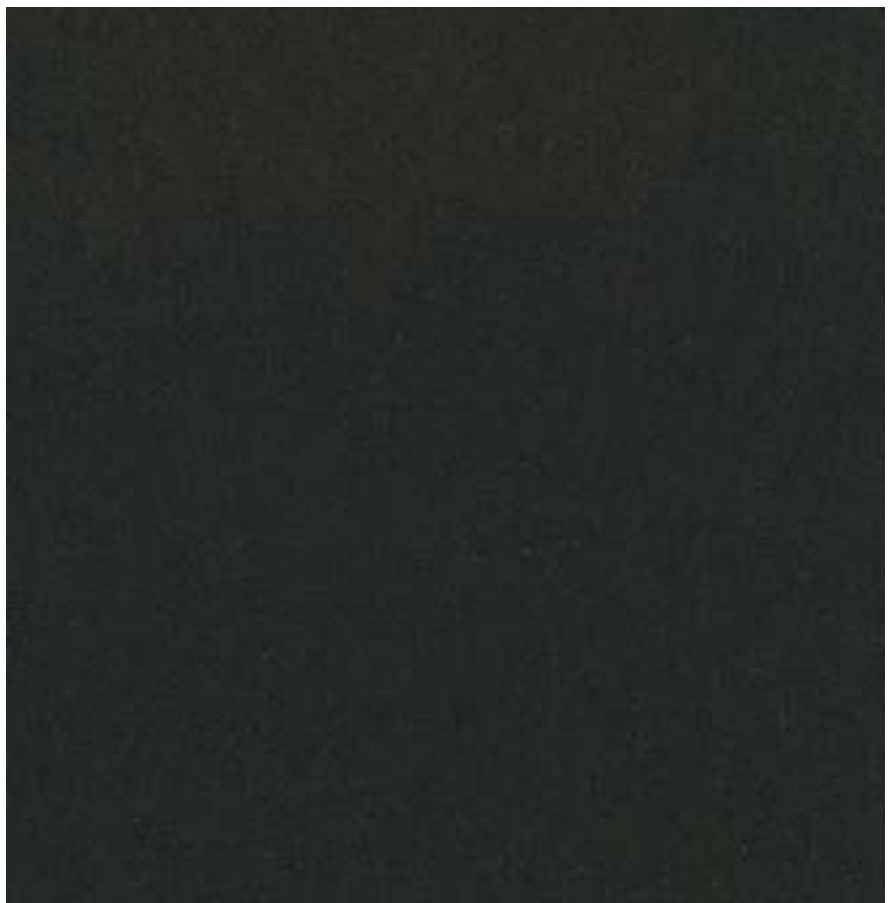

BYRAM, ESPRESSO 391



BYRAM, TAUPE 361



BYRAM, OCHRE 471

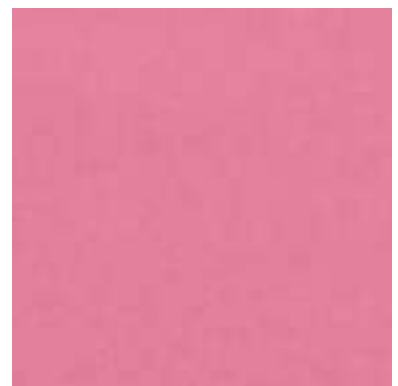

BYRAM, BAZOOKA 661



BYRAM, LAVENDER 651



BYRAM, POMEGRANATE 691



BYRAM, ROSE 621

## STOFFE / FABRICS

### KARAKORUM

(STOFFGRUPPE F / FABRIC GROUP F)  
DEDAR

#### QUALITÄT / CONTENT

42 % WOLLE / WOOL  
33 % VISKOSE / VISCOSE  
24 % BAUMWOLLE / COTTON  
1 % POLYAMID / POLYAMIDE

#### SCHEUERFESTIGKEIT / RUB RESISTANCE

40.000 MARTINDALE

#### BREITE / WIDTH

1300 MM (51 1/8 INCH)

#### GEWICHT PRO QM / WEIGHT PER SQM

1040 GR

#### PFLEGEANLEITUNG / CARE INSTRUCTIONS



KARAKORUM, CHARCOAL 006



KARAKORUM, ECUME 007

### PATCHWORK

(STOFFGRUPPE F / FABRIC GROUP F)  
DEDAR

#### QUALITÄT / CONTENT

60 % POLYESTER (TREVIRA) /  
POLYESTER (TREVIRA)  
40 % POLYESTER / POLYESTER

#### SCHEUERFESTIGKEIT / RUB RESISTANCE

50.000 MARTINDALE

#### BREITE / WIDTH

1380 MM (54 3/8 INCH)

#### GEWICHT PRO QM / WEIGHT PER SQM

760 GR

#### PFLEGEANLEITUNG / CARE INSTRUCTIONS



PATCHWORK, BLACK 006



## STOFFE / FABRICS

### SPLENDIDO

(STOFFGRUPPE F / FABRIC GROUP F)  
DEDAR

#### QUALITÄT / CONTENT

63 % VISKOSE / VISCOSE  
26 % BAUMWOLLE / COTTON  
11 % SEIDE / SILK  
(PILE:  
85 % BAUMWOLLE / COTTON  
15 % SEIDE / SILK)

#### SCHEUERFESTIGKEIT / RUB RESISTANCE

50.000 MARTINDALE

#### BREITE / WIDTH

1400 MM (55 1/8 INCH)

#### RAPPORT (H / B) / REPEAT (H / W)

845 / 690 MM (33 1/4 / 27 1/8 INCH)

#### GEWICHT PRO QM / WEIGHT PER SQM

1022 GR

#### PFLEGEANLEITUNG / CARE INSTRUCTIONS



SPLENDIDO, 003



SPLENDIDO, MALACHITE 031

## STOFFE / FABRICS

### TIGER MOUNTAIN

(STOFFGRUPPE F / FABRIC GROUP F)  
DEDAR

QUALITÄT / CONTENT  
63 % VISKOSE / VISCOSE  
37 % BAUMWOLLE / COTTON

SCHEUERFESTIGKEIT / RUB RESISTANCE  
40.000 MARTINDALE

BREITE / WIDTH  
1380 MM (54 3/8 INCH)

RAPPORT (H / B) / REPEAT (H / W)  
845 / 690 MM (33 1/4 / 27 1/8 INCH)

GEWICHT PRO QM / WEIGHT PER SQM  
720 GR

PFLEGEANLEITUNG / CARE INSTRUCTIONS



TIGER MOUNTAIN, GRAPHITE 001



TIGER MOUNTAIN, FAUVE 002

### TIGER BEAT

(STOFFGRUPPE F / FABRIC GROUP F)  
DEDAR

QUALITÄT / CONTENT  
52 % VISKOSE / VISCOSE  
35 % BAUMWOLLE / COTTON  
52 % POLYESTER / POLYESTER

SCHEUERFESTIGKEIT / RUB RESISTANCE  
30.000 MARTINDALE

1350 MM (53 1/8 INCH)

RAPPORT (H / B) / REPEAT (H / W)  
640 / 675 MM (25 1/4 / 26 5/8 INCH)

GEWICHT PRO QM / WEIGHT PER SQM  
764,5 GR

PFLEGEANLEITUNG / CARE INSTRUCTIONS



TIGER BEAT, FAUVE 001



TIGER BEAT, PAPAYA 004

## STOFFE / FABRICS

### ELECTRIC DREAMS

(STOFFGRUPPE G / FABRIC GROUP G)  
DEDAR

QUALITÄT / CONTENT  
64 % POLYESTER / POLYESTER  
23 % BAUMWOLLE / COTTON  
11 % ACETAT / ACETATE  
64 % METALLIC POLYESTER/  
METALLIC POLYESTER

SCHEUERFESTIGKEIT / RUB RESISTANCE  
10.000 MARTINDALE

BREITE / WIDTH  
1500 MM (59 INCH)

RAPPORT (H / B) / REPEAT (H / W)  
1100 / 1480 MM (43 1/4 / 58 1/4 INCH)

GEWICHT PRO QM / WEIGHT PER SQM  
418 GR

PFLEGEANLEITUNG / CARE INSTRUCTIONS



ELECTRIC DREAMS, MATIN BLEUTÉ 003

### SCARAMOUCHE

(STOFFGRUPPE G / FABRIC GROUP G)  
DEDAR

QUALITÄT / CONTENT  
77 % POLYESTER / POLYESTER  
18 % SEIDE / SILK  
5 % METALLIC POLYESTER /  
METALLIC POLYESTER

SCHEUERFESTIGKEIT / RUB RESISTANCE  
10.000 MARTINDALE

BREITE / WIDTH  
1450 MM (57 1/8 INCH)

RAPPORT (H / B) / REPEAT (H / W)  
990 / 720 MM (39 / 28 3/8 INCH)

GEWICHT PRO QM / WEIGHT PER SQM  
350 GR

PFLEGEANLEITUNG / CARE INSTRUCTIONS



SCARAMOUCHE,  
SUMMER FARANDOLE 001



SCARAMOUCHE, FROZEN WINTER 004

## STOFFE / FABRICS

### AMOR LIBRE

(STOFFGRUPPE E / FABRIC GROUP E)  
DEDAR

QUALITÄT / CONTENT  
65 % BAUMWOLLE / COTTON  
35 % VISKOSE / VISCOSE

SCHEUERFESTIGKEIT / RUB RESISTANCE  
12.000 MARTINDALE

BREITE / WIDTH  
1500 MM (59 INCH)

GEWICHT PRO QM / WEIGHT PER SQM  
360 GR

PFLEGEANLEITUNG / CARE INSTRUCTIONS



AMOR LIBRE, MALACHITE 031



AMOR LIBRE, CARDINALE 004



AMOR LIBRE, MALACHITE 031

## STOFFE / FABRICS

### KEIGA

(STOFFGRUPPE D / FABRIC GROUP D)  
SAHCO

QUALITÄT / CONTENT  
38 % SCHURWOLLE / NEWWOOL  
37 % VISKOSE / VISCOSE  
16 % LEINEN / LINEN  
9 % NYLON / NYLON

SCHEUERFESTIGKEIT / RUB RESISTANCE  
50.000 MARTINDALE

BREITE / WIDTH  
1400 MM (55 1/8 INCH)

GEWICHT PRO QM / WEIGHT PER SQM  
740 GR

PFLEGEANLEITUNG / CARE INSTRUCTIONS

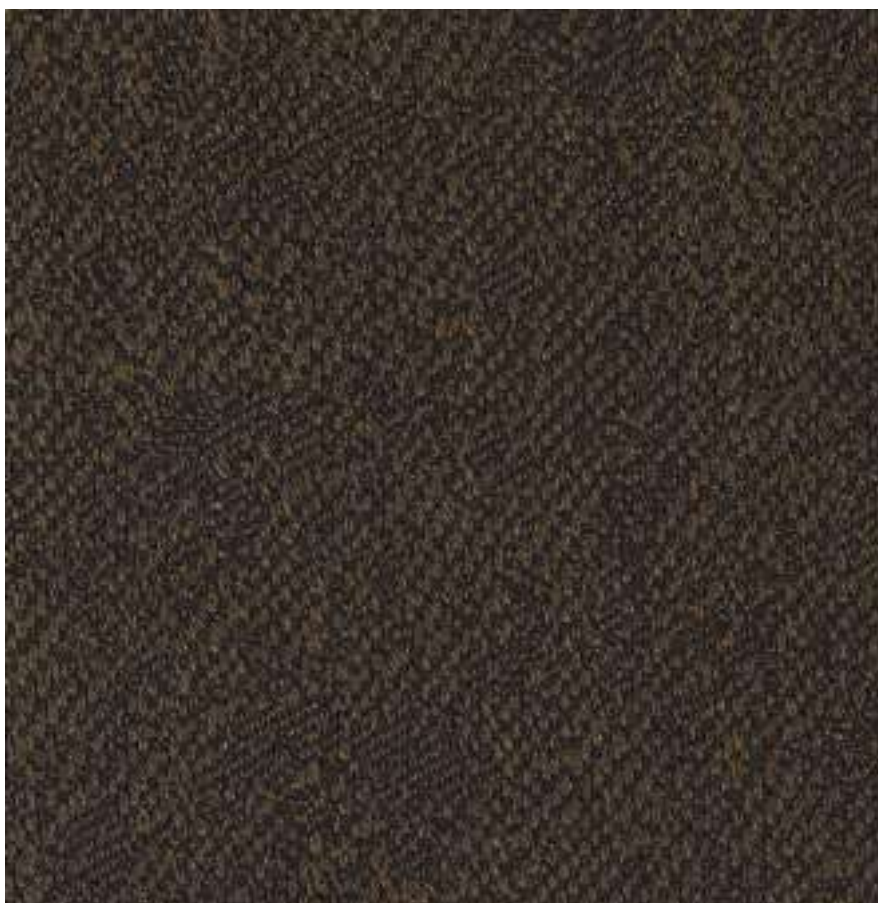

KEIGA, COFFEE 032

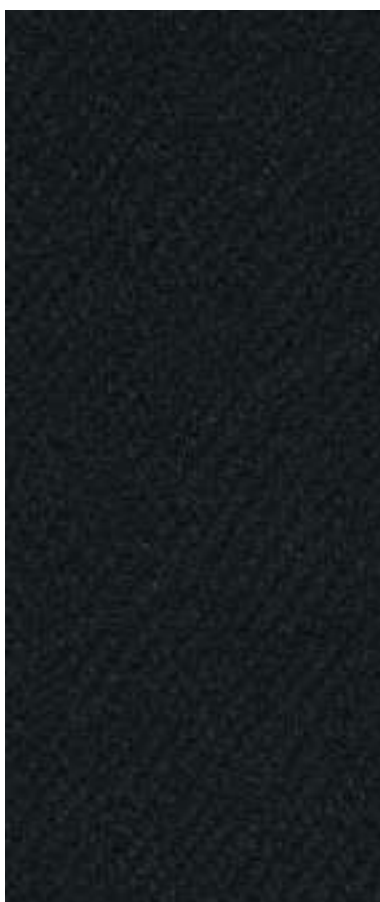

KEIGA, BLACK 0192



KEIGA, IVORY 0222

**STOFFE / FABRICS**

**TABLU**

(STOFFGRUPPE F / FABRIC GROUP F)  
SAHCO

QUALITÄT / CONTENT  
67 % SCHURWOLLE / NEWWOOL  
12 % VISKOSE / VISCOSE  
12 % LEINEN / LINEN  
6 % POLYESTER / POLYESTER  
3 % NYLON / NYLON

SCHEUERFESTIGKEIT / RUB RESISTANCE  
50.000 MARTINDALE

BREITE / WIDTH  
1400 MM (55 1/8 INCH)

GEWICHT PRO QM / WEIGHT PER SQM  
1080 GR

PFLEGEANLEITUNG / CARE INSTRUCTIONS



TABLU, BEIGE 0232



TABLU, GREY 0182



TABLU, BLACK/WHITE 0152



TABLU, BLACK/WHITE 0142



TABLU, CHOCOLATE 0392



TABLU, POPPY 0572

**STOFFE / FABRICS**

**SATORA**  
(STOFFGRUPPE E / FABRIC GROUP E)  
SAHCO

QUALITÄT / CONTENT  
76 % RECYCELTES POLYESTER FR /  
RECYCLED POLYESTER FR  
24 % NYLON / NYLON

SCHEUERFESTIGKEIT / RUB RESISTANCE  
25.000 MARTINDALE

BREITE / WIDTH  
1400 MM (55 1/8 INCH)

GEWICHT PRO QM / WEIGHT PER SQM  
430 GR

PFLEGEANLEITUNG / CARE INSTRUCTIONS

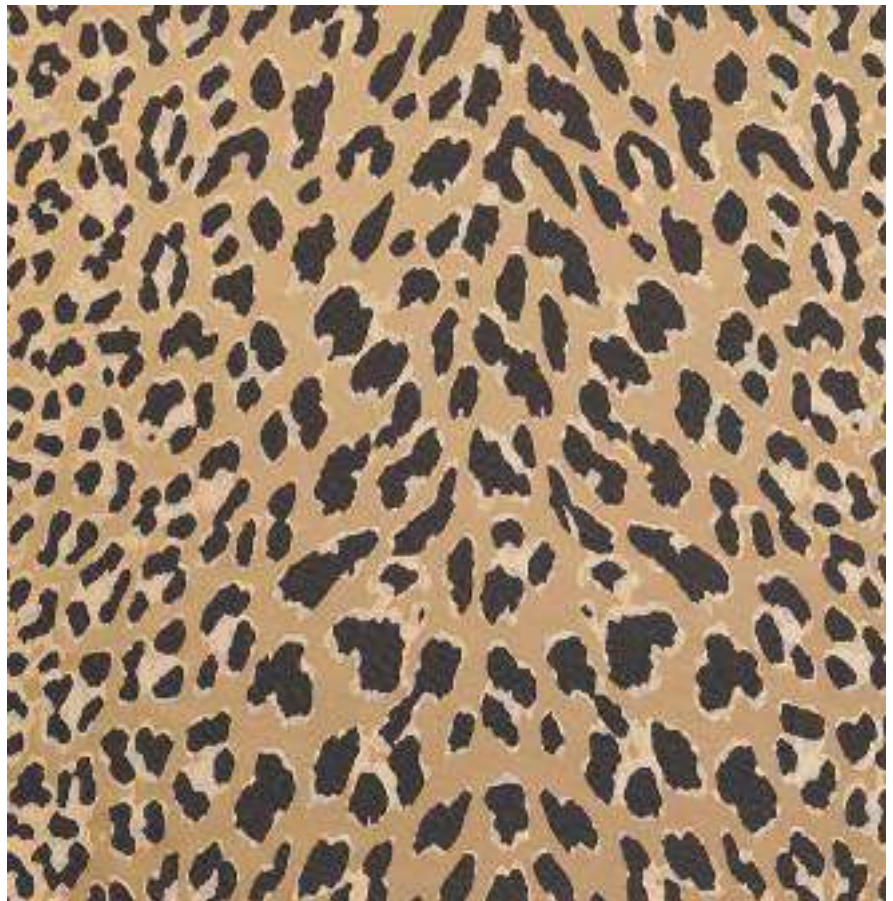

SATORA, GOLD 0342

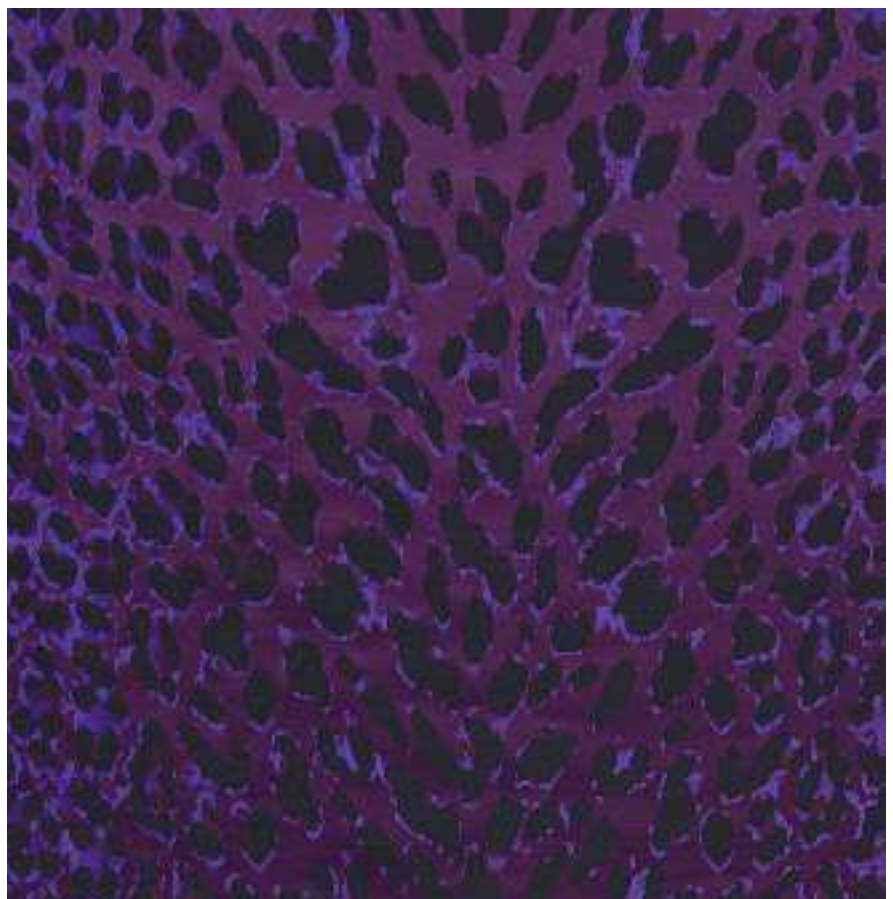

SATORA, VIOLET 0682

## STOFFE / FABRICS

### BASEL

(STOFFGRUPPE E / FABRIC GROUP E)  
KVADRAT

QUALITÄT / CONTENT  
90 % SCHURWOLLE / NEWWOOL  
10 % NYLON / NYLON

SCHEUERFESTIGKEIT / RUB RESISTANCE  
50.000 MARTINDALE

BREITE / WIDTH  
1400 MM (55 1/8 INCH)

GEWICHT PRO QM / WEIGHT PER SQM  
510 GR

PFLEGEANLEITUNG / CARE INSTRUCTIONS

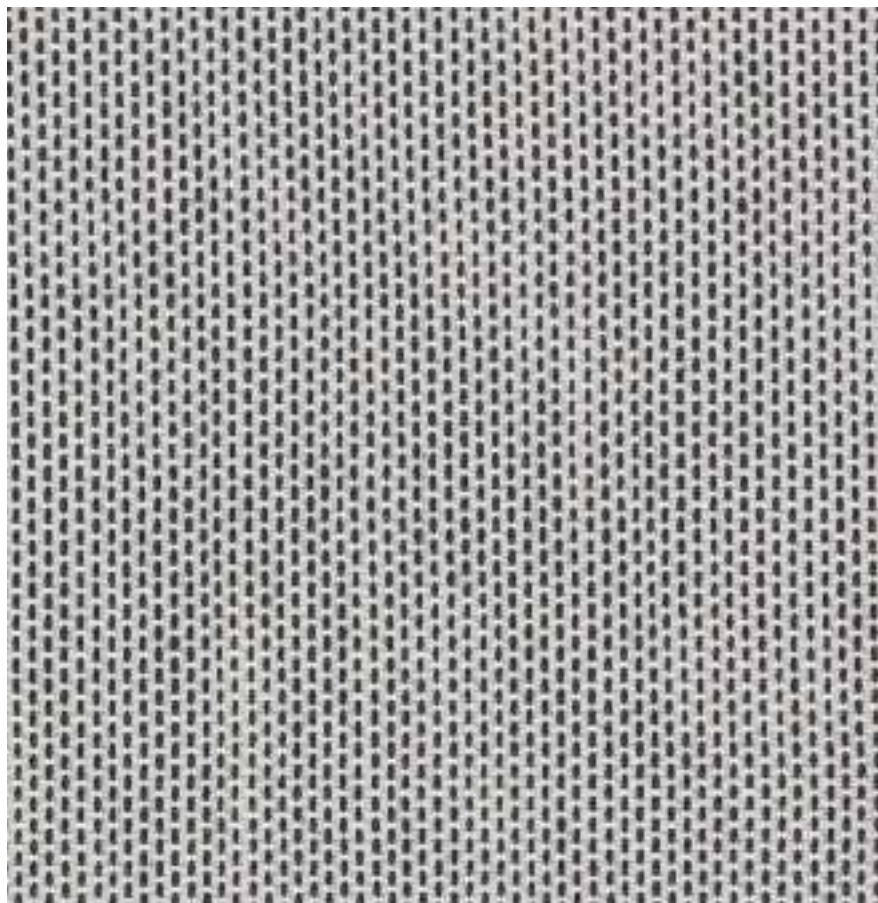

BASEL, IVORY 129



BASEL, BLACK 189



## STOFFE / FABRICS

### HAVANA

(STOFFGRUPPE D / FABRIC GROUP D)  
LIBECO

QUALITÄT / CONTENT  
55 % LEINEN / LINEN  
35 % WOLLE / WOOL  
10 % NYLON / NYLON

SCHEUERFESTIGKEIT / RUB RESISTANCE  
100.000 MARTINDALE

BREITE / WIDTH  
1400 MM (55 1/8 INCH)

GEWICHT PRO QM / WEIGHT PER SQM  
1000 GR

PFLEGEANLEITUNG / CARE INSTRUCTIONS



HAVANA, GREEN 5261



HAVANA, MUD 5260

**LEDER / LEATHER**

**LEDER SELECT (STOFFGRUPPE E / FABRIC GROUP E)**

RINDSLEDER, SEMI-ANILIN, PIGMENTIERT, GEPRÄGT, 1,2-1,4 MM / COW HIDE, SEMI ANILINE, PIGMENTED, EMBOSSED, 1.2-1.4 MM



SELECT, PERKAMENT 318



SELECT, STERLING 310



SELECT, SMOKE 231



SELECT, WALNUT 234



SELECT, ESPRESSO 306

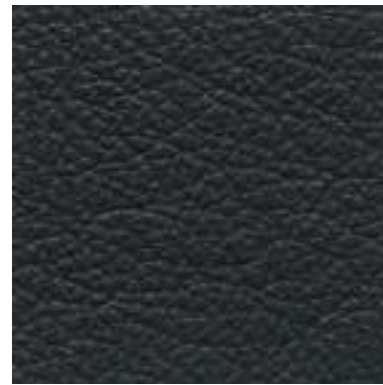

SELECT, BLACK 301

**LEDER RANCHERO (STOFFGRUPPE F / FABRIC GROUP F)**

RINDSLEDER, REIN ANILIN, ANILIN GEFÄRBT, 0,9-1,4 MM / COW HIDE, PURE ANILINE, ANILINE DYED, 0.9-1.4 MM



RANCHERO, NUSS / WALNUT



RANCHERO, BRAUN / BROWN



RANCHERO, SCHWARZ / BLACK

**LEDER / LEATHER**

**LEDER HARNESS**

RINDSLEDER SCHULTER, ANILIN (NATUR) BIS SEMI-ANILIN, 2–2,5 MM / COW HIDE, SHOULDER, ANILINE (NATURAL) TO SEMI-ANILINE, 2–2,5 MM



GURTLER NATUR /  
HARNESS LEATHER NATURAL



GURTLER BRANDY /  
HARNESS LEATHER BRANDY



GURTLER SCHWARZ /  
HARNESS LEATHER BLACK

**LEDER ‚PROTECTED‘ / LEATHER ‚PROTECTED‘**  
WASSERABWEISEND / WATER-RESISTANT



PROTECTED, ECRU 4252



PROTECTED, ELEPHANT 42511

Darstellung nicht farbverbindlich / Actual colour may vary slightly