



KOLLECTABALL™

# KOLLECTABALL K-COURT & K-FIELD

## ASSEMBLY INSTRUCTIONS

### IMPORTANT

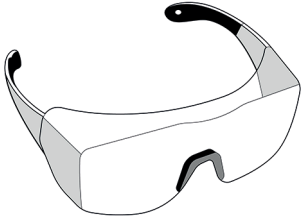

**Protective eyewear must be worn during assembly.**

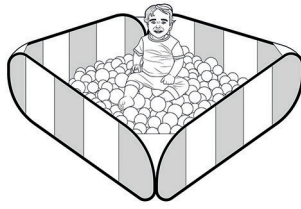

**For Pickleball and Playpen Balls you need 30 wire cage. See page 8 for assembly instructions.**



5 060885 290236

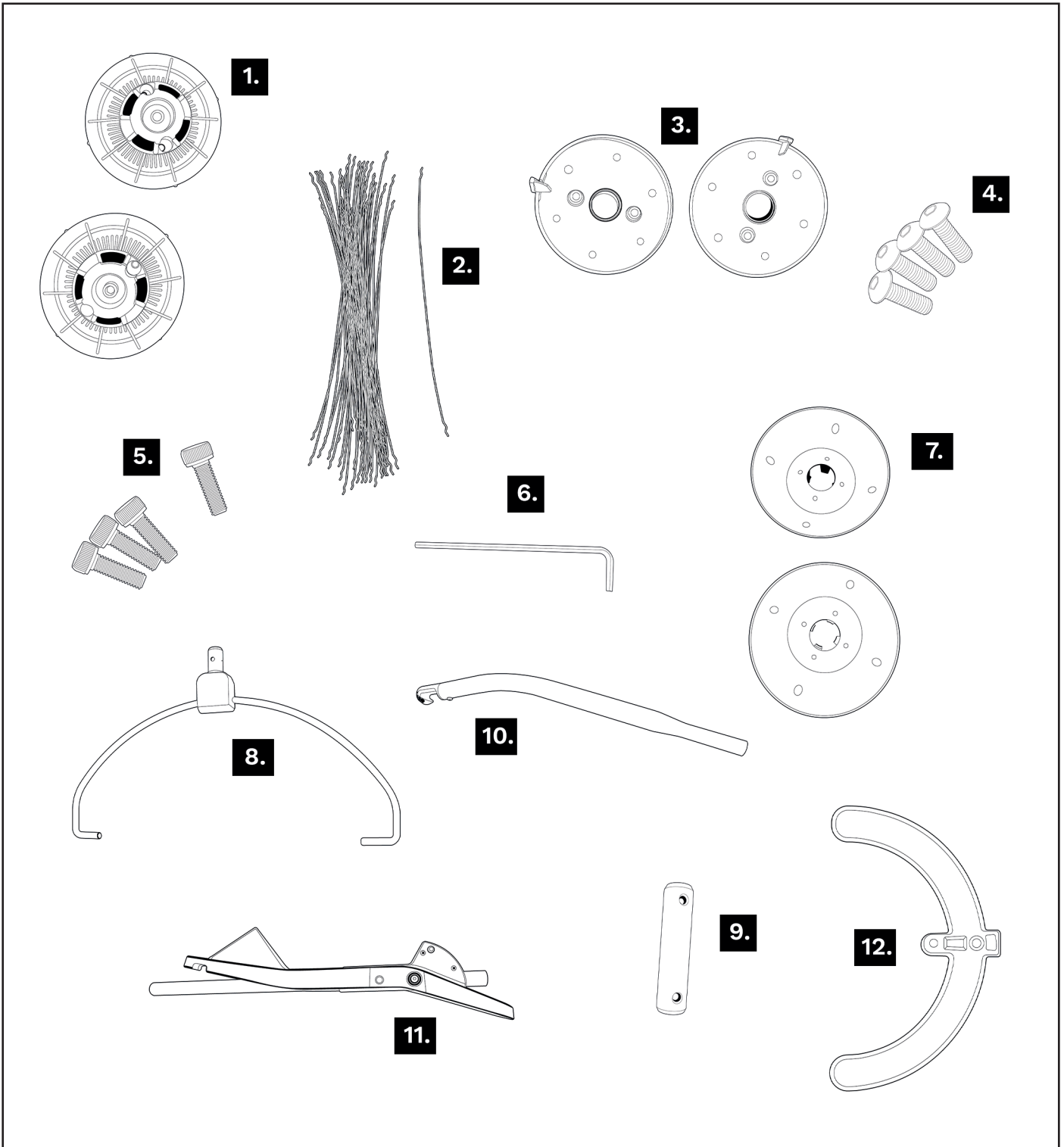

**Empty all of the box contents onto a flat surface and count parts to make sure all are there.**

- |   |                                 |
|---|---------------------------------|
| <b>1.</b> Wire Mounting Assembly          | <b>8.</b> Cage Mounting Bracket |
| <b>2.</b> Wires x 61                      | <b>9.</b> Handle Coupler        |
| <b>3.</b> Wire Mounting Assembly End Caps | <b>10.</b> Upper Handle         |
| <b>4.</b> 4x M6 Screws                    | <b>11.</b> Lower Handle         |
| <b>5.</b> 4x M4 Screws                    | <b>12.</b> U Stand              |
| <b>6.</b> Allen Key                       |                                 |
| <b>7.</b> Inner Cones                     |                                 |

# WIRE QUANTITY GUIDELINES FOR PRODUCT ASSEMBLY KOLLECTABALL

KOLLECTABALL COURT	WIRE NUMBERS
Tennis (all surfaces, all ball types)	60
Pickleball Outdoors	60 or 30
Pickleball indoors	30
Pedal	60
Playpen balls	30
KOLLECTABALL FIELD	
Baseball	60
Tennis	60
Cricket	60
Hockey	60
Apple collection	60
All larger windfall fruits	60
KOLLECTABALL GOLF PRO	
Golf balls	60
Small windfall fruit and larger nuts	60
KOLLECTABALL MINI	
Golf balls	30
Squash Balls	30
Small nuts	60
Table tennis balls	30

### **GUARANTEE**

All Kollektaball products are guaranteed for a period of 1 year from customer purchase. The Kollektaball guarantee covers manufacturing defect and any breakages due to manufacturing fault. Breakage due to misuse, willful or accidental are not covered by the guarantee. Kollektaball wires are a consumable item and are not covered by the guarantee.

### **BEST PRACTICE FOR EFFECTIVE BALL COLLECTION**

For maximum effectiveness of collection, the Kollektaball should be swept over the surface in a brisk backwards and forward's motion. The cage will collect objects whether pulled backwards or forwards over them. There is no requirement to push downwards on the handle. Pushing the cage into the ground is unnecessary and will reduce wire life. Simply push the Kollektaball over objects to be collected keeping the handle at between 40 and 45 degrees to the ground.

ASSEMBLY STEPS

KOLLECTABALL

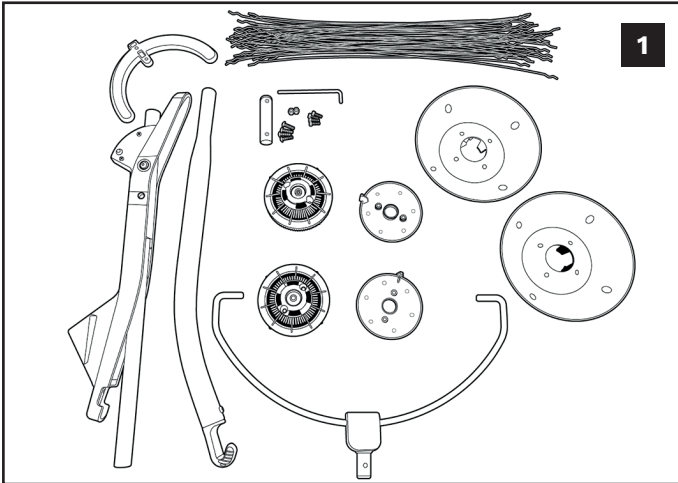

Check you have all the materials needed by cross referencing the parts against the image on the first page.

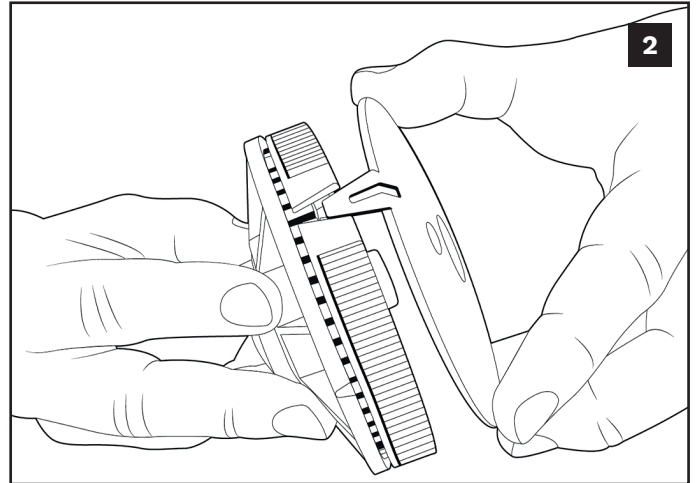

As shown on the picture split end caps from wire mounting assembly.

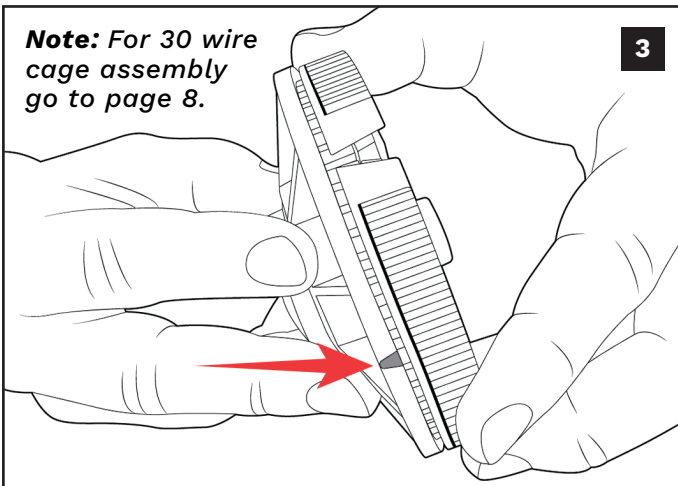

**Note:** For 30 wire cage assembly go to page 8.

Take part number 1 (Wire Mounting Assembly). There are four triangle shaped marks on the side. Locate all four. Your first four wires will insert under these marks.

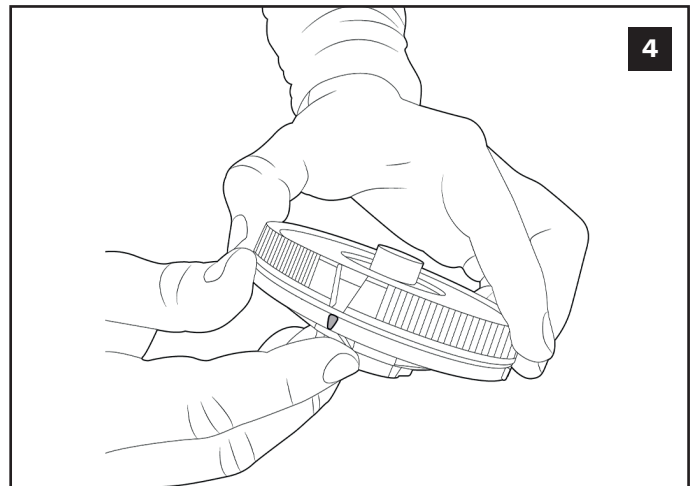

You will find the bottom of the disk turns separately from the top. To insert a wire into the disk, line up the V on the top of the disk with the opening on the bottom disk.

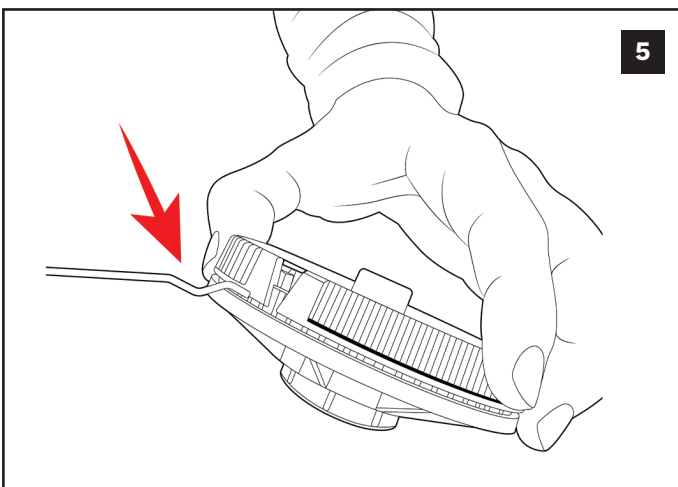

The wires should be loaded in the direction shown. To lock the wire in place, move the top of the disk across to the next marked location.

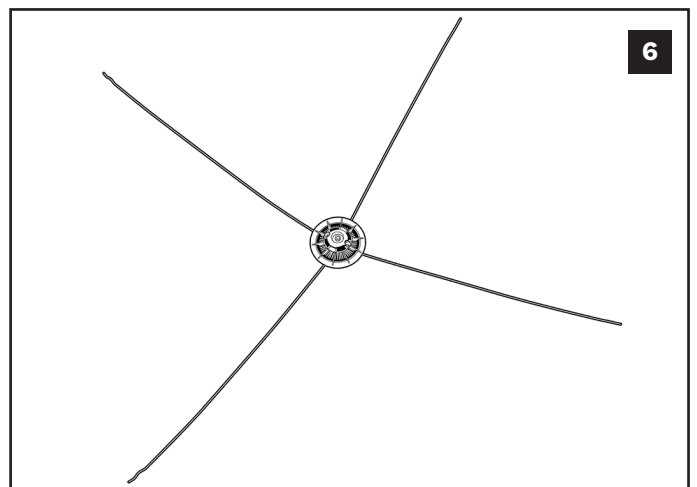

Repeat step 5, 3 more times until all 4 wires are inserted. Your Kollectaball should now look like this.

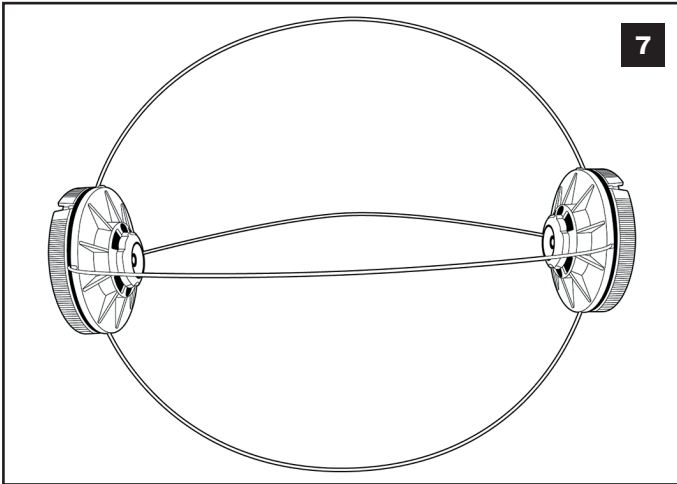

Take the other wire mounting assembly and insert the other ends of the wires at the four corresponding triangular marks. Your Kollektaball should now look like this.

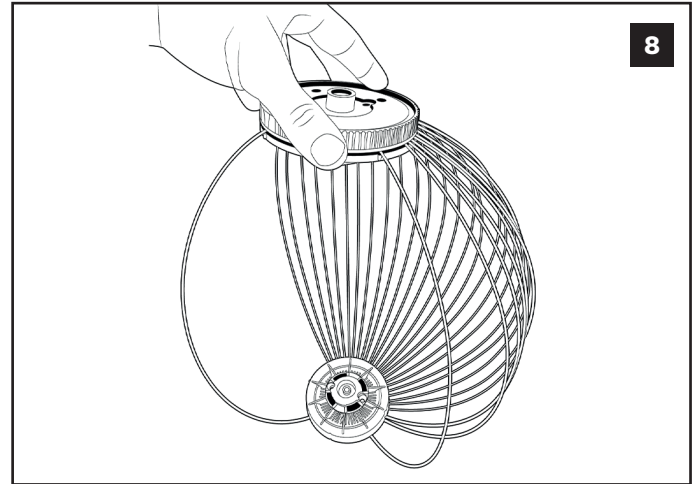

Take the remaining wires and insert them. Continue inserting wires in every hole.

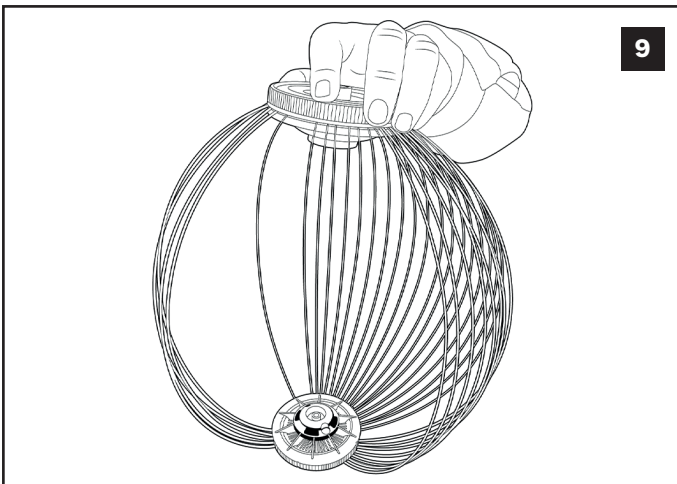

After inserting several wires on one side, it is advised to repeat the process on the other side of the cage. This will even up the weight distribution and make insertion easier.

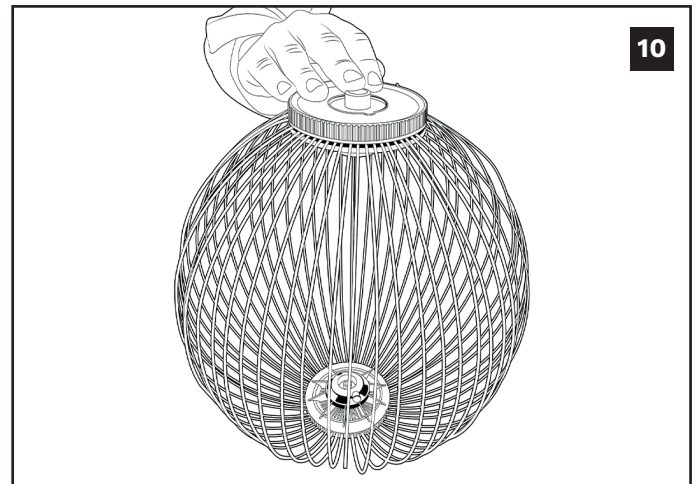

Continue inserting wires until the cage is complete. **NOTE:** If a wire is inserted incorrectly in a wrong hole, rotate the top section of the wire mounting assembly so the V opening lines up with the mistakenly inserted wire and pull the wire out.

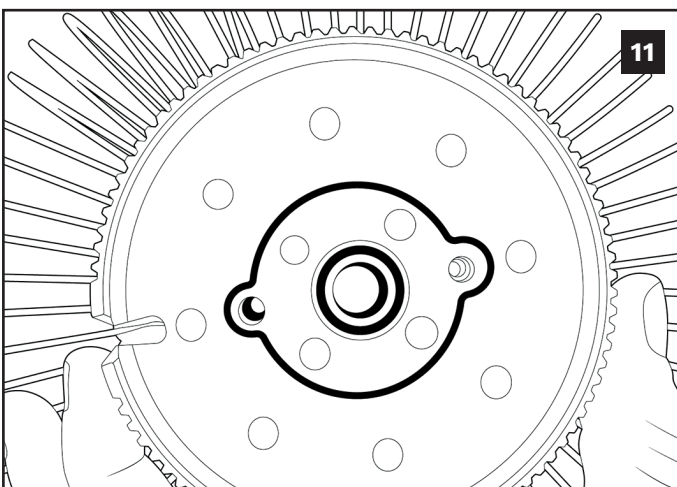

Rotate the disk until the holes on the top of the wire mounting assembly line up with the gold coloured threaded inserts in the inner section of the wire mounting assembly.

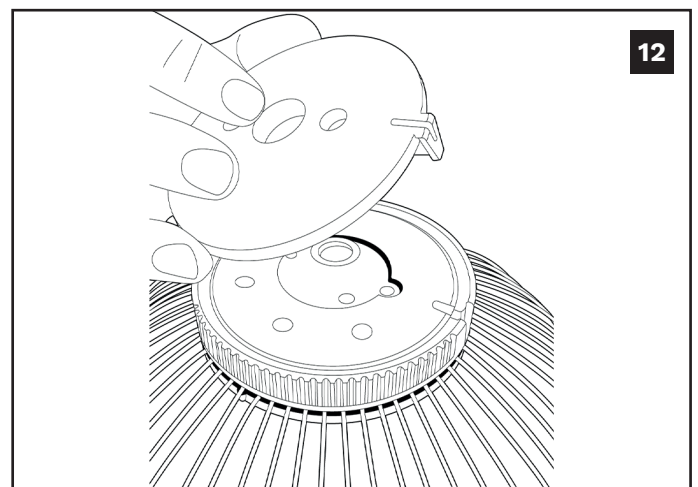

Take the end cap and line it up as shown in the picture. It should seat in place.

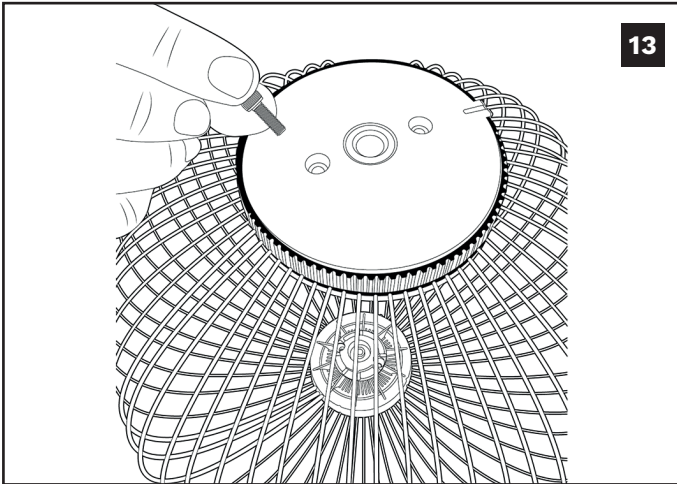

Insert the 2 x M4 screws into the two holes and tighten with allen key provided.

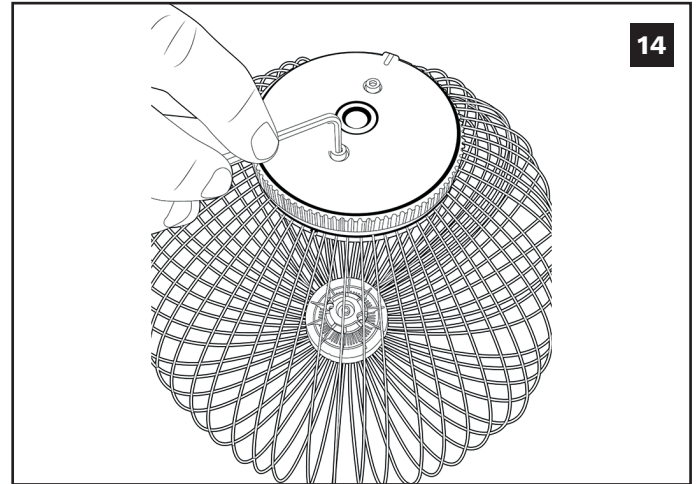

Repeat the same process on the opposite side.

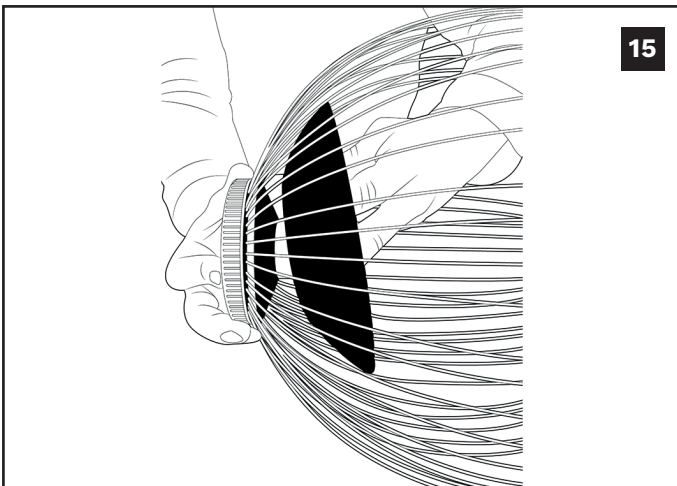

Take a green inner cone and slide it into the cage. Line up the four inner prongs against the four spaces on the inside of the wire mounting assembly and push the cone onto the disk as shown. They will click into place.

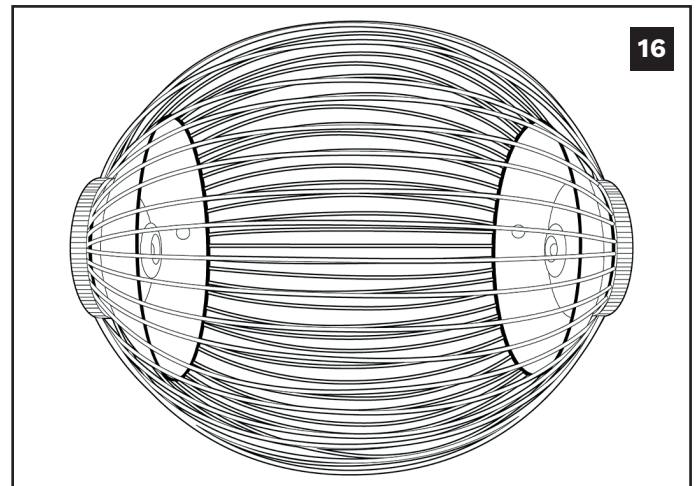

Repeat the same process on the other side. Your Kollektaball should now look like this. Your Kollektaball cage is complete.

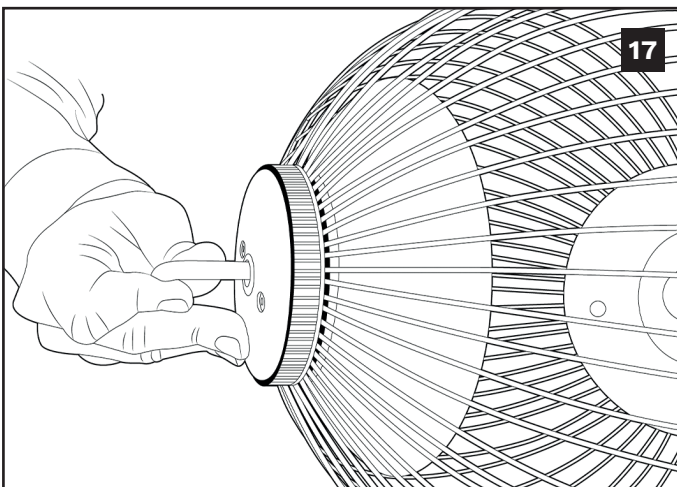

Take the cage mounting bracket and line up the prongs at the bottom with holes in the end caps as shown. To aid in achieving this squeeze the ends of the cage together

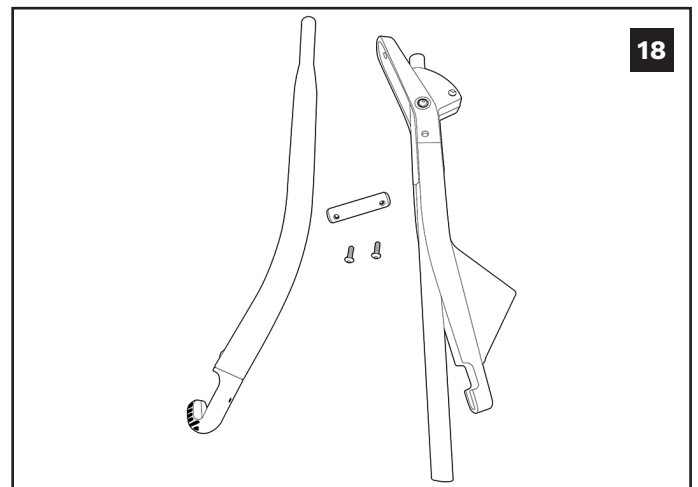

Locate the upper handle, lower handle, handle coupler and 2 x M6 Screws.

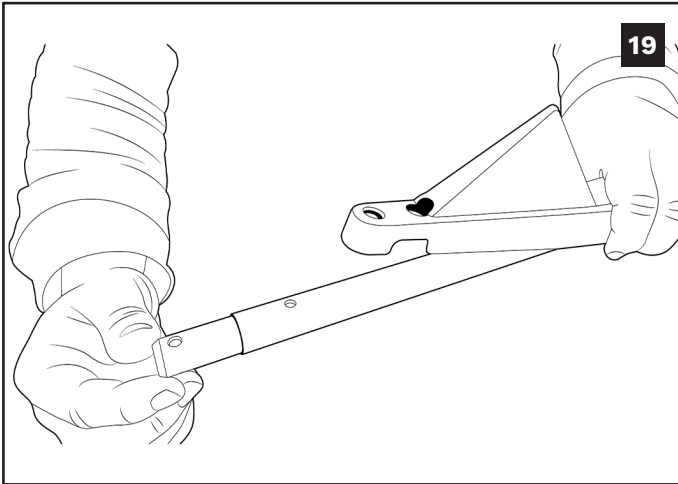

Locate the top of the lower handle (the side closest to the V shaped opener) and insert the coupler. Line up the holes, insert and tighten the M6 screw with allen key.

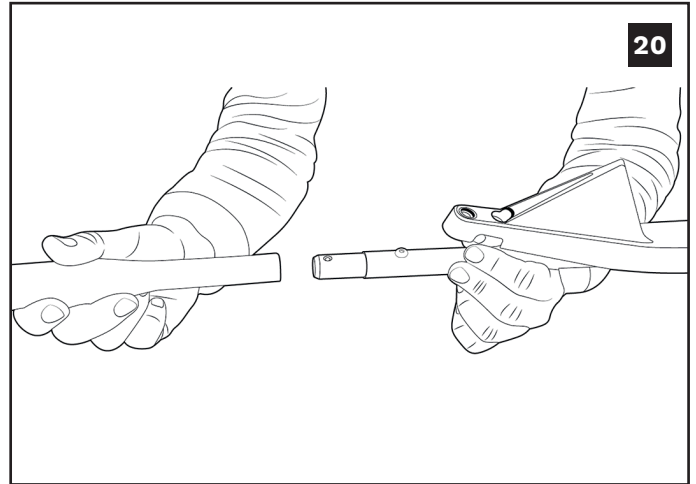

Take the upper handle and connect into the lower handle. Line up the holes and use the allen key to tighten the M6 screw in place.

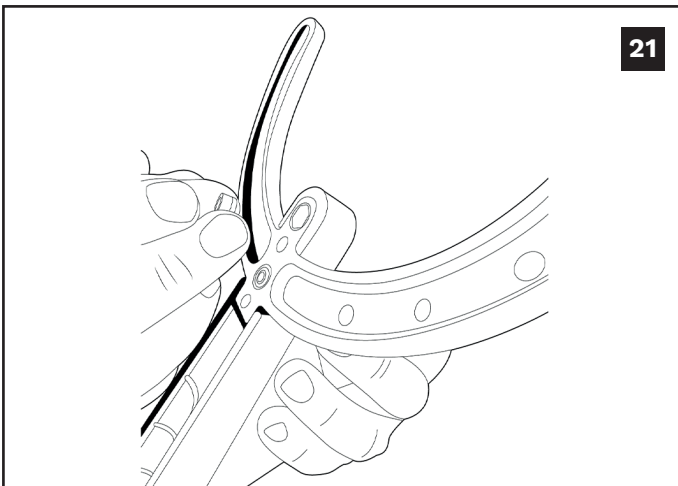

Take the U stand and line it up with the holes on the bottom of the V shaped opener.

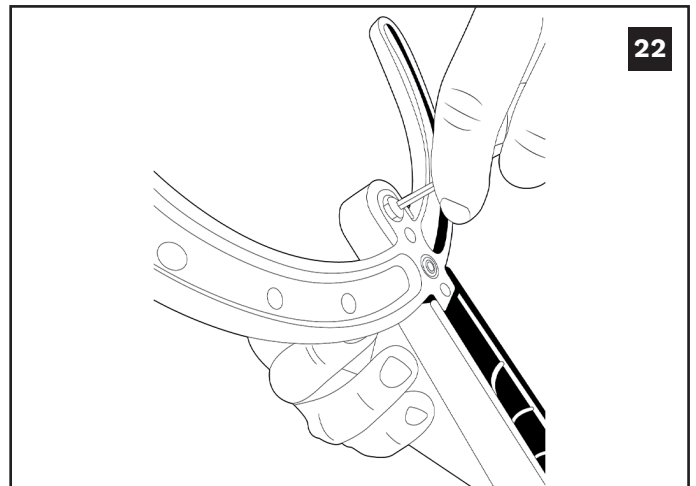

Take the two remaining M6 screws and tighten the U stand to the V- opener, using the allen key.



Take the handle and attach it to the cage mounting bracket. The spring loaded button clip locates into the hole in the lower handle.

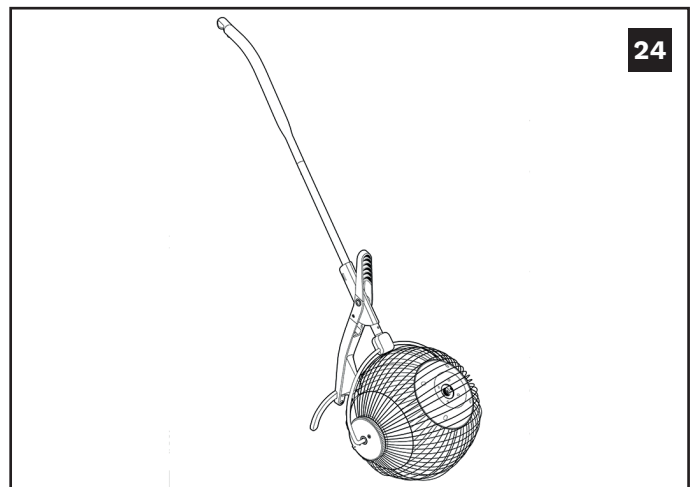

Your Kollectaball is now complete.

ASSEMBLY STEPS

KOLLECTABALL

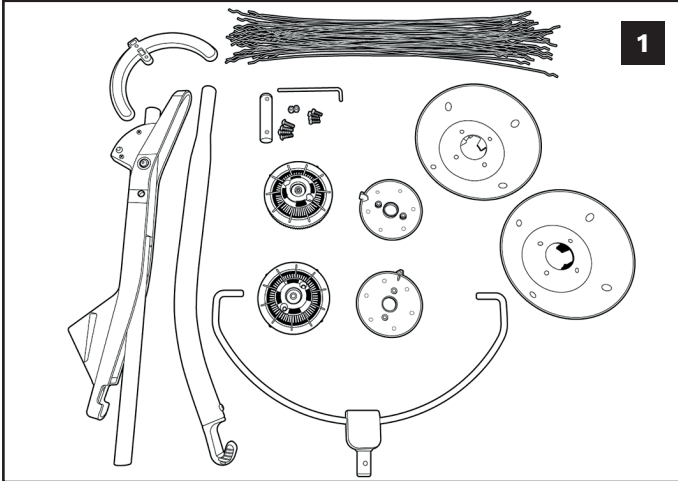

Check you have all the materials needed by cross referencing the parts against the image on the first page.

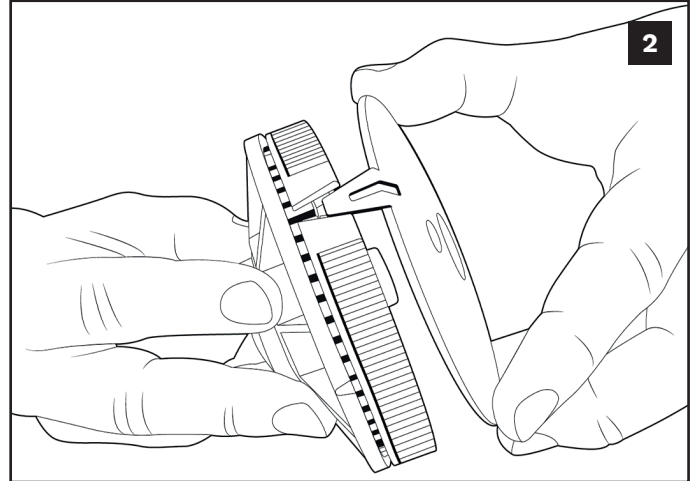

As shown on the picture split end caps from wire mounting assembly.

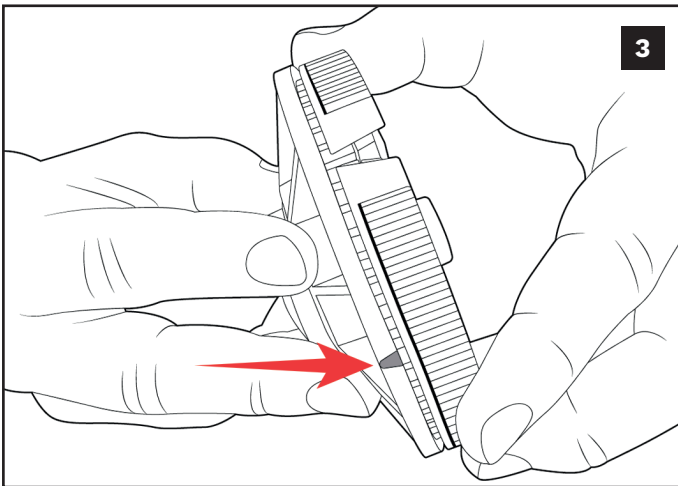

Take part number 1 (Wire Mounting Assembly). Observe the four triangle-shaped marks on the side. Insert your first two wires under the marks on opposite sides.

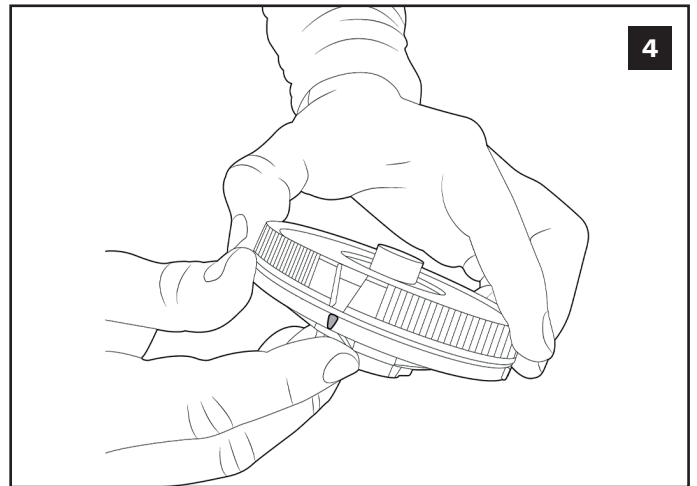

You will find the bottom of the disk turns separately from the top. To insert a wire into the disk, line up the V on the top of the disk with the opening on the bottom disk.

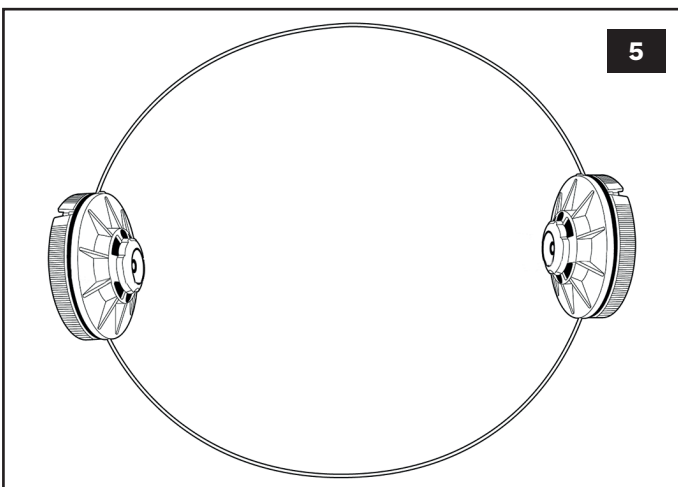

Take the other wire mounting assembly and insert the other ends of the wires at the two corresponding triangular marks. Your Kollektaball should now look like this.

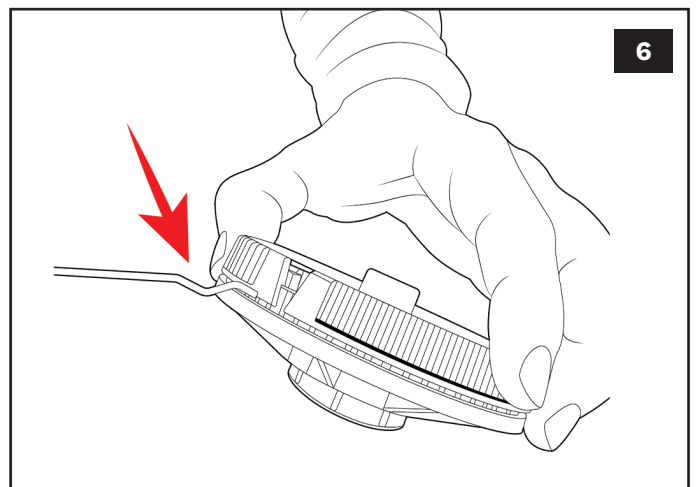

The wires should be inserted in the direction shown. Insert a wire in alternate holes working around the circular disk until all 30 wires are loaded in one wire mounting assembly. Load the wires in the second wire mounting assembly in the same way to complete the cage.



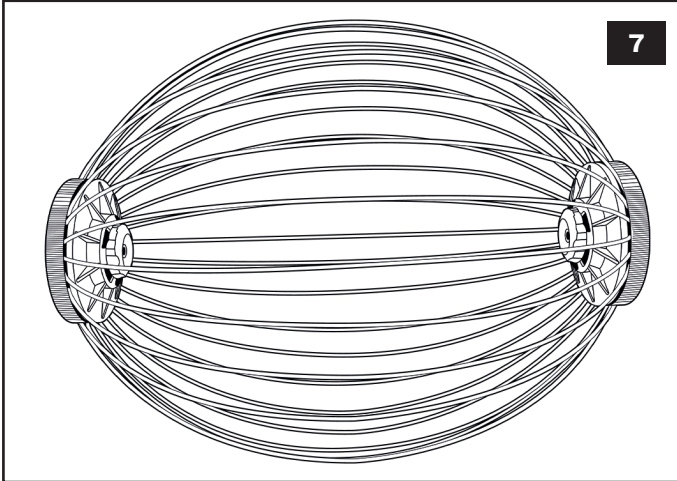

Your cage should now look like this. Now go back to step 10 in the 60 wire assembly section.