

GAMMA®

7900 Els STRINGING MACHINE 6 PT QM MOUNTING



OWNER'S MANUAL
Issue 1 - June 2015

GAMMA.

7900 Els OWNER'S MANUAL

TABLE OF CONTENTS

WARRANTY.....	PAGE 2
FEATURES	PAGE 3
UNPACKING & ASSEMBLY INSTRUCTIONS.....	PAGE 4
POWER CONNECTION & CONTROLS.....	PAGE 11
CONTROL PANEL FUNCTIONS AND FEATURES.....	PAGE 12
STRING GRIPPER OPERATION.....	PAGE 13
MOUNTING THE FRAME.....	PAGE 14
STRINGING THE FRAME	PAGE 15
STRING LENGTH METER	PAGE 19
ADDITIONAL FEATURES.....	PAGE 20
PATHFINDER AWL.....	PAGE 21
MAINTENANCE & ADJUSTMENTS.....	PAGE 22
TROUBLESHOOTING TIPS.....	PAGE 24
PARTS LIST.....	PAGE 26
PARTS DRAWING	PAGE 27

LIMITED WARRANTY

GAMMA SPORTS warrants to the original purchaser that the 7900 Els stringing machine ("EQUIPMENT") purchased is free from defects in materials and workmanship for a period of five (5) years from the date of original purchase for mechanical parts (excluding electrical parts and string clamps), and for a period of one (1) year from the date of purchase for all electrical parts and string clamps. Should any defects develop under normal use within the specified time periods, GAMMA will at its option, repair or replace the defective EQUIPMENT provided it is returned to GAMMA prepaid at the purchaser's expense. This warranty does not apply to any damage or defect caused by negligence, abuse, misuse, unauthorized alteration, shipping, handling, or part wear and tear as a result of normal use.

Routine maintenance, adjustment, and cleaning required to ensure proper operation are the responsibility of the purchaser and are not covered under the terms of this warranty. These include, but are not limited to: String Clamp adjustment, as described on page 23, Clamp Base adjustment, as described on page 23, and the cleaning procedures listed on page 24.

GAMMA's obligation under this warranty is limited to repair or replacement of defective EQUIPMENT, and no one is authorized to promise any other liability. GAMMA shall in no event be liable for any incidental or consequential damages.

To return defective EQUIPMENT, a return authorization (RA#) must be obtained from a GAMMA customer service representative. The RA# must be marked on the outside of the shipping carton being returned. All returns must be shipped prepaid by the customer to GAMMA. Please retain the original shipping carton and packing materials for any future shipments. GAMMA will not be responsible for machines which are not sent in the original undamaged packaging.

A GAMMA Care Service Plan is also available through GAMMA customer service, call 800.333.0337 for details.

MACHINE FEATURES



MACHINE FEATURES

- ❖ Electric Constant Pull Tensioner with 11.0 to 90.0 lbs Tension Range
- ❖ Digital Tension Setting with LED Display
- ❖ Quick Closing Linear String Gripper
- ❖ Professional Six Point “*Quick Mount*” Racquet Mounting System- Accommodates All Racquets
- ❖ Professional “*Quick Action*” Dual Action, Rotating base clamps
- ❖ 4 Tooth Universal String Clamps
- ❖ High Strength Extruded Aluminum Frame with Durable Anodized Finish and Extra Large Padded Tool Tray
- ❖ Unique Internal Drawer System for Storing Tools and Adaptors
- ❖ Convenient Foot Actuated Tensioner Switch
- ❖ String Length Meter



7900 Els

Unpacking Instructions & Contents

Instructions for Unpacking and Preparing for Assembly

The stringing machine is shipped in three cartons, a large master carton for the stringing machine base with tensioner module and accessories, a medium carton for the turntable and mounting system and a smaller carton for the floor stand post and base legs. **Please save the cartons and packing materials for possible shipments in the future.** Gamma Sports cannot be responsible for machines that are not returned, shipped in their original, undamaged packaging. The tools you will need to assemble the machine are provided with the machine. Due to the weight of the tensioner unit, you may need the assistance of someone to help lift the tensioner unit out of the carton.

Once the cartons are opened, remove all inner cartons and check to be sure that all parts are present and accounted for.

Contents of Floor Stand Carton (MMU3-19)

- (1) Lower Column
- (1) Upper Column with Flange Plate
- (4) Legs
- (4) M8 x 30 Flat Head Screws
- (4) M8 x 35 Cap Screws
- (4) M6 x 20 Cap Screws
- (1) String Reel Holder (M8 Threaded Pin), (1) Knob, (10) Spacers, & (2) M8 Washers

Contents of Mounting System Carton (MMU3-21)

- (1) Turntable Assembly w/ String Clamp Base and Mounting Stands w/ Frame Support Slide, Side Supports, and Adapters
- (2) String Clamps
- (1) 5mm T-Handle Hex Wrench
- (1) Package of spare plastic adapters for mounting system supports
- (1) 17mm Socket

Contents of Machine Base Carton (MMU3-17)

- (1) Stringer Assembly Unit w/ Tensioner Module
- (1) Power Cord
- (1) AC Adaptor
- (1) Foot Pedal Tensioner Switch
- (1) Stringing Tool Set - Includes 1 ea Diagonal Cutter, Bent Nose Pliers, Straight Nose Pliers, Starting Clamp, Straight Awl & Pathfinder Specialty Awl
- (1) Tools for assembly and maintenance

ASSEMBLY INSTRUCTIONS

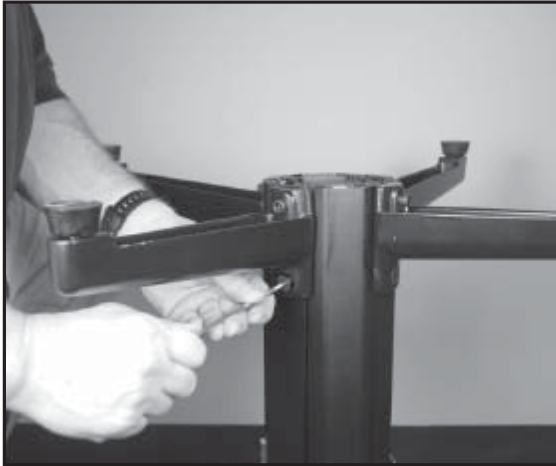

Floor Stand Leg Assembly

The stringing machine uses a four leg floor stand design. The legs must be assembled to the Lower Column before use. Remove all parts from the shipping carton to confirm that contents match the parts list.

Align the holes in the Leg Flange with the matching holes in the Lower Column. Secure the leg with one M8x30 flat head screw through the upper hole, and one M8x35 socket head cap screw through the bottom hole. Repeat this procedure for the three remaining legs.

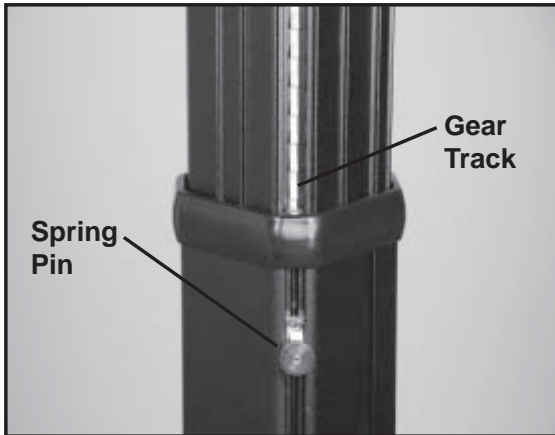

Floor Stand Assembly

The floor stand features a ratcheting Self-Locking system that incorporates a Spring Pin on the lower column to engage a gear track in the upper column. To set the Spring Pin to engage or disengage the Gear Track, pull the Spring Pin Knob out from the housing and rotate it 90 degrees to position the Knob Key into the deep or shallow slot of the Spring Pin Housing. When the Knob Key is positioned in the deep slot, the Spring Pin will be in the Self-Locking position and will engage the Gear Track. When the Knob Key is set

in the shallow slot, the Spring Pin will be retracted and not engage the Gear Track.

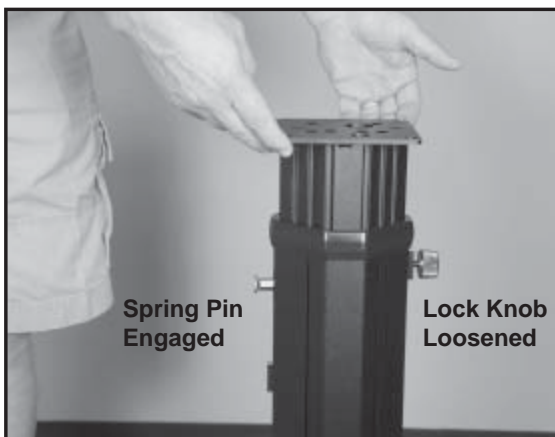

Floor Stand Assembly

With the Spring Pin engaged and the Knob Key positioned in the deep slot, loosen that Lock Knob and lift the upper column. As the upper column is lifted out of the lower column, the Spring Pin will ratchet as it engages and disengages the teeth of the gear track.

To lower the upper column, loosen the Lock Knob and while holding and supporting the upper column, pull out the Spring Pin, set the Knob Key into the shallow slot and lower the upper column.

Helpful Tip: When setting the height, it is best to start from the lowest position and gradually raise the height until the Self-Locking Spring Pin is engaged in the Gear Track at the desired height.

ASSEMBLY INSTRUCTIONS



Attaching the Floor Stand to the Machine Base

Refer to the instruction sheet provided with the floor stand for detailed instructions on which holes of the flange plate to use and align with the threaded inserts located in the slots on the underside of the machine base.

With the floor stand assembled and the upper column locked into position at the lowest height, orient the floor stand so that the string reel holder will be positioned on the left side of the machine base and bolt the floor stand to the underside of the machine base. The

floor stand can be assembled to the machine base with the machine base laying on the floor, or by setting the machine base on top of the floor stand with the help of an assistant to align and balance the machine base on the flange plate while installing and tightening the bolts from the underside.

Caution: To prevent damaging the threads of the inserts in the machine base, do not over-tighten the bolts.



Raising the Height of the Machine

To raise the height of the machine, the Knob Key of the Spring Pin should be positioned in the deep slot of the housing to ensure that the Spring Pin is in the Self-Locking position and engaged with the Gear Track. Loosen the Lock Knob and with the help of an assistant, lift the machine base until the desired height is reached. When the desired height is reached, tighten the Lock Knob.

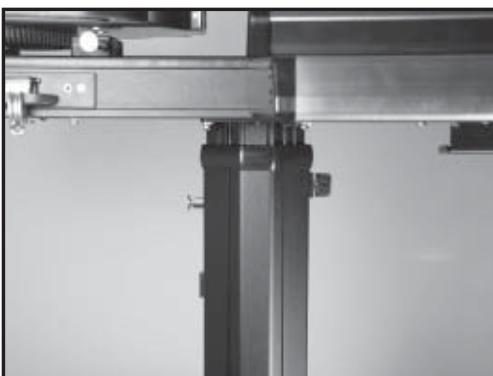

Lowering the Height of the Machine

To lower the machine, you will need the help of an assistant. With one person holding up and supporting the base of the machine, loosen the Lock Knob, pull out the Spring Pin and set the Knob Key into the shallow slot of the spring pin housing. Carefully lower the machine base until it comes to rest on the top of the Lower Column. Pull out the Spring Pin and position the Knob Key into the deep slot of spring Pin housing. Lift the machine base until the Spring Pin engages the first tooth of the Gear Track and tighten the Lock Knob, or

continue raising the machine until the desired height is reached and then tighten the Lock Knob.

CAUTION: To prevent damage to the string gripper, never lift or move the machine by the string gripper.

ASSEMBLY INSTRUCTIONS



Tool Tray Installation

The Tool Tray will be attached to the aluminum extruded machine base on the right hand side below the tensioner. To install the tool tray orient the tray at an angle and carefully insert the keyed tabs into the horizontal slot along the top edge of the base.

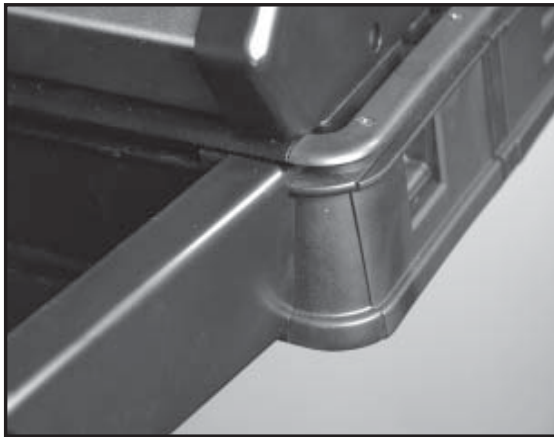

With the keyed tabs located within the slot in the machine base slide the tray to the right edge of the machine and next to the corner cap of the base. Rotate the tray down until it is flush against the machine base.



Secure the bracket on the rear of the Tool Tray to the machine base with two hex head bolts. Align the two holes in the bracket with the threaded holes in the threaded insert located in the machine base. Tighten the bolts with a 6mm hex wrench.

Caution: To prevent damaging the threads of the inserts in the machine base, do not overtighten the bolts.

Note: If the holes in the bracke do not line up with the holes in the threaded insert, loosen the set screw in the threaded insert and slide the threaded insert to the left or right until the

holes line up and tighten the set screw to lock the threaded insert in place.

ASSEMBLY INSTRUCTIONS

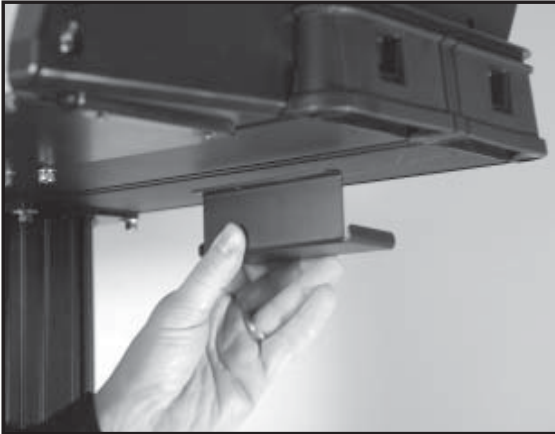

AC Power Adapter Storage Shelf

The AC Power Adapter Storage Shelf provides a means to secure and protect the power adapter by storing it safely under the machine base. This will reduce a potential tripping hazard as well as eliminate potential damage to the AC Power Supply if laying on the floor.

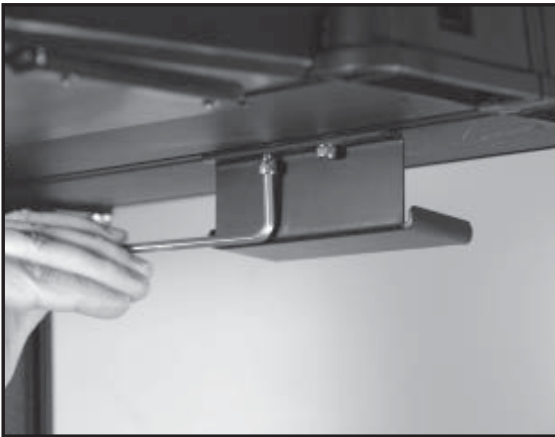

AC Power Adapter Storage Shelf

Mount the Storage Shelf to the threaded insert in the machine base near the rear right corner. Align the holes in the storage shelf bracket with the holes in the threaded insert. Use a 6 mm hex wrench to tighten the two hex head cap bolts.

Caution: To prevent damaging the threads of the inserts in the machine base, do not overtighten the bolts.

Note: If the holes in the bracket do not line up with the holes in the threaded insert, loosen the set screw in the threaded insert and slide

the threaded insert to the left or right until the holes line up and tighten the set screw to lock the threaded insert in place.



AC Power Adapter Storage Shelf

Place the AC Power Adapter onto the storage shelf. The excess cable can be coiled up and placed between the top of the AC Power Adapter and the machine base.

ASSEMBLY INSTRUCTIONS

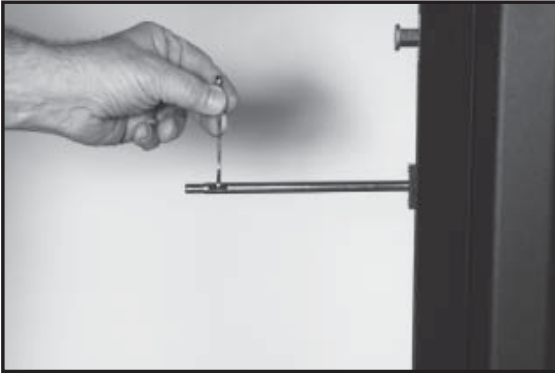

String Reel Installation

The String Reel Holder pin is an 8 mm rod with threads on both ends and flat surfaces machined on one end. Thread the end of the rod without the flat surfaces into the threaded boss on the right side of the Lower Column. Using the M6 open end wrench positioned on the flat surfaces, securely tighten the rod to the Lower Column.

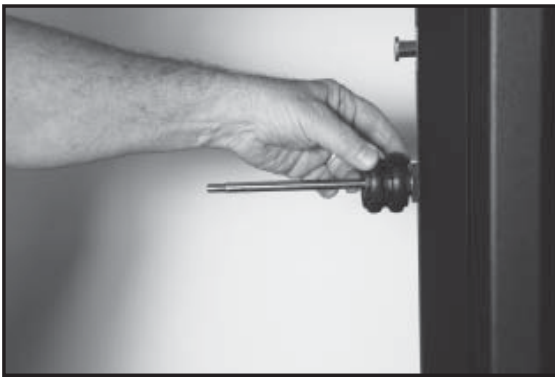

The String Reel Holder can hold up to 4 reels of string (depending on the size of the string reel). Before placing the first reel on the rod, slide two spacers over the pin and slide them to the boss on the Lower Column.

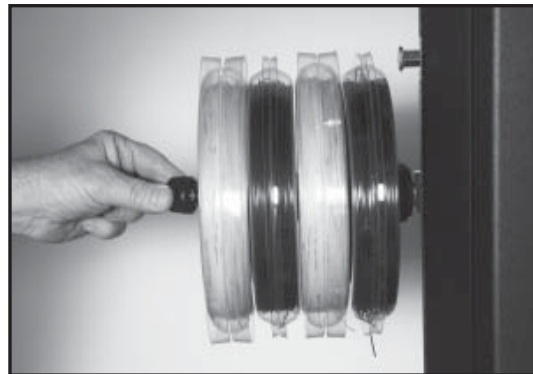
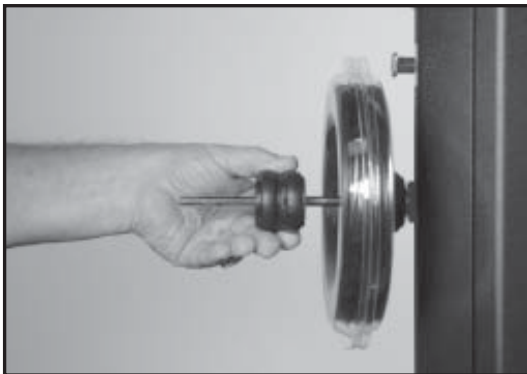

After the first reel is placed onto the rod, place two spacers between each reel to provide enough space between reels to allow them to turn freely without rubbing against one another. (To provide a smooth feed to the String Length Meter, place the reels on the rod so the string spools off the reel from the underside of the reel).

After the last reel is installed, place two washers on the rod and attach the threaded knob to the end of the rod.

Note: The String Reel Holder can be repositioned anywhere you wish on the lower column by loosening the set screws in the threaded boss and repositioning the threaded boss in the lower column.

ASSEMBLY INSTRUCTIONS

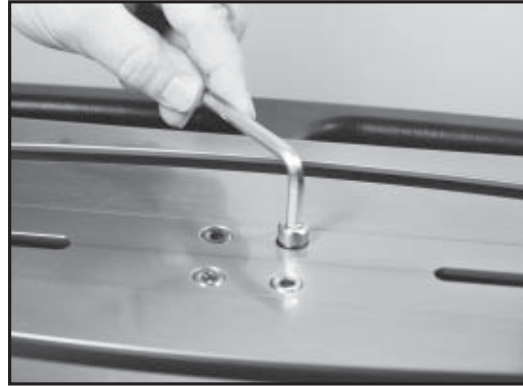
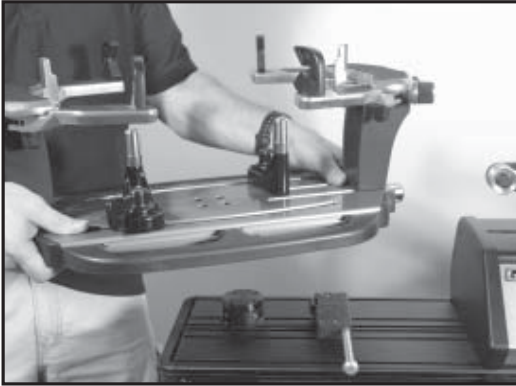

Turntable and Mounting System Installation

To install the Turntable position the Turntable over the turntable pin and align the holes in the turntable with the holes in the turntable pin. Insert the bolts through the holes in the turntable and turntable pin and tighten with an M6 hex wrench.

STRING CLAMP INSTALLATION

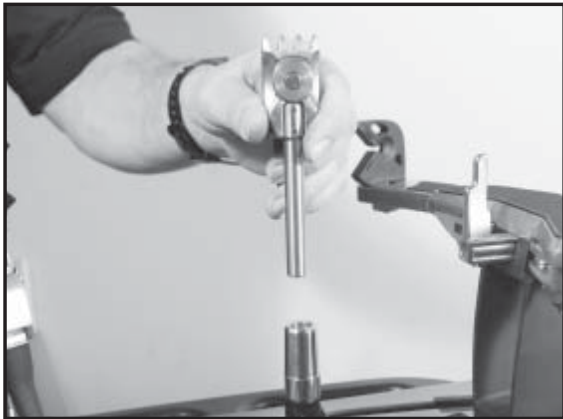

String Clamp Installation

The post of the String Clamp and tube of the String Clamp Base may be treated with grease to provide protection against corrosion during shipping and while in storage. Remove any excessive grease with a clean cloth prior to use. The post and tube may also be cleaned with isopropyl alcohol. After this type of thorough cleaning, the post and tube should be treated with a light coating of machine oil to protect the surfaces against corrosion and to ensure smooth operation.

POWER CONNECTION & CONTROLS

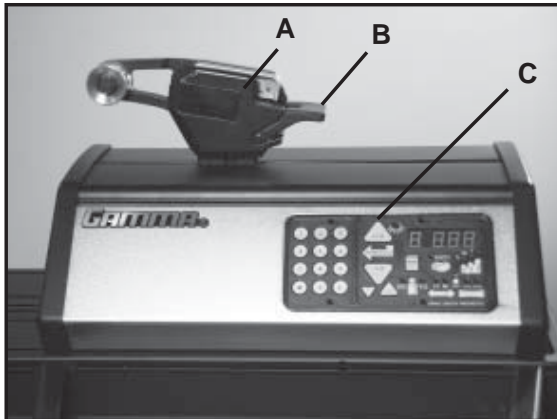

Front Panel Features

- A - String Gripper
- B - Tension Lever Switch
- C - Control Panel with LED Display

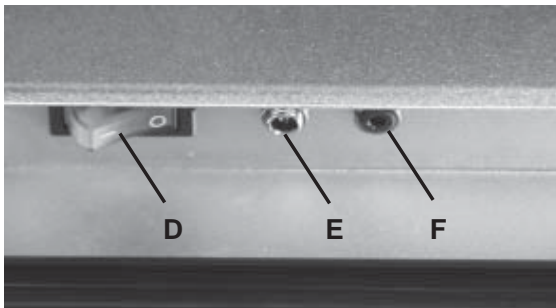

Back Panel Features

- D - Power Switch
- E - A/C Power Cord Socket
- F - Foot Pedal Switch Receptacle

Instructions for Power Connection and Controls

CAUTION ! Before connecting to the power supply, check the voltage source that the machine is being connected to. The acceptable range of input voltages for this machine is between 100 V and 240 V @ 50 to 60 Hz. If you have any questions regarding the input voltage supply for your area, please ask your electric utility company.

To install the power cord, insert the female end of the power cord into the AC Adapter and then insert the female end of the cord from the AC Adapter into the A/C Power Cord Socket "E" located under the back panel of the tensioner. Plug the male end of the power cord into a grounded power outlet. When using extension cords, use grounded heavy duty extension cords rated for 15 AMP service.

To connect the Foot Pedal Switch, insert the male pin at the end of the Foot Pedal Switch cord into the Foot Pedal Switch Receptacle "F" located under the back panel of the Tensioner.

Switch on the machine by pressing the On-Off Power Switch on the back panel. At start-up, the machine will perform a self diagnostics check.

**WARNING! FOR INDOOR USE ONLY.
NEVER OPEN UNIT WITH POWER CONNECTED.
CHILDREN SHOULD NEVER BE PERMITTED TO OPERATE THIS
MACHINE WITHOUT ADULT SUPERVISION.**

CONTROL PANEL FEATURES

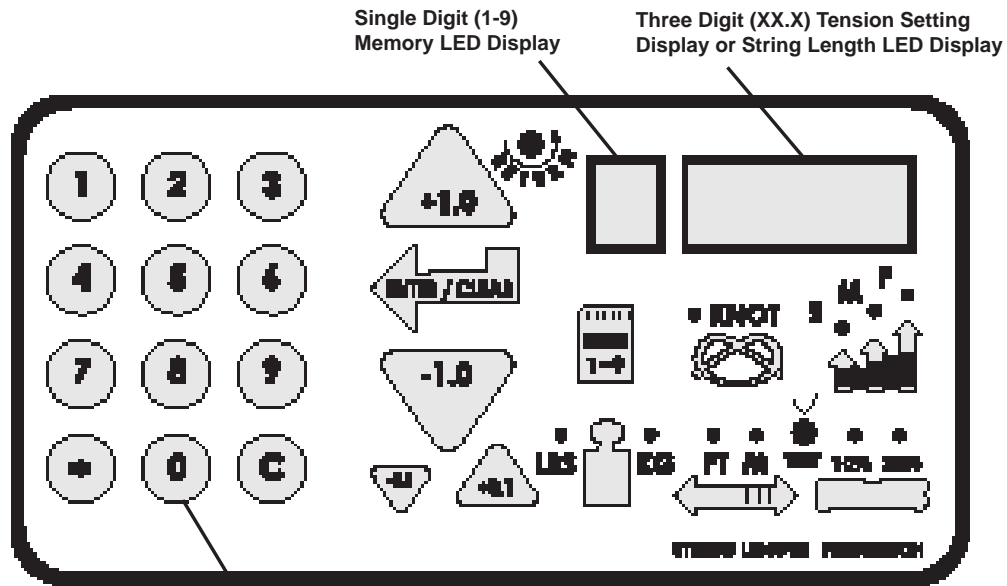

12 Button Keypad - Used to enter tension settings

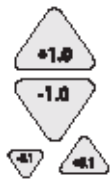

Tension Index Buttons - Changes tension setting in +/- 1.0 or +/- 0.1 Lb or Kg increments. Holding the button down will scroll the tension setting values up or down. Tension settings entered with the tension index buttons are placed into temporary memory setting "0".



Memory Button - Indexes from 9 preset tension settings that can be stored in memory. Settings are retained even if machine is turned off. Each press of the button indexes to the next memory setting. Memory settings 1-9 must be entered using the keypad followed by pressing the "ENT" button.



Clear Button - Clears display to enter a new tension or to reset String Length Meter measurement.



Enter Button - Saves displayed tension for Memory setting - when tension is entered using the keypad display flashes until this button is pressed to save the setting. Also Clears display for String Length Meter measurements.



Test Button & Racquet Strung - Press once for approximate number of racquets strung. Press again to return. Press and hold for 5 seconds and the machine does an internal diagnostic check, such as the one performed at start-up.



Knot Function - Increases pulling tension by 10% over the setting value (max 90 lbs / 40.8 kgs) for one pull. During the pull the LED stays lit to indicate the Knot function is enabled.



Lbs/Kgs Button - Changes tension display from Lbs to Kgs. Each press of the button toggles back and forth between Lbs and Kgs.



Speed Button - Changes pulling speed of winder from Fast (default) to Medium to Slow. Slow speed is recommended for low stretch strings, such as Kevlar. Each press of the button toggles between Fast, Medium and Slow speeds.



Pre-Stretch Function - Pulls string 10% or 20% over the tension setting (up to 90 lbs / 40.8 kgs), releases the string, and repulls to the tension setting. Each press of the button toggles between 10%, 20% or no pre-stretch.



String Length Meter Button - Enables string length meter function. Each press of the button toggles between Meters and Feet. To switch back to tensioning function, press the "Lbs/Kgs" button.

STRING GRIPPER OPERATION

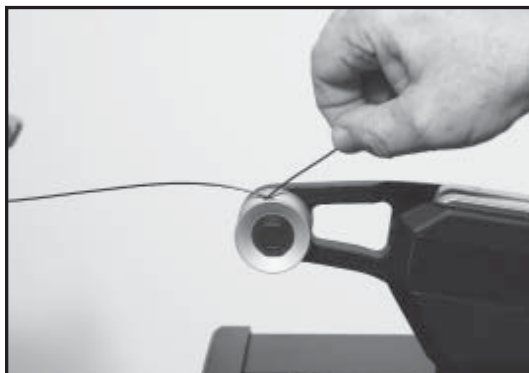

String Gripper Operation

To insert a string into the Quick Closing linear string gripper, wrap the string clockwise around the string guide and insert the string between the string gripper plates. Excessive slack in the string should be removed before applying tension. **Pull the string perpendicular to the gripper plates while pressing the tension lever located at the rear of the gripper.** As tension is applied, the gripper jaws will engage to hold the string. To release tension on the string depress the tension lever switch or use the foot pedal switch.

For adjustment of the parallel plates, see "Setting the Gripper Plate Spacing" on page 22.

CAUTION: NEVER TENSION A STRING WITH YOUR FINGERS BETWEEN THE STRING AND THE STRING GUIDE AS SERIOUS INJURY COULD RESULT IF YOUR FINGER IS CAUGHT BETWEEN THE STRING AND STRING GUIDE DURING TENSIONING. PUSH ANY BUTTON TO RELEASE TENSION.

MOUNTING THE FRAME

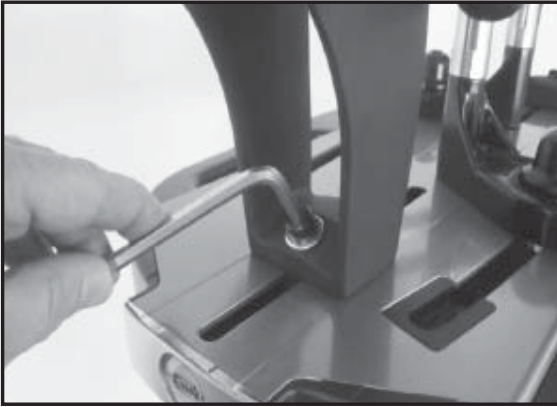

Adjusting the Frame Mounting Stands

Loosen the lock bolts of the frame Mounting Stands and space them apart with the Frame Support Slides separated by the approximate length of the racquet head. Although it is not required, it is good practice to center the Mounting Stands on the Turntable. Lock one of the stands in position by tightening the 6 mm Hex Head lock bolt and position the other stand until the Frame Support Slide is positioned near the inside surface of the

racquet frame. Securely tighten the lock bolt of the second Mounting Stand.

Caution: To avoid racquet damage, the Frame Supports should not contact the racquet prior to locking down the Mounting Stands.



Tightening the Frame Supports

Tighten the Frame Support Slides by turning the Adjustment Knob clockwise until it is snug against the racquet frame and slight resistance is felt.

Caution: Overtightening the Center Supports will stretch the head of the racquet and could cause racquet damage.

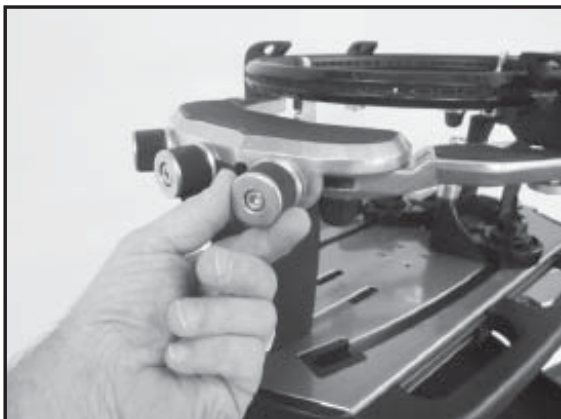

Frame Shoulder Support Adjustment

Simultaneously rotate the Shoulder Support Adjustment Knobs clockwise until both Shoulder Supports gently and squarely contact the frame. Adjust until firm contact is made between the Shoulder Supports and the frame. Re-adjust the stand position as needed to ensure that the Frame Supports are in firm contact with the racquet at 6 and 12 o'clock. Do not over tighten any of the supports as racquet deformation may occur. The supports should be tightened to the point where the racquet frame will not move in the Mounting System when the handle is

grasped and attempts are made to move it. Should any supports lose contact with the frame while stringing, they should be re-tightened.

MOUNTING THE FRAME

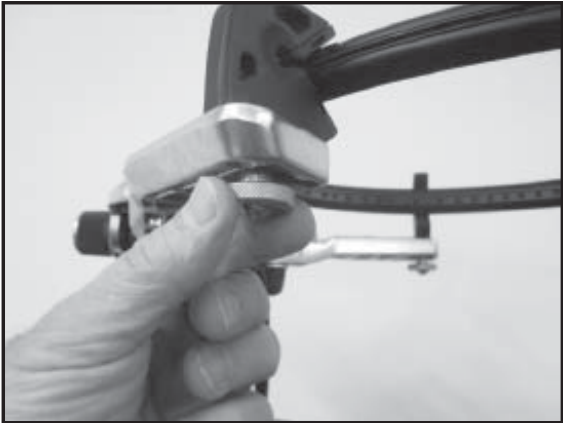

Securing the Frame Shoulder Clamps

The shoulder supports are designed to rotate and can be adjusted to provide maximum support to the racquet frame. Rotate the support so that the pads contact the frame squarely when the arms are closed against the racquet. Should the shoulder supports block string holes, adjust the frame support slides to re-position the racquet between the arms so the shoulder supports make contact with the racquet between grommet holes. Lock the Shoulder Supports in position by turning the knob at the base clockwise.

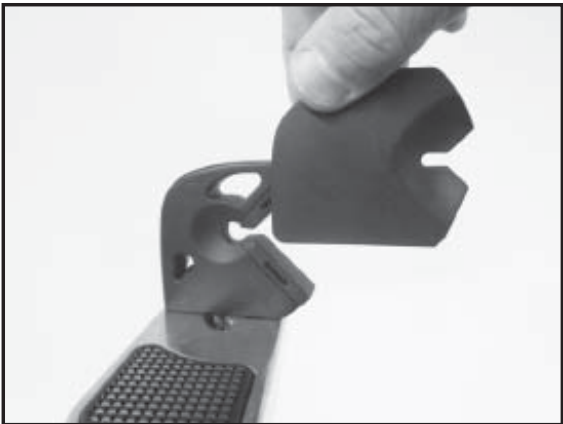

Badminton Shoulder Support Cover

When stringing badminton racquets, slide the Badminton Shoulder Support Cover over the Shoulder Supports. There is no need to remove the Tennis Shoulder Supports.

Note: Special three finger Badminton Frame Supports for the head and throat of the racquet are also available as an optional accessory to reduced the pressure between the frame support and badminton frame as strings are installed under tension.

STRINGING THE FRAME



String Clamp Operation

The String Clamps are a dual action design where the String Clamp and Clamp Base operate independently of one another.

To clamp a string, lift the String Clamp and place the string between the jaws and depress the String Clamp Lever to secure the string. The clamping pressure applied to the string should be adjusted to provide sufficient pressure to secure the string when subjected to the desired pulling tension. The textured surface of the teeth provide for increased friction between the clamps and the string to allow for reduced

clamping pressure while securing and holding the string under tension.

Note that excessive pressure can damage both the strings and String Clamp.

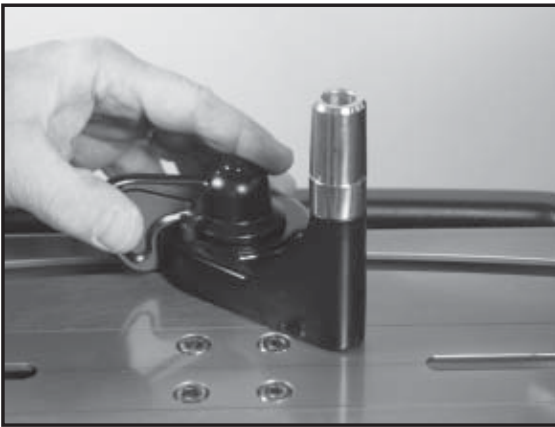

Clamp Base Operation

To lock the String Clamp Base to the Turntable, rotate the Clamp Base locking lever clockwise. To release the String Clamp Base from the Turntable, rotate the clamp base locking lever counter-clockwise.

The locking lever should be tightened enough to prevent Clamp Base slippage on the Turntable when the desired tension is placed on the string. To adjust the Clamp Base refer to page 23.

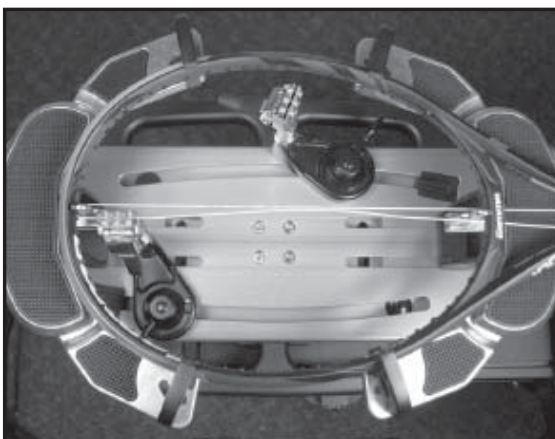

Stringing the Mains

Follow the manufacturer's recommended stringing pattern for one or two piece stringing.

To determine which end of the racquet to start installing the string count the number of grommet holes located in the throat bridge. If there are 2 or 6 holes start main strings at the center 2 holes of the throat bridge. If there are 4 or 8 holes start the main strings at the center 2 holes at the tip of the racquet.

To begin stringing the main strings, thread the two ends of the string through the two center holes at the appropriate end of the frame and continue through the opposite center holes. Thread one end of the string through the adjacent grommet hole and pull excess by hand. Secure one of the strings using a string clamp.

STRINGING THE FRAME



Pulling Tension

Remove excessive slack in the string before applying tension. To apply tension to the main string, wrap the string clockwise around the String Guide to ensure that the proper tension will be applied to the string.



Insert the string between the String Gripper Plates and apply tension to the string by pressing the Tension Lever Switch or the Foot Pedal Switch. Pull the string towards you at a slight angle to engage the gripper plates. As the gripper plates slide to the left, they close and will grip the string. The Gripper will move to the right, away from the racquet, and gradually apply tension to the string. To release the tension on the string depress the tension release lever at the rear of the gripper or use the Foot Pedal switch.

For adjustment of the parallel plates, see “Setting the Gripper Plate Spacing” on page 22.

CAUTION: NEVER TENSION A STRING WITH YOUR FINGERS BETWEEN THE STRING AND THE STRING GUIDE AS SERIOUS INJURY COULD RESULT IF YOUR FINGER IS CAUGHT BETWEEN THE STRING AND STRING GUIDE DURING TENSIONING. PUSH ANY BUTTON TO RELEASE TENSION.

NOTE: The tensioner has a built in safety that will shut down the motor if a string is not released within 60 seconds from the time the tensioner is activated. Note that after the motor is shut down, the set tension in the string will no longer be maintained.

STRINGING THE FRAME

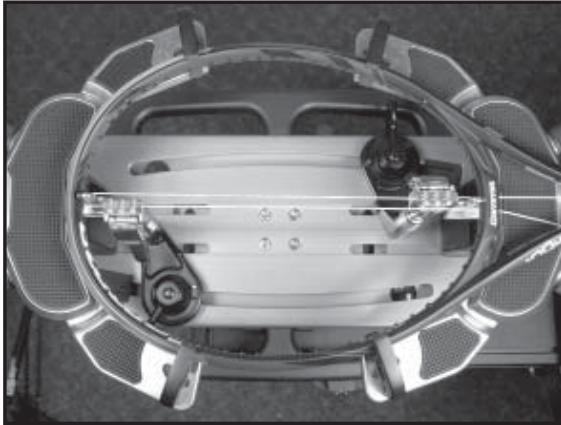

Clamping the First Main String

Secure the tensioned main string using the remaining fixed clamp. Repeat the procedure for all of the remaining main strings and tie off at the appropriate holes following the racquet manufacturers specifications.

This will determine the starting point for the cross strings. If applicable, tie the first cross string using an appropriate starting knot.

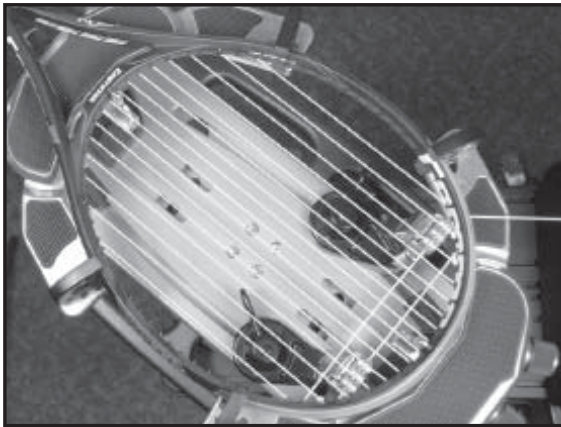

Weaving the Cross Strings

Weave the cross strings over and under the main strings being careful to alternate the weave of each consecutive cross string to be opposite of the previously installed cross string.

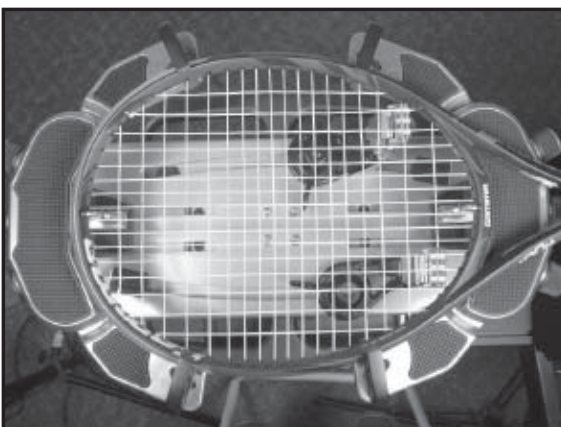

Completing the String Job

Once the final cross string is tensioned and clamped, tie off at the appropriate hole specified by the racquet manufacturer. Remove the frame from the Mounting System by loosening the Shoulder Supports and Frame Supports.

STRING LENGTH METER OPERATION

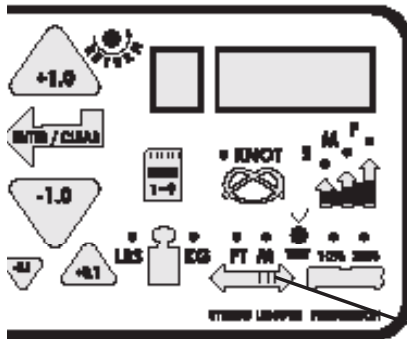

String Length Meter

Press the String Length Meter (SLM) button to enable the SLM function and display the SLM screen. To change the measurement units from feet (FT) to Meters (M) press the SLM button to toggle between FT and M.

String Length Meter (SLM) button

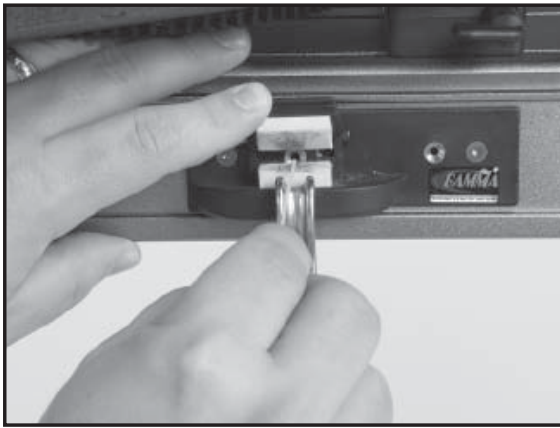

To measure a length of string from a reel or set of string, insert the end of the string through the loop from the backside of the string guide attached to the front of the SLM. Lift the clamp pad and insert the string through the entry hole on the face plate of the SLM. Continue to feed the string into the entry hole until it exits the SLM through the hole on the right side and release the clamp pad. (In addition to aligning the strings with the entry hole to the SLM, the felt clamp pads apply a slight amount of pressure to the string and wipe down the surface of the string to prevent debris from entering the SLM).

NOTE: When measuring thin strings such as badminton strings, apply light finger pressure to the clamp pad to provide some back pressure while pulling the string through the meter to prevent slipping and obtain more accurate measurements.



When the end of the string exits through the hole on the right, press the ENTER button to “Zero” the String Length Meter, and the length of string will be measured from the point on the string located at the edge of the exit hole. Pull the end of the string at a slow steady rate and the SLM will begin measuring the length of string as it is pulled through the SLM and indicate the measurement on the display. When the desired length of string is measured, cut the string at the edge of the exit hole.

NOTE: When reaching the end of a string, pull the string through the SLM slowly to avoid inaccurate measurement.

The measurement accuracy of the SLM is approximately +/- 0.5% of the indicated value for thicker strings when the tension is set for 35 lbs and higher and badminton strings when the tension is set for under 35 lbs prior to measurement.

ADDITIONAL FEATURES



Turntable Brake

The Turntable may be locked in any position.

To lock the Turntable Brake pull the brake lock pin OUT.

To release the Turntable Brake push the brake lock pin IN.



Storage Drawers

There are two Storage Drawers located in the base of the machine. The drawers open from the right side of the base and lock into the end cap with a spring loaded latch.

To open the drawers depress that latch in the face of the drawer and slide them out to the right. To close the drawers simply slide the drawers back inside the base and the latch with automatically lock into place.



Turntable Clutch

To adjust the free rotation of the turntable, turn the Turntable Clutch bolt located on the left end of the base clockwise to add friction and restrict rotation or turn the Turntable Clutch bolt counter-clockwise to reduce the friction and allow the turntable to rotate more freely.

PATHFINDER AWL

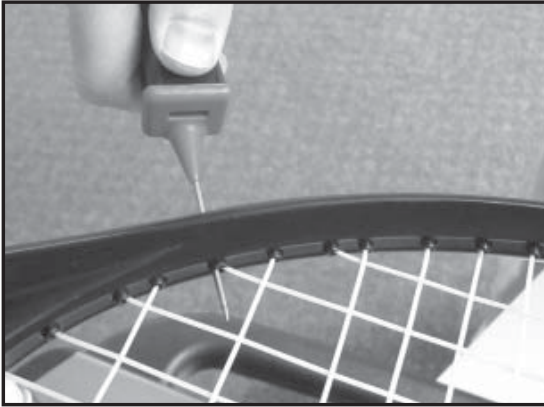

The machine includes the Pathfinder Stringing Awl which creates a pathway between or around strings to make inserting a string through blocked grommets easier and quicker.

Insert the awl through the grommet hole in the same manner as for traditional awls. The Pathfinder Awl must be in the closed position before insertion.

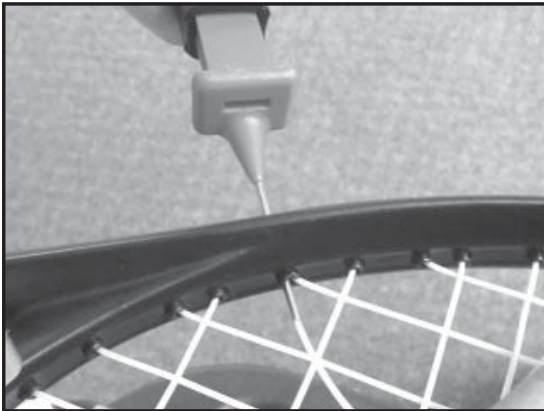

Once the awl is inserted, pull the handle of the awl outward while holding the tip section in place. This leaves the outer sheath in the grommet hole. Insert the end of the string into the outer sheath.

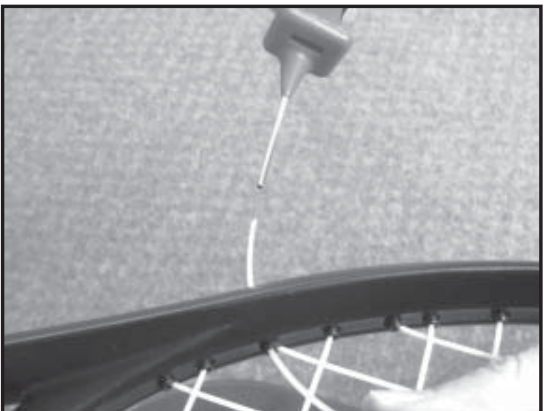

While holding the string, slowly pull the sheath out of the grommet hole to leave the free end of the string exposed.

MAINTENANCE & ADJUSTMENTS

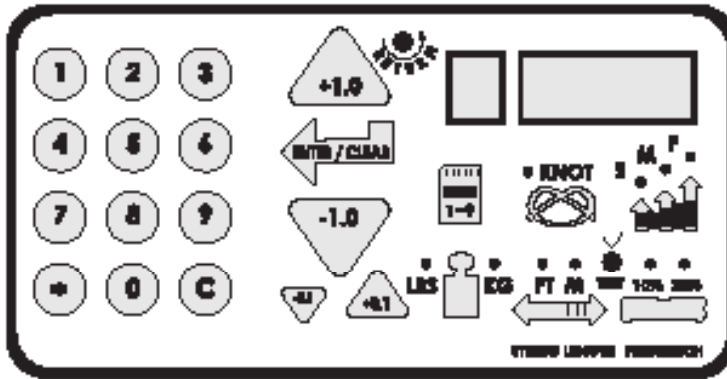

Tension Calibration Procedure

During power up press the TEST button to enable the calibration mode.

The display will show 22 lbs or 10 kgs. KG/LBS can be changed at any time by pressing the LB/KG Button.

Using a Tension Calibrator, apply tension to the calibrator

and adjust the value on the display up or down to match the reading on the calibrator. Press the ENTER button to confirm. Release the tension on the calibrator.

When the Gripper returns to the home position the display will now show 44 lbs or 20 kgs. Apply tension to the calibrator and adjust the value on the display up or down to match the reading on the calibrator. Press the ENTER button to confirm and release the tension on the calibrator.

When the Gripper returns to the home position the display will now show 66 lbs or 30 kgs. Apply tension to the calibrator and adjust the value on the display up or down to match the reading on the calibrator. Press the ENTER button to confirm and release the tension on the calibrator.

When the Gripper returns to the home position the display will now show 88 lbs or 40 kgs. Apply tension to the calibrator and adjust the value on the display up or down to match the reading on the calibrator. Press the ENTER button to confirm and release the tension on the calibrator. The Calibration procedure is now complete.

NOTE: If ESC is pressed at any time during calibration, the calibration procedure will be terminated and no new calibration data will be saved.

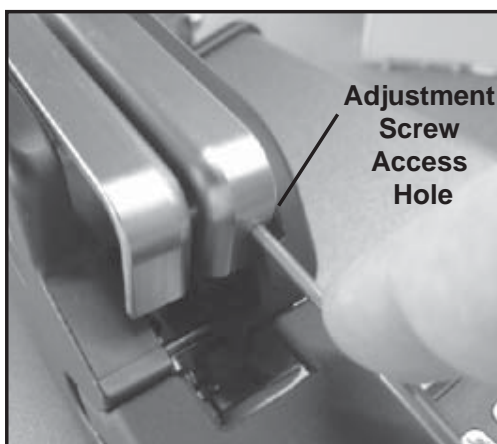

Gripper Plate Spacing Adjustment

The Gripper Plates of the String Gripper are adjustable to accommodate various string gauges and types of string. If the string slips through the Gripper Plates while pulling tension, insert a 2.5mm hex wrench through the access hole on the back of the right Gripper Plate and into the Adjustment Screw. Turn the Adjustment Screw clockwise to increase the compression on the string. If too much pressure is applied to the string while pulling tension, rotate the Gripper Adjustment Screw counter-clockwise to reduce the compression on the string. The Gripper Plates are properly adjusted when there is enough pressure to securely hold the string without slipping and without excessively compressing the string.

TIP: If you turn off the machine with the Gripper located at the far right side of the track, it is easier to access the Adjustment Screw.

MAINTENANCE & ADJUSTMENTS

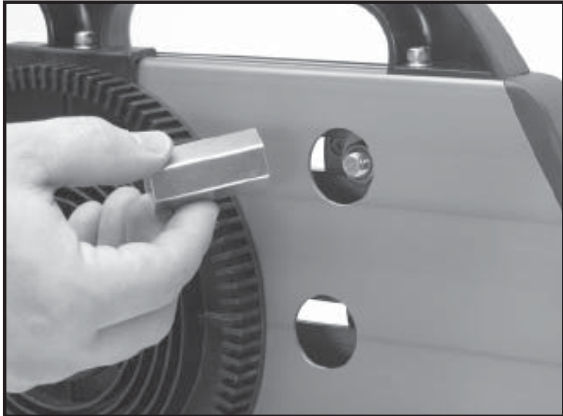

Adjusting the Clamp Base

In the event the Clamp Base Locking Lever rotation is insufficient to ensure smooth operation of the Clamp Base, very minor adjustments to the Clamp Base Locking Nut can be made with a 17mm socket. Tighten or loosen the locking nut in very small increments to provide more clamping pressure or running clearance as needed.



Clamp Base Removal

Clamp Bases can be removed from the Turntable for maintenance or cleaning by removing the Clamp Stop located at the end of the slot in the Turntable. To remove the Clamp Stop, remove the two screws holding the Clamp Stop in place from the underside of the Turntable. Lift the Clamp Stop out of the slot, slide the Clamp Base to the end of the slot and lift it out. Replace the Clamp Base and clamp stop in reverse order.

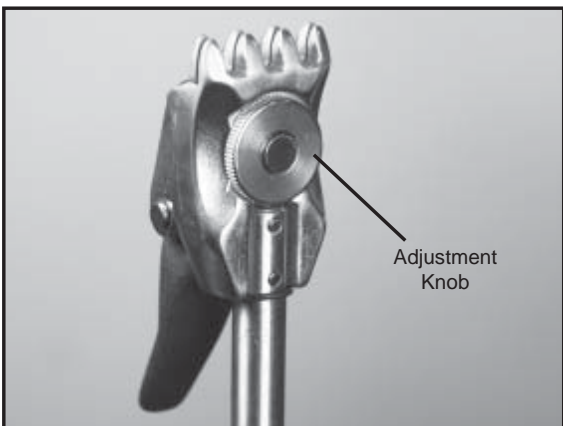

Adjusting String Clamp Jaw Spacing

The String Clamps will need minor adjustments according to what string type, construction, and gauge you are using. To adjust the gap (clamping pressure) between the clamp jaws, insert the string through the racquet as if you were beginning the main strings. Clamp the strings and pull tension. If the string slips through the jaws of the clamp, tighten the clamp by turning the Adjustment Knob, in the clockwise direction. If the clamp leaves impressions in the string, it may be excessively tight and should be adjusted by

turning the Adjustment Knob counter clockwise to increase the gap between the jaws.

NOTE: Due to the bearings used in the clamp lever the action of the clamp lever is very light making it easy to apply excessive clamping pressure. Clamps that are set too tight can damage the string as well as the string clamp jaws.

The clamp jaws should be cleaned periodically to be free from dirt, oil, and any residual string coating for them to grip properly. The cleaning stone supplied with the machine is excellent for removing build-up on the diamond coated surfaces. Rub the gripping surfaces with the cleaning stone and remove any residual dust with a brush or cloth and isopropyl alcohol.

TROUBLESHOOTING TIPS

<u>PROBLEM</u>	<u>SOLUTION</u>
String slips in clamps	<ul style="list-style-type: none">- Adjust gap between clamp jaws- Clean clamp jaws
String slips in gripper	<ul style="list-style-type: none">- Adjust gripper jaw stop screw- Clean gripper jaws
String clamp base slips on turntable	<ul style="list-style-type: none">- Clean bottom of clamp & top of turntable with alcohol- Adjust clamp base locking nut
String tension too tight or too loose	<ul style="list-style-type: none">- Check tension using a tension calibrator, adjust machine calibration if necessary
Electrical system does not function	<ul style="list-style-type: none">- Check power source- Check power cord connections

CARE & CLEANING

With time and use, the clamping surfaces of your machine may become oily or dirty and result in string or clamp slippage while stringing. Periodic cleaning of the String Clamps, String Clamp Base and String Gripper is recommended. The supplied Cleaning Stone or a knife sharpening stone works well for cleaning the diamond coated string clamping surfaces. Cleaning with a solvent such as isopropyl alcohol and a mild abrasive tool such as a toothbrush also works well to remove oily or greasy build up.

NOTES

PARTS SUMMARY

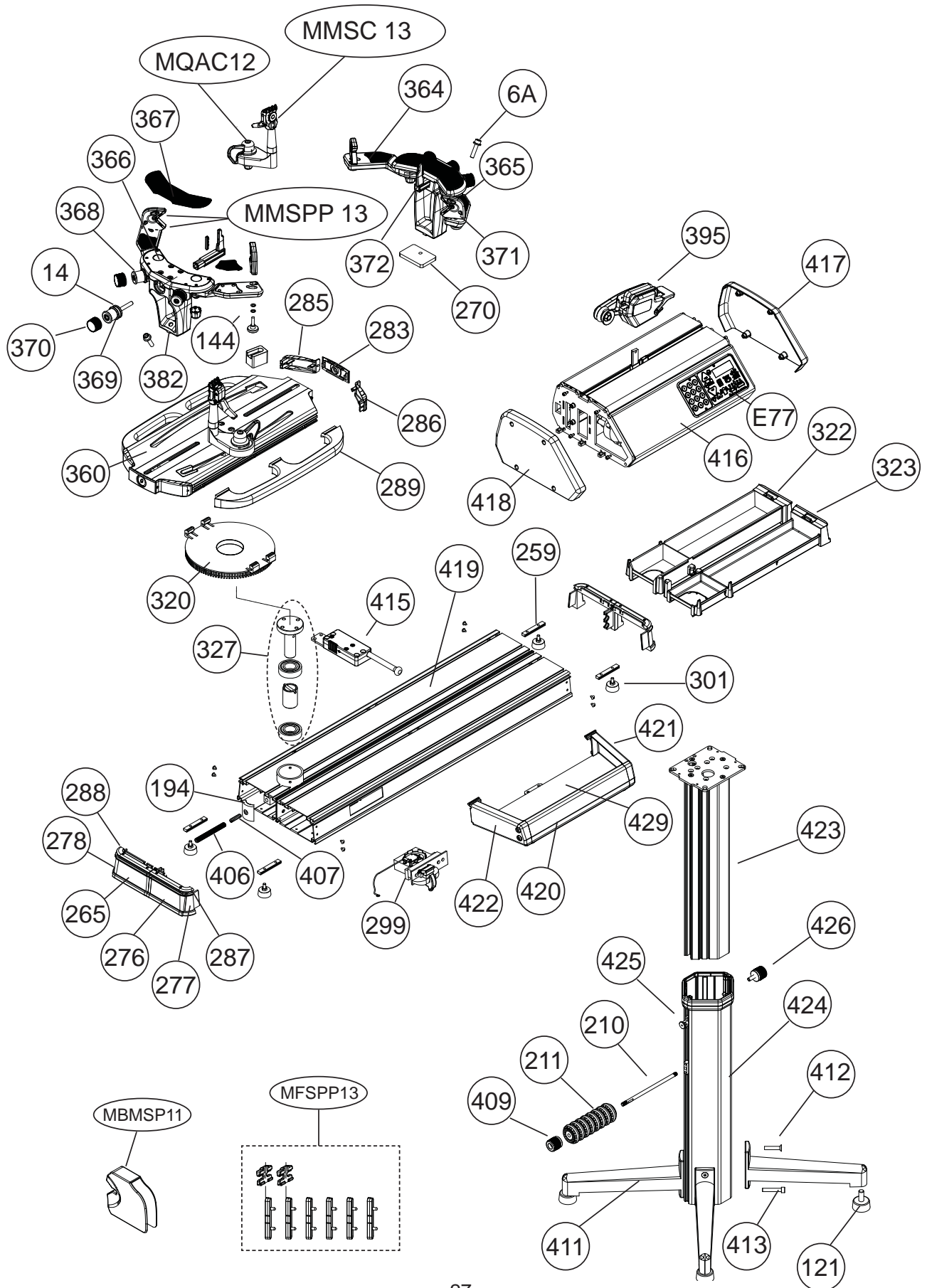



MMAN-56
(MG79E-10)

GAMMA SPORTS

200 Waterfront Drive
Pittsburgh, Pennsylvania 15222
Phone: 800.333.0337 Fax: 412.323.0317
Visit our website at www.gammasports.com