

E

**SAFETY INSTRUCTIONS**

Thank you for purchasing this product. Please read and follow the instructions carefully and keep this manual for future reference.

- This device is not intended for use by persons ( including children ) with reduced physical, sensory or mental capabilities, or lack of experience and knowledge, unless they have been given supervision or instruction concerning use of the device by a person responsible for their safety.
- Keep this device out of reach of children. Do not let them play with the device.
- Stop using if the plug or cord is damaged, or the plug fits loosely in the outlet.
- In case of malfunction, get the device repaired by the authorised service centre.
- This device must be earthed. Make sure the mains voltage corresponds to that printed on the rating plate of the device.
- Unplug the device when not in use or before cleaning.

**PRODUCT OVERVIEW**

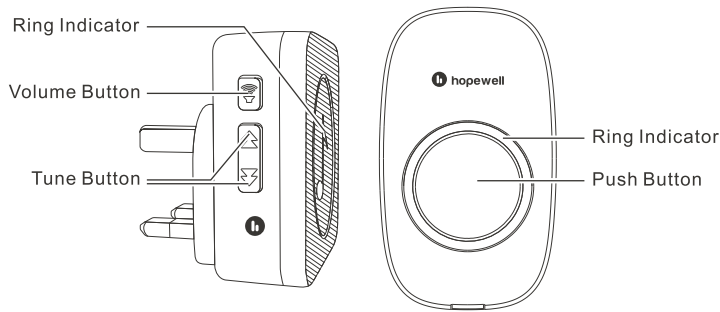

**CONNECTING POWER**

- 1 - Unclip the cover from the bell push.  
- Insert a 12V 23A battery into the battery compartment, put the cover back on.

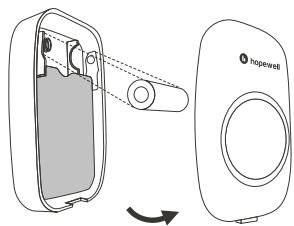

- 2 Plug the chime into the socket outlet.

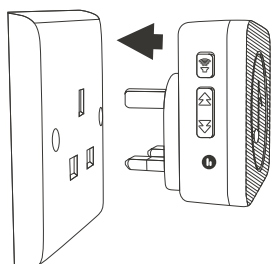

**ADJUSTING VOLUME**

- 1 Press the [ Volume Button ] repeatedly to adjust the ring volume.

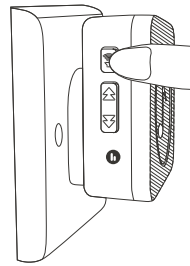

**SETTING TUNE**

- 1 Press the [ Tune Button ] repeatedly to select a desired ringtone.

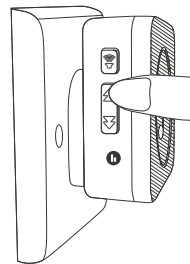

- 2 Press and hold the [ Volume Button ] for 5 seconds until you hear a tone and the indicator flashes.

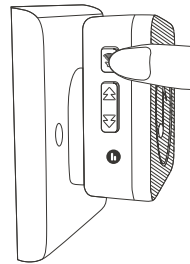

- 3 Press the [ Push Button ] once, the selected tune can be heard.

( Note : Please complete this step within 5 seconds after the tone is heard. The chime will exit the set-up mode after 5 seconds. To re-enter the set-up mode, press and hold the [ Volume Button ] for 5 seconds again. )

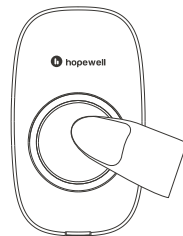

- 4 The indicator goes off, tune set-up completes.

**FAQ**

**My chime does not ring by pressing the [ Push Button ], any fix?**

Your chime and bell push may have been accidentally unpaired. You can try to reconnect them by setting the tune again. Please follow step 1 - 4 in the " SETTING TUNE " section above.

**PAIRING ADDITIONAL BELL PUSHES / CHIMES**

- Unlimited numbers of additional bell pushes and chimes can be added.
- To pair a new bell push or chime, follow the steps in "SETTING TUNE".
- To pair multiple bell pushes or chimes, simply repeat the steps in "SETTING TUNE".

- 1 bell push can be paired with multiple chimes; multiple bell pushes can be paired with 1 chime; or multiple bell pushes can be paired with multiple chimes.
- E.g. If you wish to pair 2 bell pushes with 3 chimes, pair the first bell push with the 3 chimes first, then pair the second bell push with the 3 chimes.

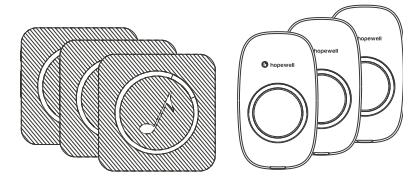

\* Expandable with all DB, DK, MD, MDK Models

- To unpair a chime with all bell pushes and reset the ringtone, press and hold the [ Tune Button ] for 5 seconds until you hear a tone and the indicator flashes.

**CARE AND CLEANING**

**NOTES**

- Switch off and unplug the device before cleaning.
- Never immerse the device, plug or cord in water.
- The electrical connections or switches must not come into contact with water or liquid.



- Wipe dust off the surface of the device using a dry, soft cloth. If necessary, use a damp well-wrung cloth containing a few drops of mild detergent to remove persistent stain, then clean and dry.
- Do not use abrasive tools, they will scratch the device surface.

**PROPER DISPOSAL**



To help protect the environment, dispose of your device separately from household waste at the end of its working life. It can be taken to appropriate collection points provided in your country. Product marked with a crossed-out wheeled dustbin means that it must be disposed of properly according to local laws and regulations.

**TROUBLESHOOTING**

| Problem   | Possible Cause                                       | Solution   |
|---|--|--|
| Chime has no sound even by pressing the [ Volume Button ] or [ Tune Button ].                           | No power.  | Check if the chime has been firmly plugged into the power outlet.<br><br>Check if the power outlet has been switched ON. |
|   | Unstable or incorrect voltage.                       | Check if your voltage is stable and corresponds with that printed on the rating plate at the back of the chime.          |
| Chime does not ring, but the bell push's ring indicator goes ON while pressing the [ Push Button ].     | Chime and bell push have been accidentally unpaired. | Follow the steps in the " SETTING TUNE " section to reconnect them.  |
| Chime does not ring, and the bell push's ring indicator remains OFF while pressing the [ Push Button ]. | Bell push runs out of battery.                       | Change the battery.  |