

# ASSEMBLY INSTRUCTIONS

**MODEL : MX2 LCS750**  
**DESC : MEDIUM HEIGHT CABINET WITH WOODEN DOOR**

DOC. NO : RD-F05-AT  
REV. NO : A  
REV. DATE : 25.08.2006

Thanks you for purchasing this quality product. Be sure to lay all components on a soft and clean surface before assembly in order to avoid components from being scratched.

## CAUTIONS :

1. Check contents against list for quantity.
2. Familiarize yourself with the components and hardware by reviewing the Assembly Instructions.
3. Do not over tighten the screws and bolts as it may damage the threads.
4. Keep all hardware parts out of the reach of children.

REV. :A DATE : 09-12-2021

Remark: At least 2 person to assembly this product.

## PANEL

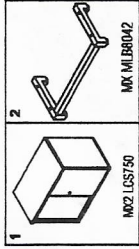

## HARDWARE

A	Resinx	12 Pcs
B	Housing	12 Pcs
C	Mixing cap	12 Pcs
D	Shell Support Sakura	4 Pcs
E	L-KEY	1 Pcs
F	Flush Lock	1 Set
G	M3.5 x 12 CSB Screw	2 Pcs

PACKED WITH MX2 LCS750

## HARDWARE

I	#6 x 16mm P/1 Cross House Screw	4 Pcs
J	JCRC MX250	4 Pcs
K	L-KEY	1 Pcs

PACKED WITH MX2 MLBR042

## STEP 1

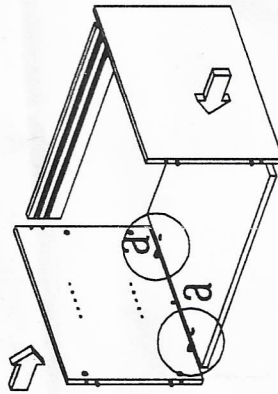

## STEP 2

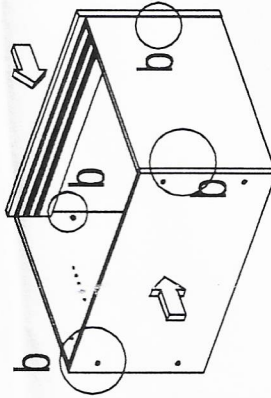

## STEP 3

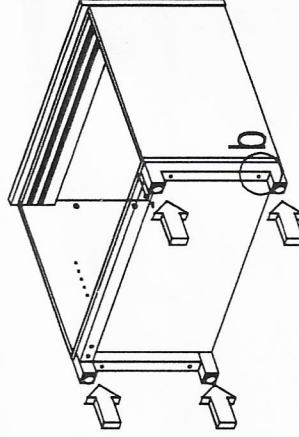

## STEP 4

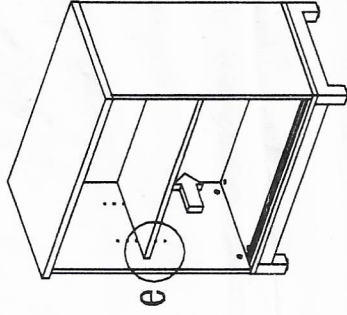

## STEP 5

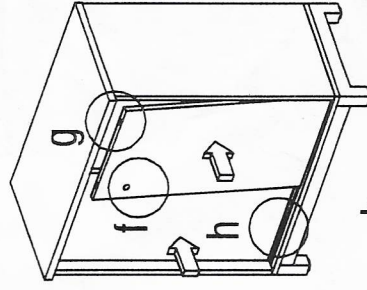

## a

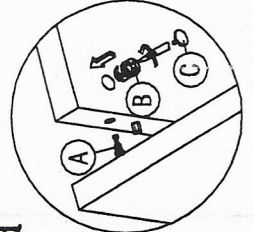

## b

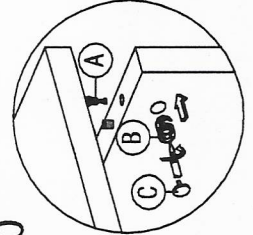

## c

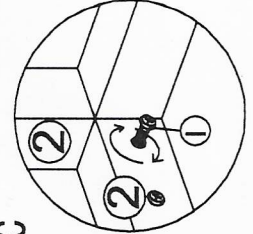

## d

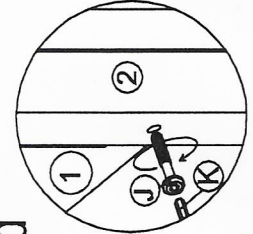

## e

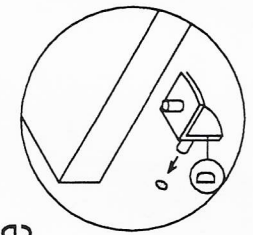

## f

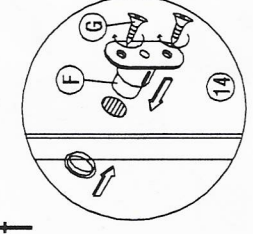

## g

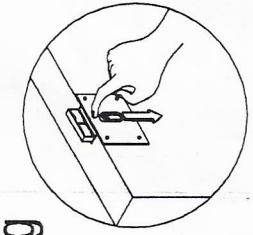

## h

