

# Ergoplan Bookcase 1800H

## Assembly Instructions

**Tools Required:** Powered Screwdriver



# Ergoplan Bookcase 1800H

## Assembly Instructions

- To prevent possible scratches or damage, assemble the product on a soft surface such as a blanket, carpet or packaging.

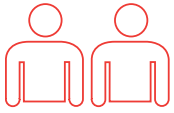

Recommended  
2-person Step

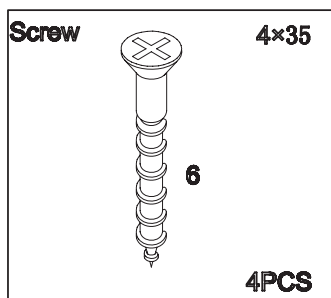
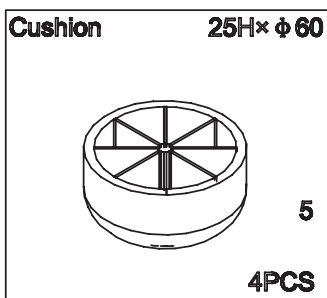
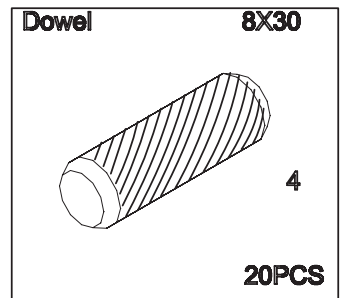
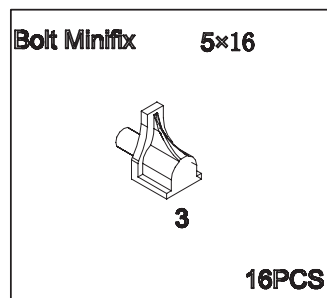
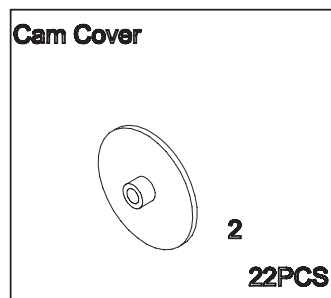
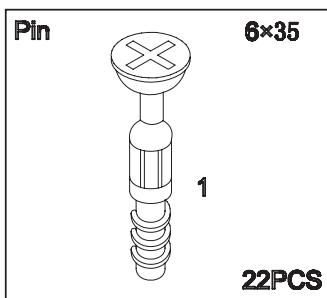
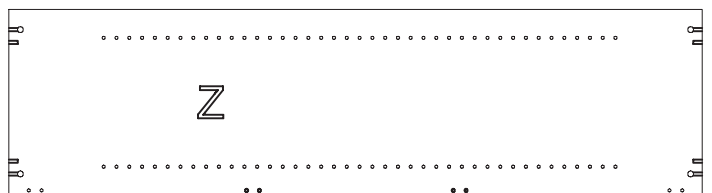
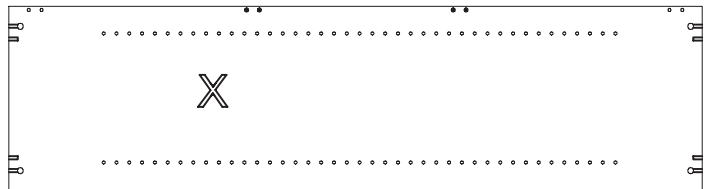
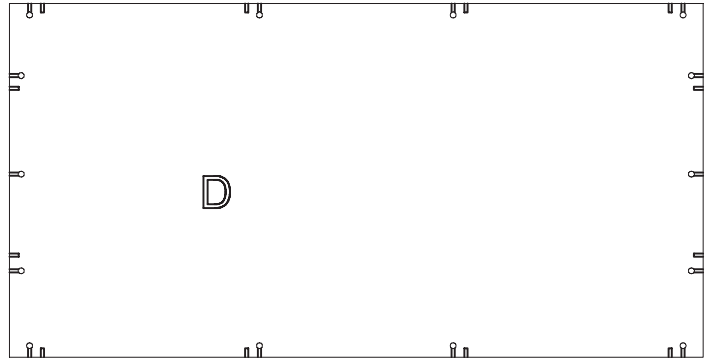
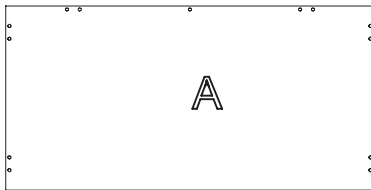
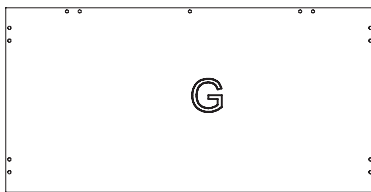
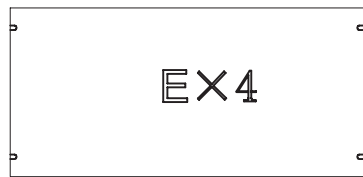

### Step 1

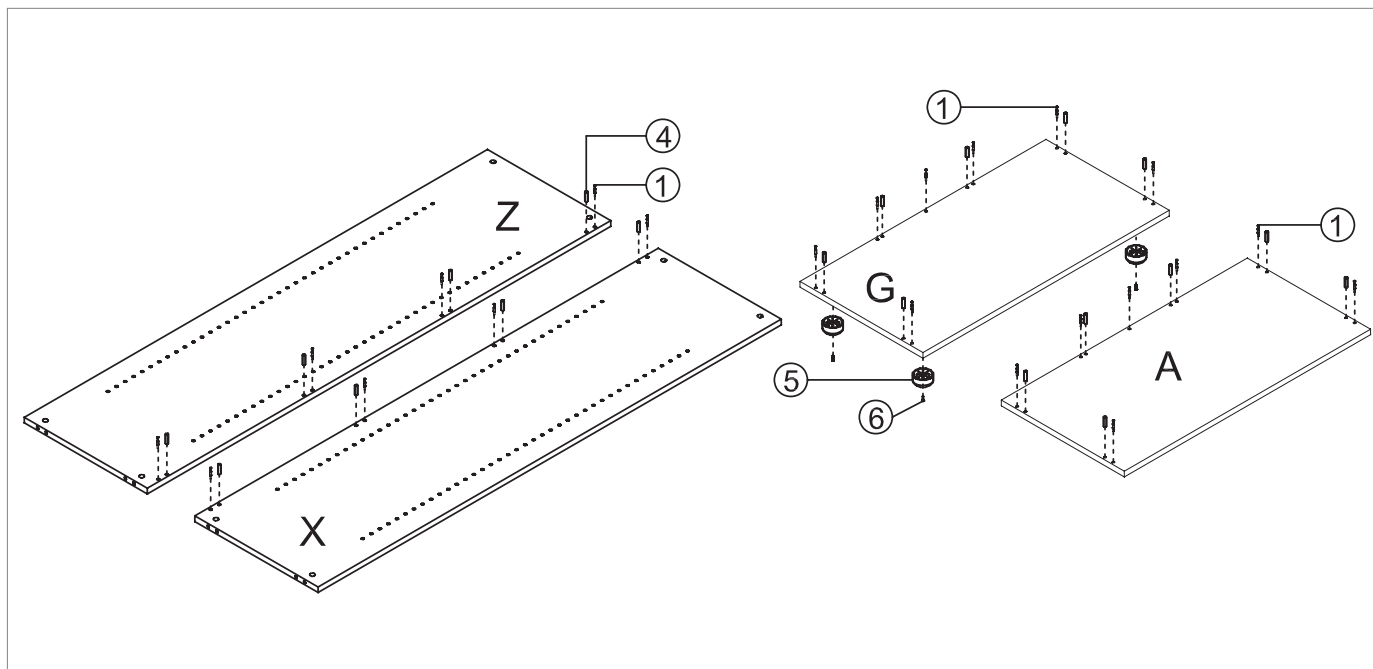

### Step 2

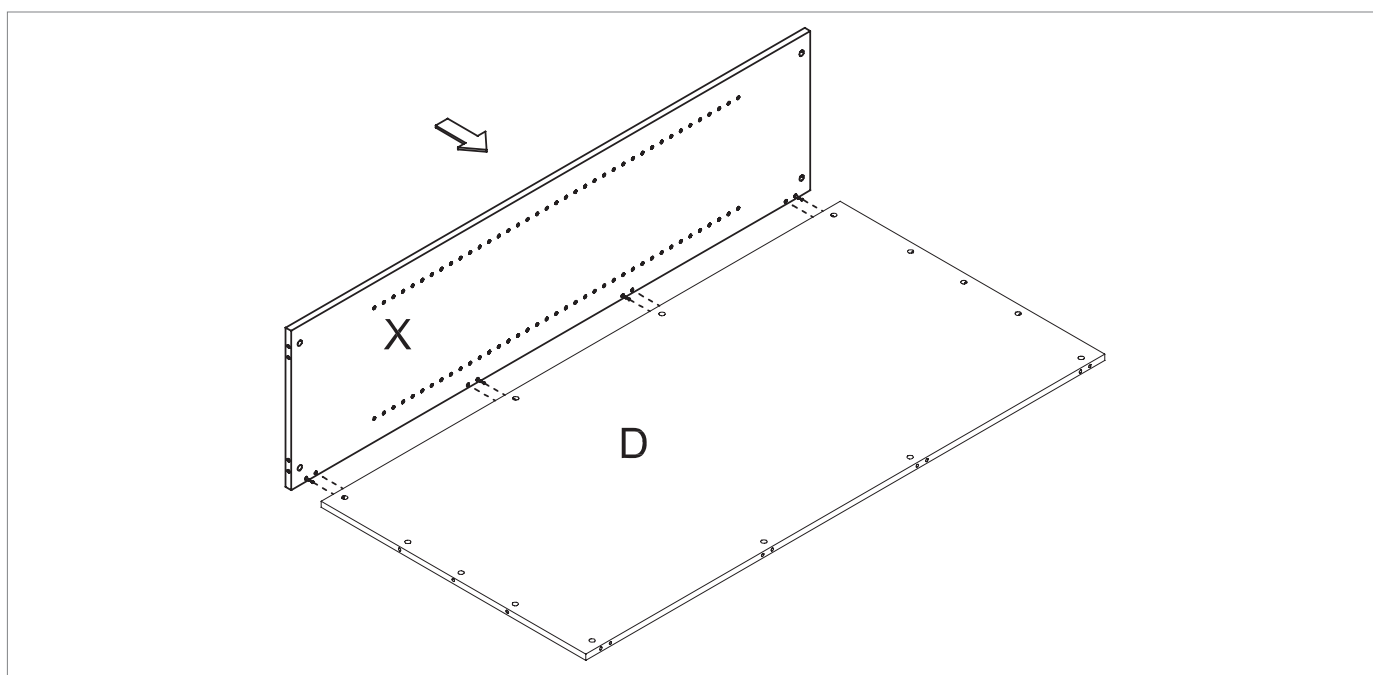

## Step 3

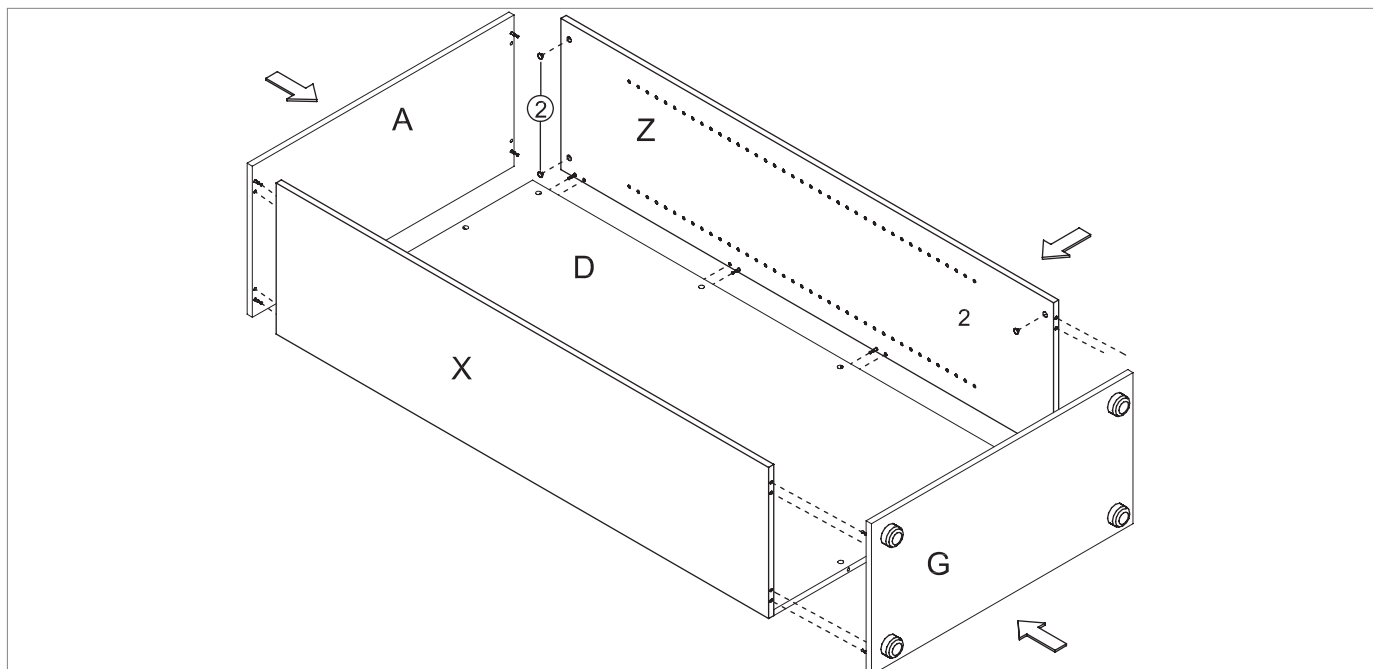

## Step 4

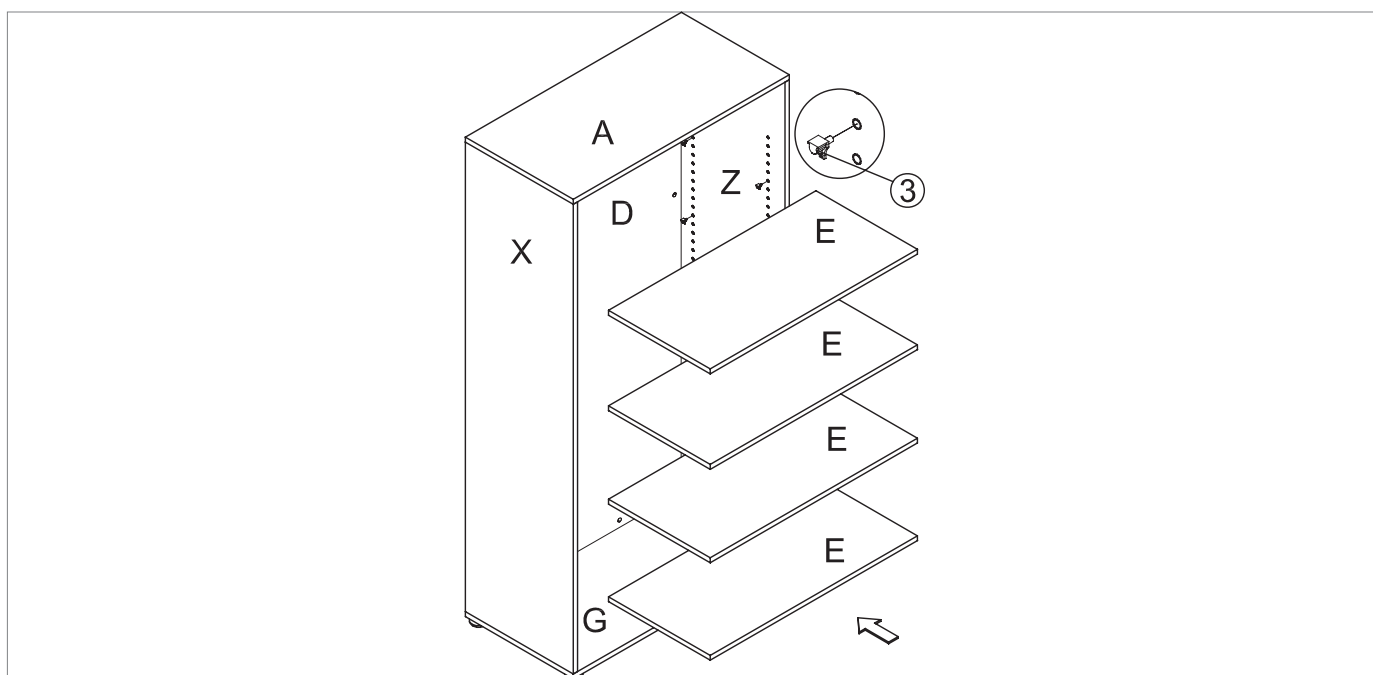

### Complete

---

