

# Ergoplan Boardroom Table

## Assembly Instructions

**Tools Required:** Powered Screwdriver



# Ergoplan Boardroom Table

## Assembly Instructions

- To prevent possible scratches or damage, assemble the desk upside down on a soft surface such as a blanket, carpet or packaging.
- Attach leg to the top assembly by using bolts, spring washer, flat washer. Tighten using the allen wrench.

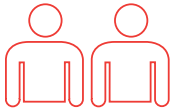

**Recommended  
2-person Step**

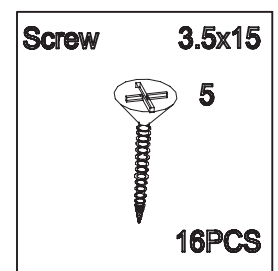
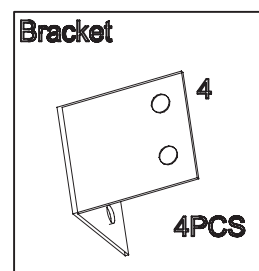
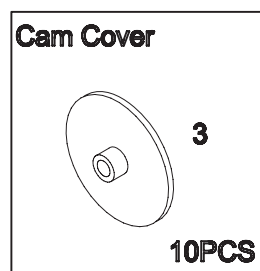
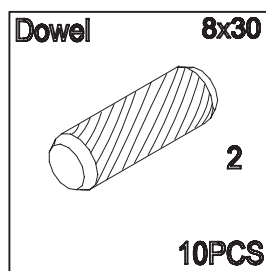
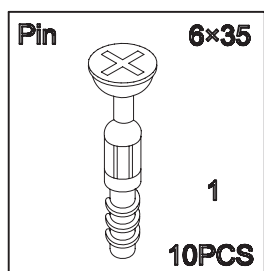
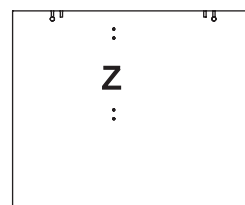
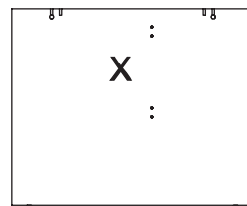
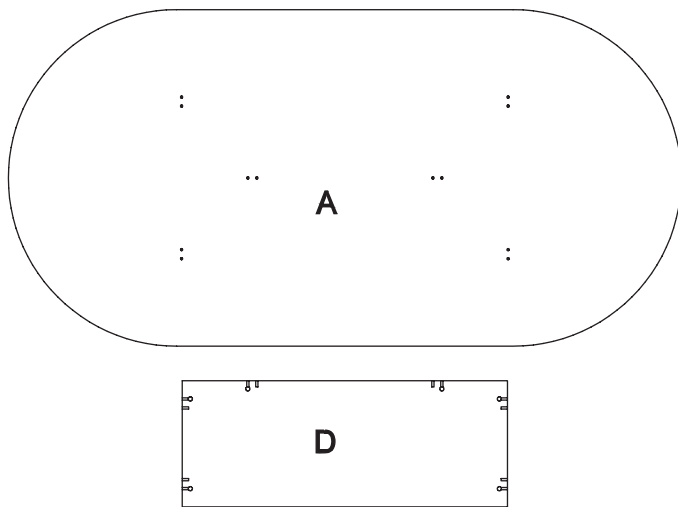
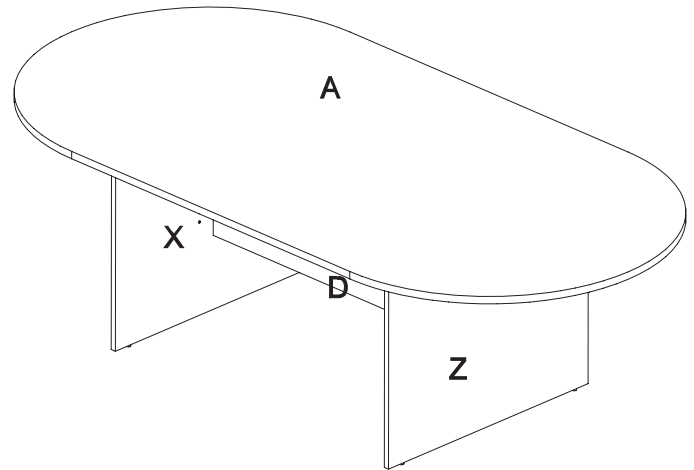

### Step 1

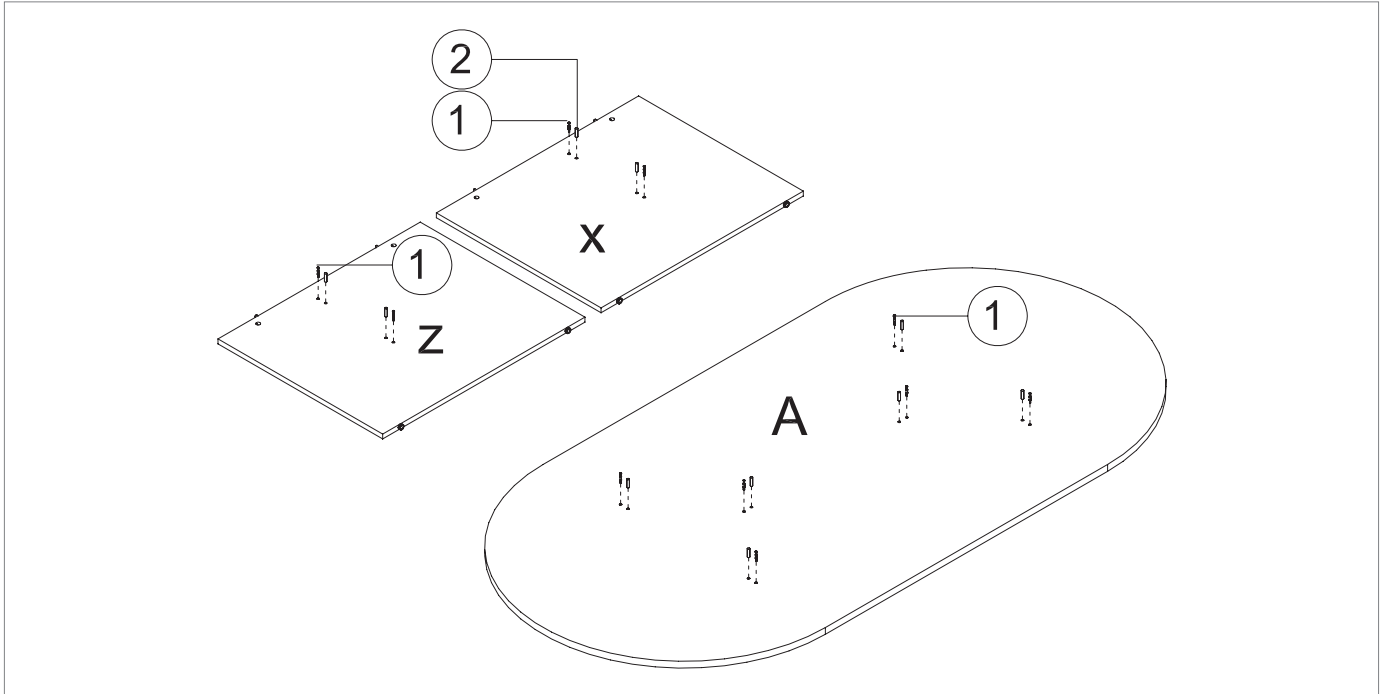

### Step 2

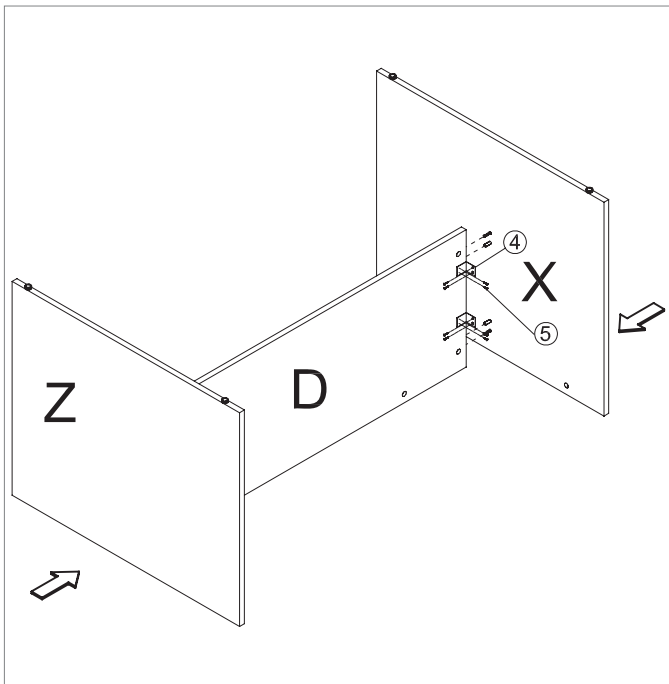

### Step 3

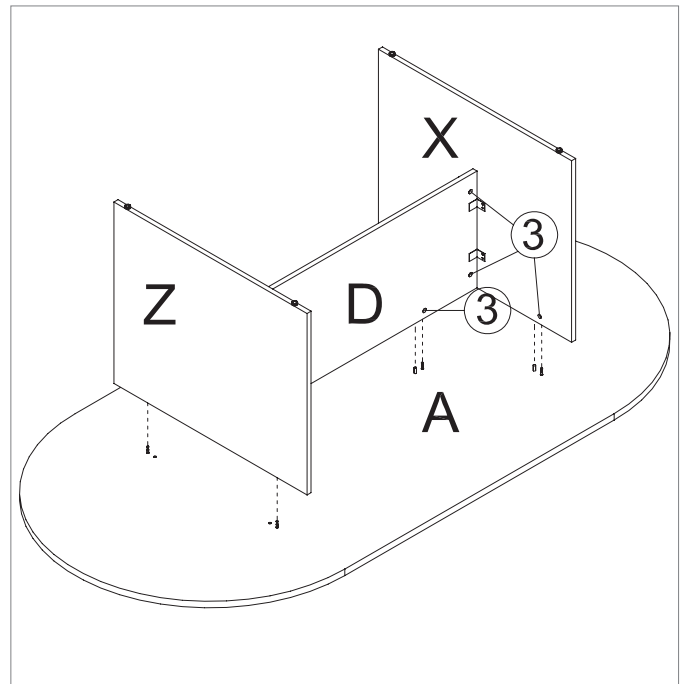

### Complete

---

