

EDWARDS & CO

Use + Care Guide

Stroller Board

For Oscar M and Olive strollers

EC214-104





IMPORTANT

- Keep these instructions for future reference.
- Always follow the manufacturer's instructions.
- Read all instructions carefully before assembly and use of this Stroller Board.
- The correct use and maintenance of this product is essential.
- Only use the Stroller Board when another child is in the main stroller seat.

Suitable for children up to 22kg

Contents

Warnings	4
What's in the box	5
Stroller Board components	6
Assembling the Stroller Board	7
Using the Stroller Board connectors	8
Attaching the connectors	8
Removing the connectors	11
Using the Stroller Board	12
Attaching the Stroller Board	12
Removing the Stroller Board	13
Storing the Stroller Board	14
Approved configurations	15
Olive	15
Oscar M	16
How to care for and maintain your Stroller Board	17
WARRANTY	19

Warnings



TO AVOID INJURY OR DEATH

NEVER leave child unattended on this product.

Stroller can tip if child attempts to hang from stroller handle.

Maximum weight limit **22kg**.

For use with approved Edwards & Co strollers only.

Cannot be used with Edwards & Co Otto stroller.

Intended for use with only one child at a time.

Always keep your hands on the stroller when your child is standing on the Stroller Board.

Make sure that your child is always standing with both feet on the Stroller Board and holding onto the handle bar to avoid any possible injury during use.

Check the Stroller Board is connected securely before each use.

DO NOT use if any part of the Stroller Board is loose, missing or broken.

Beware of children's feet and toes when pushing the board down from it's storage position.

What's in the box

Use + Care Guide
(this instruction
manual)

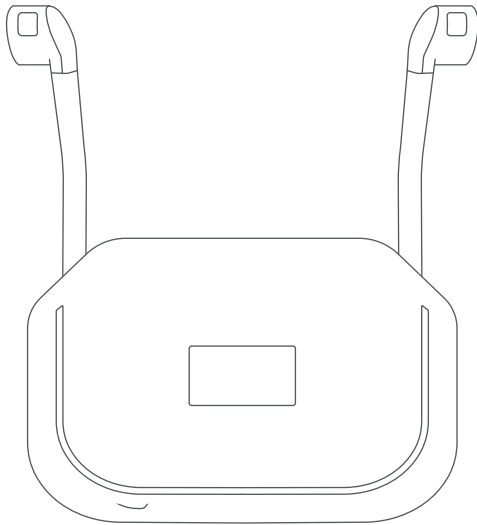

1 x Stroller Board

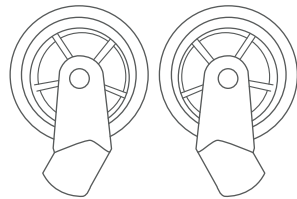

2 x Wheels

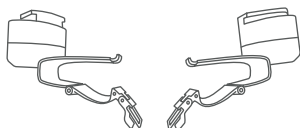

2 x Connection Clips
(Left & Right)

Stroller Board components

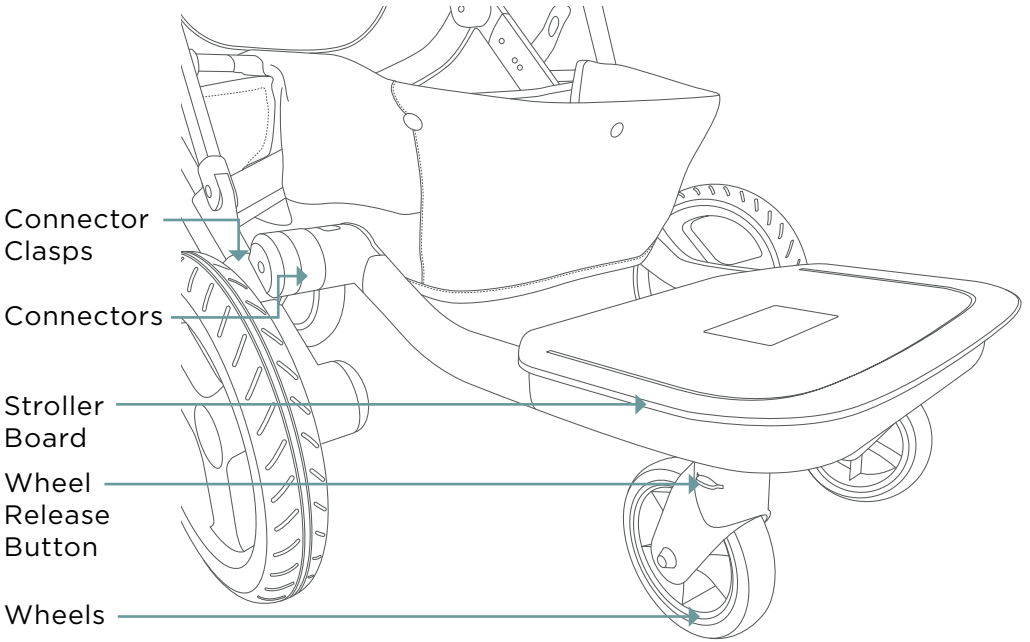

Assembling the Stroller Board

1. Turn the stroller board upside down and locate the metal wheel pins.

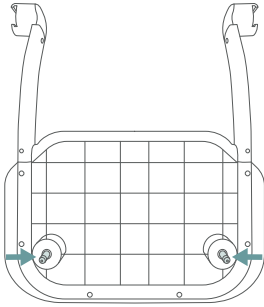

2. Position the wheel above the metal wheel pin on the stroller board.

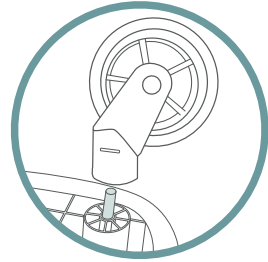

3. Push the metal release button on the wheel and simultaneously slide the wheel onto the metal wheel pin.

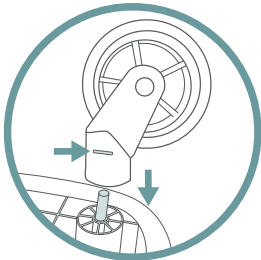

4. Release the metal wheel release button. Ensure the wheel is secure by pulling it upwards.

✓ You will hear a click when the wheel connects.

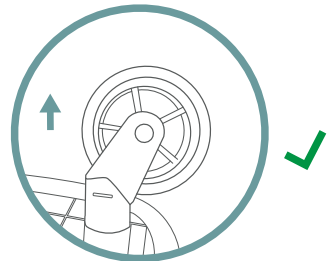

5. Repeat with the second wheel.

Using the Stroller Board connectors

Note: The stroller can be folded with the Stroller Board connectors in place.

Attaching the connectors

1. Remove the rear wheels from the stroller. Press the wheel release button in the centre of the rear wheel.
2. Pull the wheel outwards.

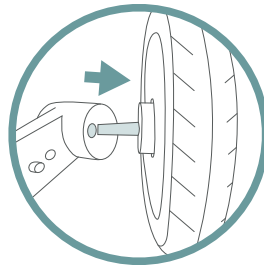
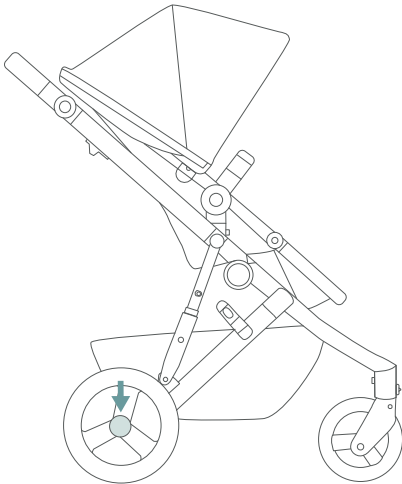

STROLLER BOARD - USE + CARE GUIDE

3. Slide the open connector into position on the lower part of the stroller frame (L = Left; R = Right).

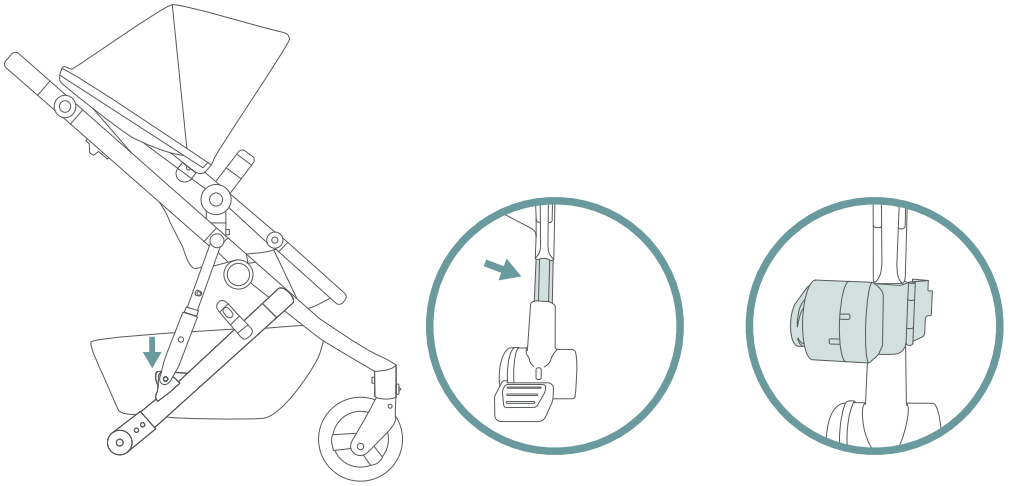

STROLLER BOARD - USE + CARE GUIDE

4. Close the plastic and metal clasp on the underside of the stroller frame.

Note: Ensure the brake cable is inside the channel on the clamp. If not fitted correctly, the cable may jam and interfere with the brake system.

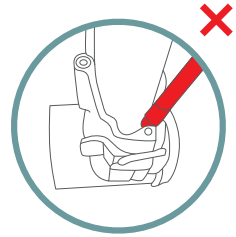
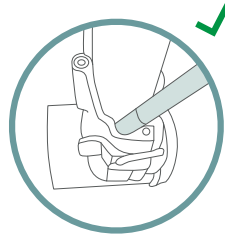
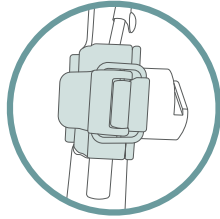
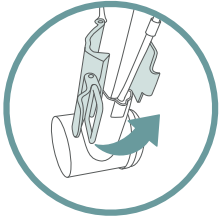

5. Repeat with the second connector. Once attached, reattach rear wheels on stroller.

Removing the connectors

1. Undo the connector's metal and plastic clasp on the underside of the stroller frame.

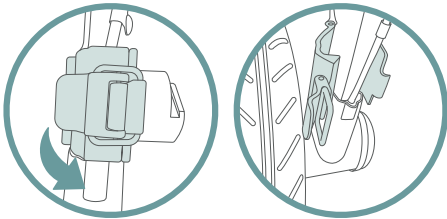

2. Remove the connector.

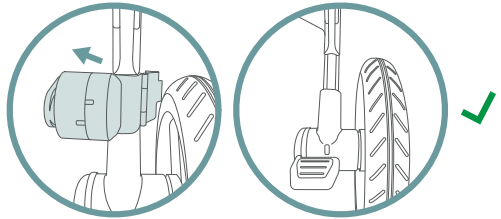

3. Repeat with the second connector.

Using the Stroller Board

Attaching the Stroller Board

1. Ensure the inner side of the connector on the stroller frame is in a vertical position. If necessary, twist it into position.

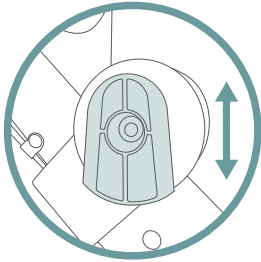

2. Position the arms of the Stroller Board above each of the connectors and slide them down into place.

✓ You will hear a click when the Stroller Board connects.

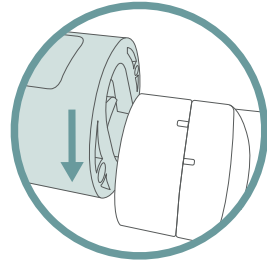

3. Pull upwards on the Stroller Board arms to ensure it is secure.

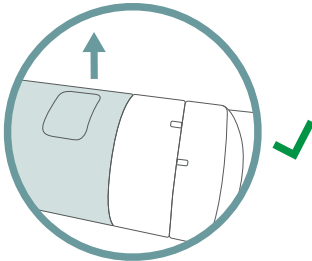

Removing the Stroller Board

1. Locate the Stroller Board release buttons on top of each arm, alongside the connection points.
2. Press both release buttons and simultaneously lift the Stroller Board arms upwards.

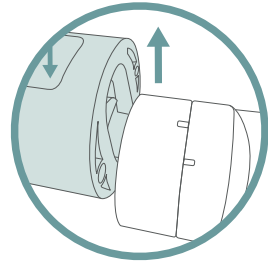
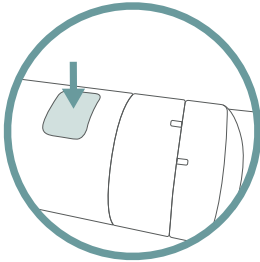

Storing the Stroller Board

Note: There are two storage positions for the Stroller Board. You may need to undo the Velcro and domes on the Oscar Mx to achieve this position.

Storage Position 1.

Lift the stroller board until it holds in storage position 1 after 1 click.

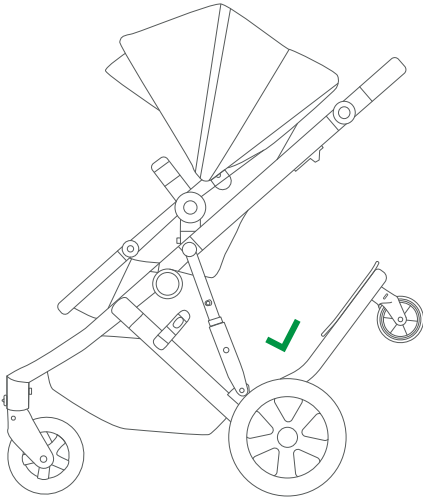

Storage Position 2.

Lift the stroller board until it holds in storage position 2 after 2 clicks.

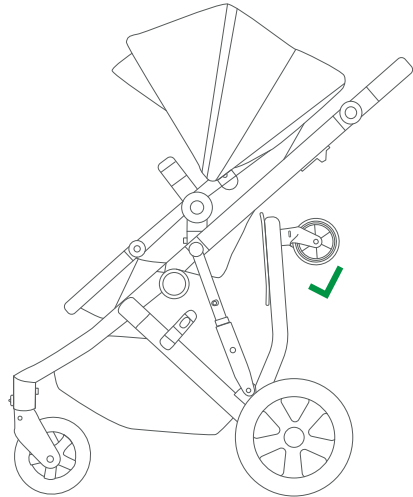

Note: When using storage position 2 on the Oscar M stroller, the Stroller Board will push the frame of the storage basket upwards.

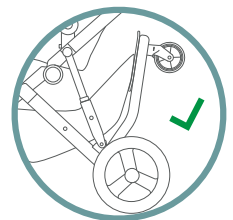

Approved configurations

Note: We advise Carry Cot 2, not Carry Cot Mx, for a better fit.

Olive

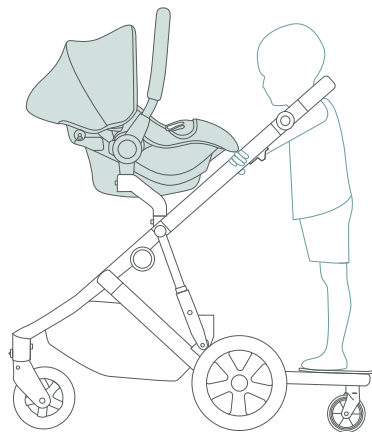
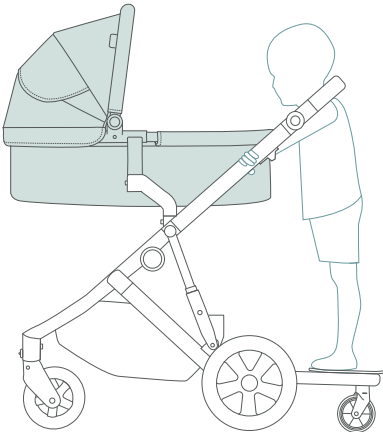
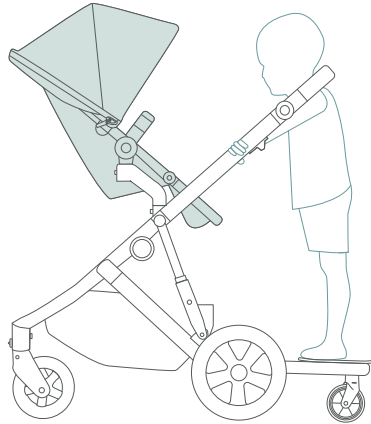
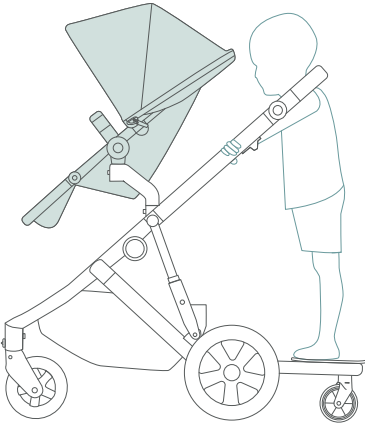

Oscar M

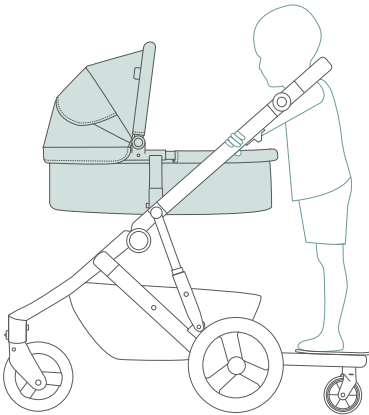
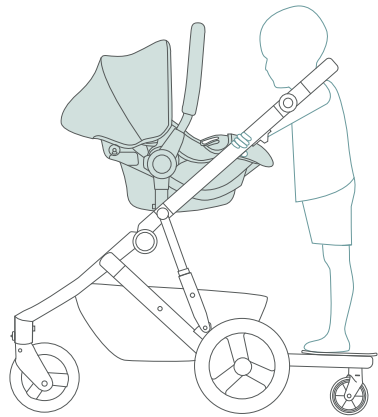
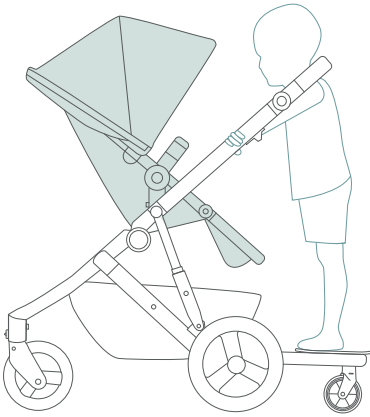

How to care for and maintain your Stroller Board

Store your Stroller Board carefully

Store inside in a well-ventilated, dry area.

Do not store in a damp environment that is not well insulated (such as an unfinished basement or outdoor shed).

Store when dry, not damp or wet.

Store away from direct sunlight.

Do not place heavy objects on top of your Stroller Board or accessories.

NEVER allow your Stroller Board to come into contact with corrosive substances. Examples are battery acid or petroleum products. Corrosion is not covered under our warranty - see the Warranty in this Instruction Manual.

Clean your Stroller Board carefully

NEVER clean any part of the Stroller Board with abrasive, ammonia-based, bleach-based or spirit-based cleaners.

Dry your Stroller Board carefully

Dry the Stroller Board thoroughly before storing it.

Check regularly for wear and tear

Check regularly for wear and tear on all Stroller Board parts.

Inspect your Stroller Board regularly

Inspect your Stroller Board regularly to maintain it. Regular inspection ensures the locking devices are working correctly and essential components are secure.

Do not use your Stroller Board on the beach

Do not use your Stroller Board on the beach. Salt and moisture can damage moving parts. Even salty atmospheric conditions can affect the Stroller Board's mechanisms.

If you live within 3kms of the sea, take extra care to park/store your Stroller Board indoors and away from wind. Salt water carries in strong winds and is extremely corrosive.

Warranty

All Edwards & Co products are guaranteed for two years from the date of shipping against defects in material and workmanship.

If we determine that the product has a manufacturing fault, we will repair or replace it free of charge to you. The decision to repair or replace is solely at the discretion of Edwards & Co Proof of purchase must be provided.

The warranty is “return to base” and not a free in-home service. This means the customer is responsible for any inwards freight charge to return the product to an Edwards & Co representative for warranty or service.

Our warranty excludes claims resulting from misuse, abnormal use, overloading, general wear and tear, child outgrowing the product, not following instructions, transportation damage (including airline or freight damage), poorly maintained product, dropped goods, negligence, second-hand product, modified product, colour fading, over inflation, mould, damage to handle foam in use or fabric cuts and tears. Our warranty also does not cover tyre punctures or corrosion to frames or fasteners as a result of atmospheric or environmental conditions.

Any replacement will not give the right for the warranty period to be extended.

Edwards & Co does not cover warranty if the product has been purchased second hand or from an unauthorised reseller.

For the complete terms and conditions of our warranty, please visit our website — edwardsandco.nz/pages/warranty

Edwards & Co New Zealand

Unit 5
30 Foundry Road
Silverdale 0932
NEW ZEALAND

NZ: (09) 869 8950

hello@edwardsandcobaby.com

Edwards & Co Australia

C/O - G&S Logistics
Unit 1, 96-112 Gow Street
Padstow NSW 2211
AUSTRALIA

AU: (02) 9066 6702

Designed with love

Watch helpful
instructional videos



Come along
on the journey

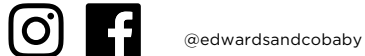

Visit our comprehensive support centre online

edwardsandcobaby.zendesk.com/hc/en-us