

EDWARDS & CO

Use + Care Guide

---

# Carry Cot

EC201-104



NZ AU



## **IMPORTANT**

- Keep these instructions for future reference.
- Always follow the manufacturer's instructions.
- Read all instructions carefully before assembly and use of this Carry Cot.
- The correct use and maintenance of this product is essential.

Suitable for children 0 to 9kg

Independently safety tested for compliance with the European safety standard EN1466:2014

# Contents

---

<b>Warnings</b>	<b>4</b>
<b>What's in the box</b>	<b>6</b>
<b>Carry Cot components</b>	<b>7</b>
<b>Assembling the Carry Cot</b>	<b>8</b>
<b>Collapsing the Carry Cot</b>	<b>10</b>
<b>Attaching the sunshade</b>	<b>12</b>
<b>Removing the canopy fabric</b>	<b>14</b>
<b>Attaching the Carry Cot to the stroller frame</b>	<b>15</b>
<b>Removing the Carry Cot from the stroller frame</b>	<b>16</b>
<b>How to care for and maintain your Carry Cot</b>	<b>17</b>
<b>WARRANTY</b>	<b>19</b>

## Warnings

---



### TO AVOID INJURY OR DEATH

#### Maximum limits

The maximum weight of the child using this Carry Cot/bassinet attachment is **9kg**.

This product is only suitable for a child who cannot sit up unaided.

#### Approved locations of use

This Carry Cot should only be clicked securely into approved Edwards & Co strollers or an approved Edwards & Co Carry Cot Stand.

This Carry Cot is only suitable for use with Edwards & Co Oscar M series and Olive strollers.

Only use this Carry Cot on a firm, horizontal, level and dry surface.

When using inside, always have the Carry Cot canopy open, the sunshade and apron off, with underneath vent holes open.

#### Safe use of the Carry Cot around children

Do not let other children play unattended near the Carry Cot.

Make sure children are clear of any moving parts when adjusting the Carry Cot otherwise they may be injured.

This Carry Cot is suitable for one child only. Do not carry extra children or bags in the Carry Cot.

## **Safe use & care of the Carry Cot**

Before carrying or lifting the Carry Cot, ensure the handle is in the upright position for use.

When installing the Carry Cot in an approved Edwards & Co stroller, ensure the stroller's parking brake is engaged at all times.

Do not place heavy weights on the Carry Cot handle.

Do not use if any part of the Carry Cot is broken, torn or missing.

Ensure the Carry Cot mattress is installed flat without any curls at the edges.

Never add another mattress on top of the mattress provided by Edwards & Co with the Carry Cot.

Only use replacement parts supplied or approved by Edwards & Co.

Do not place any toys or obstructions in the Carry Cot.

The handles and the bottom of the Carry Cot should be inspected regularly for signs of damage and wear.

## **Keeping the Carry Cot away from fire and extreme heat**

Do not place or store the Carry Cot near an open fire or other source of high heat. Examples are a roof space, or beside shed walls that can get hot.

# What's in the box

---

Use + Care Guide  
(this instruction  
manual)



1 x Sun Visor

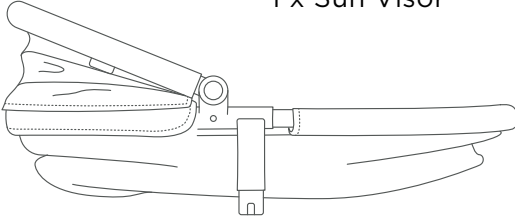

1 x Carry Cot Frame

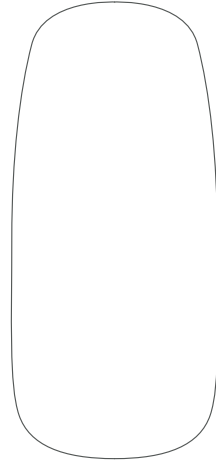

1 x Carry Cot Mattress

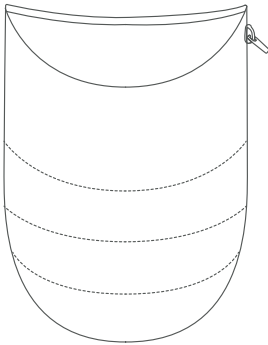

1 x Carry Cot Apron

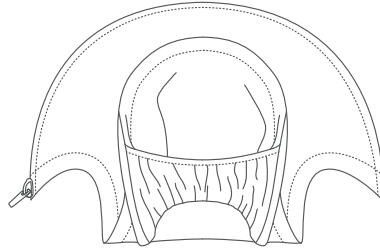

1 x Carry Cot Sunshade

# Carry Cot components

---

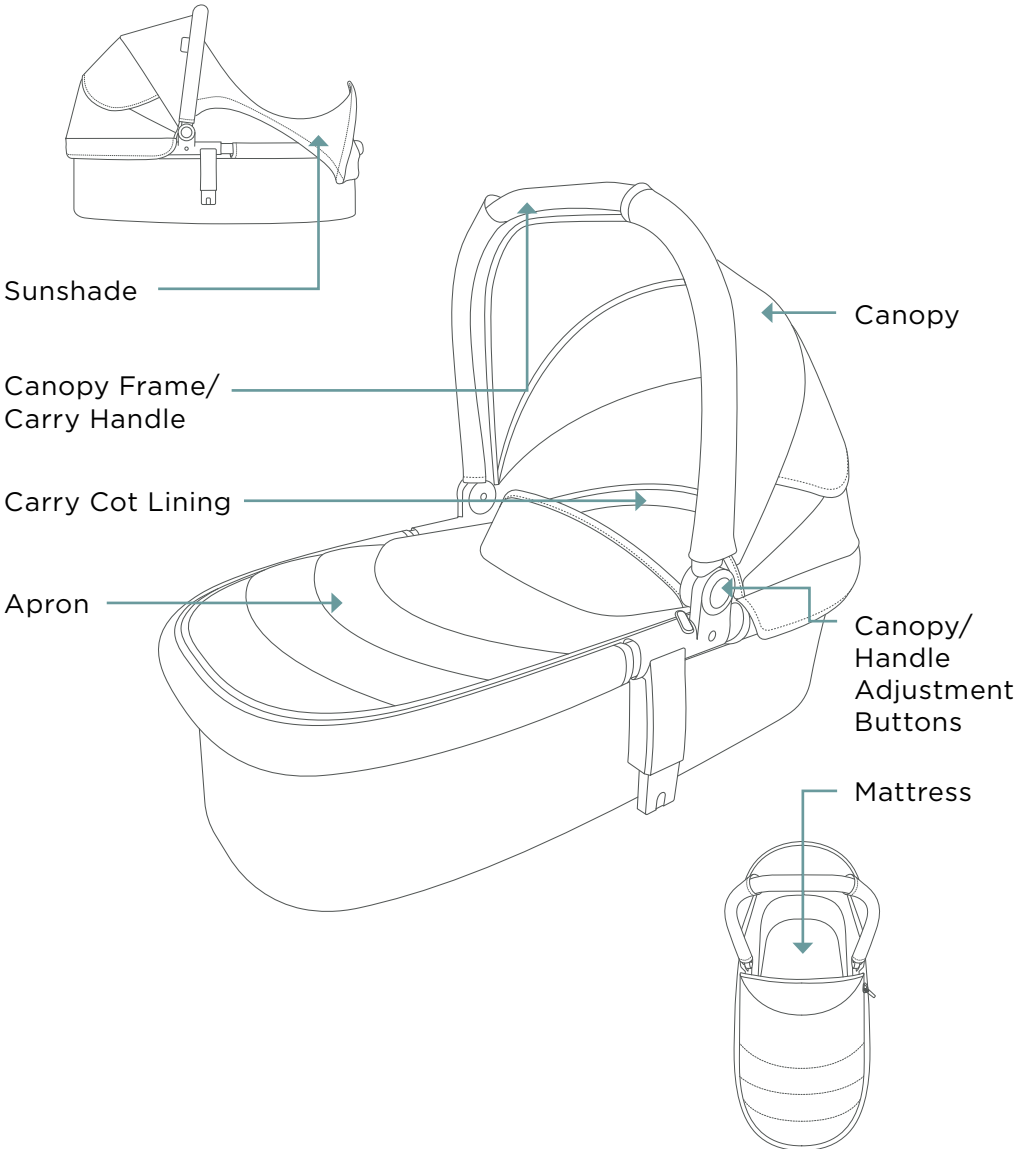

# Assembling the Carry Cot

1. Remove the mattress and unzip the lining from the inner wall of the Carry Cot.

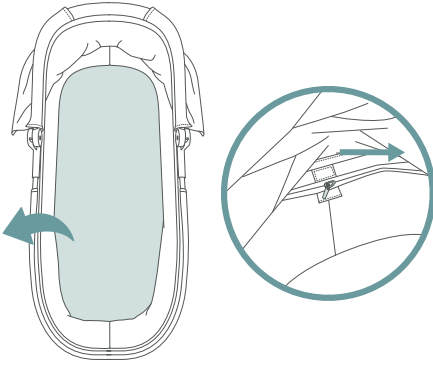

2. Locate the two black metal bars on top of the wooden base inside the Carry Cot.

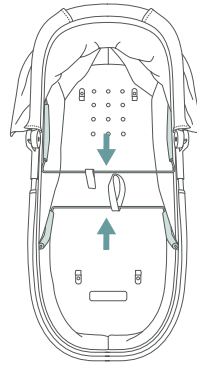

3. Pull the strap attached to one bar and secure the bar in its housing attached to the wooden base. Repeat this with the second bar in the opposite direction.

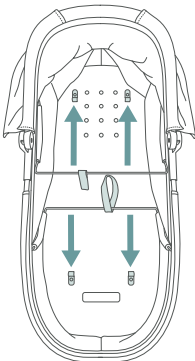

4. The Carry Cot sides should now be rigid.

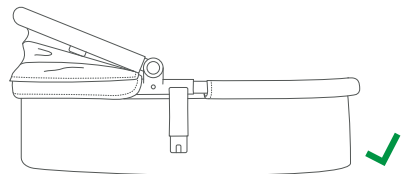



5. Zip the lining back into place and place the mattress inside the Carry Cot ensuring it is flat and snug.

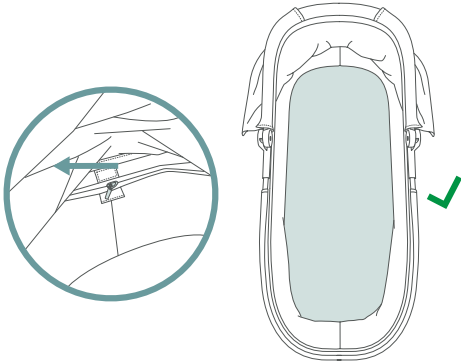

6. Locate the canopy/handle adjustment button on each of the canopy hinges. Raise the canopy by pressing the buttons simultaneously and lift the canopy upwards.

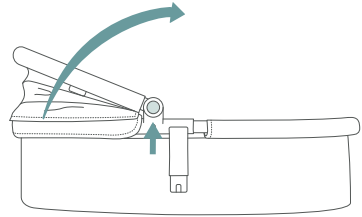

7. Zip the apron on to the Carry Cot

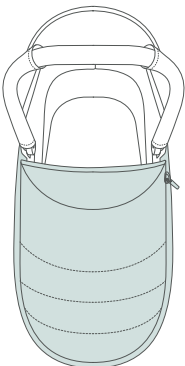

8. Zip the sun visor on to the canopy using the front (shorter) zipper track.

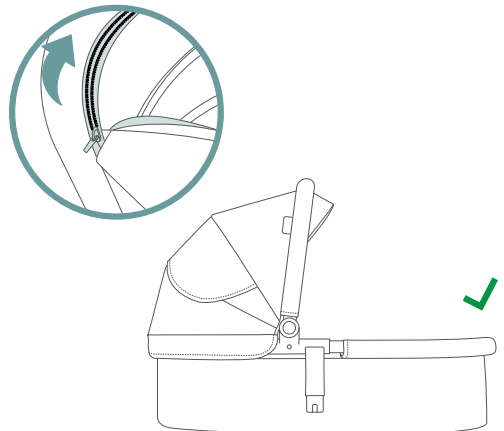

# Collapsing the Carry Cot

---

1. If necessary, remove the sunshade and apron.

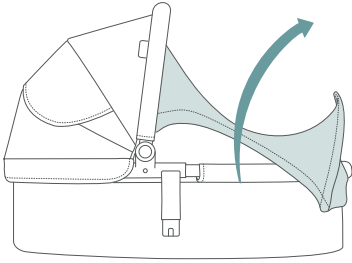

2. Fold the canopy down to a flat position.

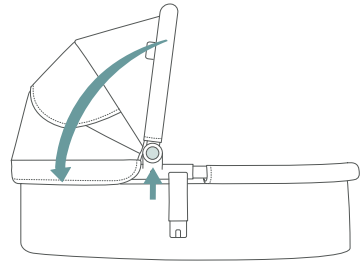

3. Remove the mattress and unzip and remove the lining from inside the Carry Cot.

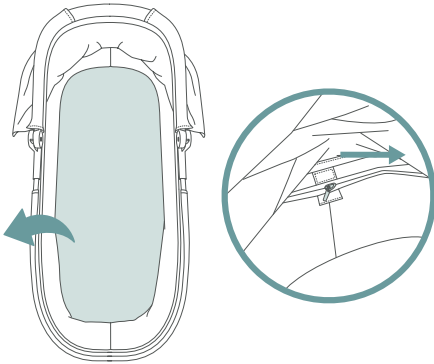

4. Locate the two black metal bars on top of the wooden base inside the Carry Cot.

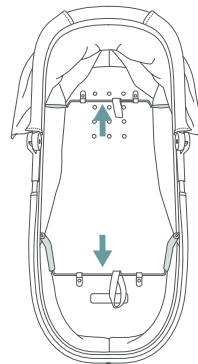

- 5.** Pull the strap attached to one bar to release it from its housing. Repeat this with the second bar.

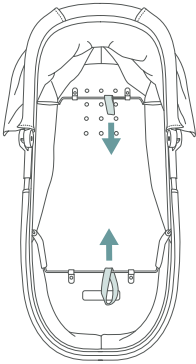

- 6.** The Carry Cot sides can now be collapsed.

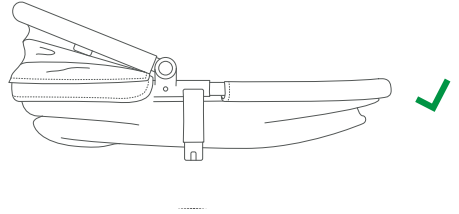

# Attaching the sunshade

---

**Note:** The sunshade can be attached behind the sun visor.

**Note:** To connect the sunshade, ensure the Carry Cot's canopy is fully extended. The sunshade can be easily stowed above the canopy when not in use, or when removing baby.

---

1. Locate the start of the zip on the sunshade behind the zip of the sun visor. Locate the zip connector inside the bottom left side of the Carry Cot's extended canopy (**don't confuse this zip with the zip to remove the canopy fabric**). Connect the zip at this point.

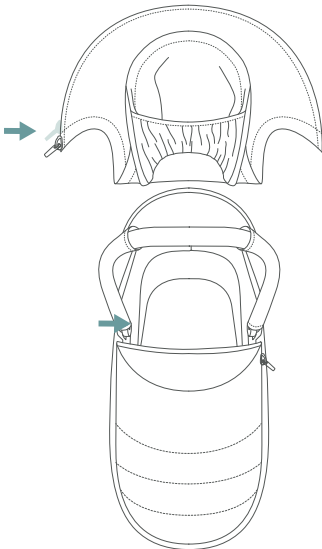

2. Zip the sunshade to the canopy.

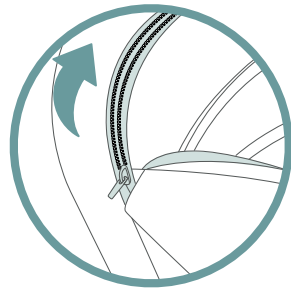

- 3.** Stretch the sunshade over the length of the Carry Cot and secure it by extending it over the Carry Cot's end.

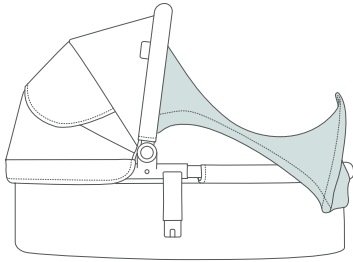

## Removing the canopy fabric

---

**Note:** The canopy may need to be removed for the purpose of cleaning. To remove the canopy fabric, ensure the Carry Cot's canopy is fully extended.

---

1. Locate the zips connecting the canopy fabric on each inner side of the Carry Cot's extended canopy (**don't confuse the zip on the left hand side with the zip for the sunshade**).

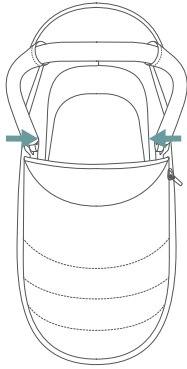

2. Unzip each side.

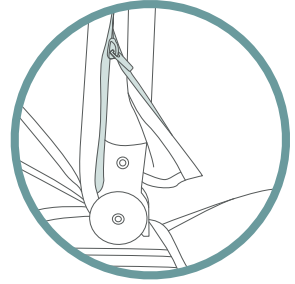

3. Remove canopy fabric.

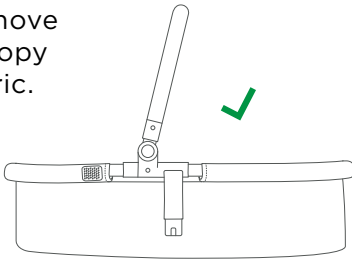

# Attaching the Carry Cot to the stroller frame

---

**Important:** The Edwards & Co Carry Cot can only be used with approved Edwards & Co strollers. Do not use with other brand strollers.

**Warning:** Do not use the Carry Cot when baby can sit up unaided or when their weight exceeds 9kg, whichever is sooner.

---

1. Insert the Carry Cot's connectors into the connection points on the stroller frame. Pull the Carry Cot upwards to check it is secure.

✓ You will hear a click when the Carry Cot connects correctly.

**Recommendation:** Install the Carry Cot in the reverse position (with your baby looking at you).

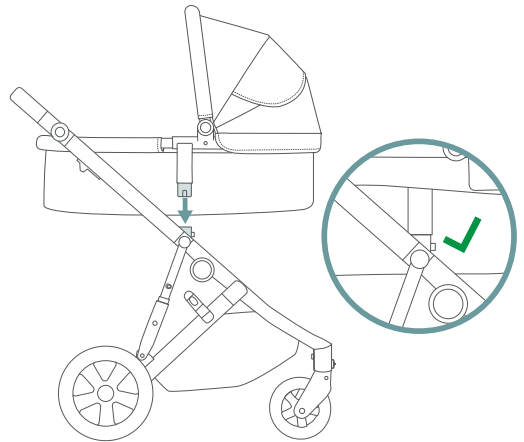

# Removing the Carry Cot from the stroller frame

1. Locate the two Carry Cot release buttons on the stroller frame, just below the Carry Cot's connection points.

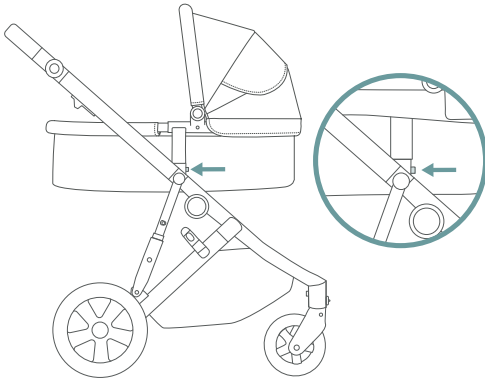

2. Push in one release button until it stays in place.

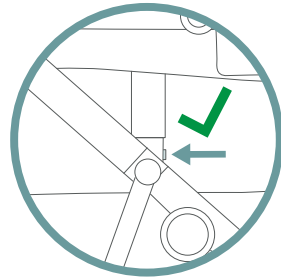

3. Push in the release button on the other side until it stays in place.

**Note:** The buttons do not need to be pressed simultaneously.

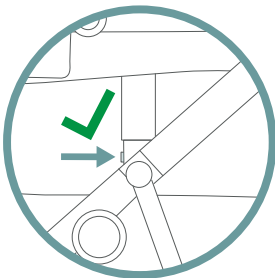

4. Lift the Carry Cot straight up.

**Note:** Do not lift the Carry Cot on an angle.

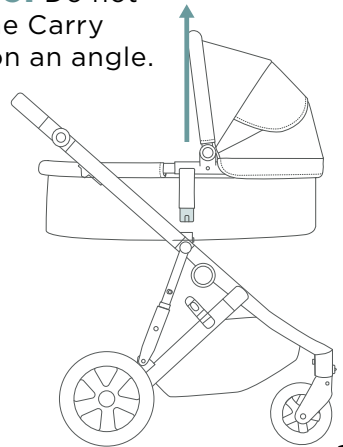



# How to care for and maintain your Carry Cot

---

## **Store your Carry Cot and accessories carefully**

Store inside in a well-ventilated, dry area.

Do not store in a damp environment that is not well insulated (such as an unfinished basement or outdoor shed).

Store when dry, not damp or wet.

Store away from direct sunlight. Direct sunlight could cause fabric fading or damage.

Do not place heavy objects on top of your Carry Cot or accessories.

**NEVER** allow your Carry Cot to come into contact with corrosive substances. Examples are battery acid or petroleum products. Corrosion is not covered under our warranty - see the **Warranty** in this Instruction Manual.

## **Clean your Carry Cot carefully**

Use a damp cloth to clean the canopy and outer material. To dampen a cloth, dip the cloth in a small amount of mild detergent diluted in water (such as laundry liquid).

**NEVER** fully soak the cloth in water.

**NEVER** get the mattress inner foam wet. If this gets wet, replace the mattress with an approved Edwards & Co mattress only. Available to purchase online from Edwards & Co.

To clean the mattress lining or Carry Cot lining, we recommend a warm wash (30 degrees) in a normal wash (for front loaders) or gentle wash (for top loaders).

**NEVER** clean any part of the Carry Cot with abrasive, ammonia-based, bleach-based or spirit-based cleaners.

See care labels for specific instructions regarding machine washing.

## **Dry your Carry Cot carefully**

Dry the Carry Cot thoroughly before storing it.

**NEVER** tumble dry any part of the Carry Cot.

**NEVER** wring any Carry Cot fabrics.

## **Check regularly for wear and tear**

Check regularly for wear and tear on all Carry Cot parts.

## **Inspect your Carry Cot regularly**

Get your Carry Cot inspected regularly to maintain it. Regular inspection ensures the locking devices are working correctly and essential components are secure.

## **Use your Carry Cot in sunlight for short periods**

Always store your Carry Cot in a shaded area. Only use your Carry Cot in direct sunlight for short periods. This will help reduce fabric fading and damage.

## **Read our Servicing Guide before using the Carry Cot on the beach or near salt water**

If you live within 3kms of the sea, take extra care to park/store your Carry Cot indoors and away from wind. Salt water carries in strong winds and is extremely corrosive.

Do not use your Carry Cot on the beach. Salt and moisture can damage moving parts. Even salty atmospheric conditions can affect the Carry Cot's mechanisms.

# Warranty

---

All Edwards & Co products are guaranteed for two years from the date of shipping against defects in material and workmanship.

If we determine that the product has a manufacturing fault, we will repair or replace it free of charge to you. The decision to repair or replace is solely at the discretion of Edwards & Co. Proof of purchase must be provided.

The warranty is “return to base” and not a free in-home service. This means the customer is responsible for any inwards freight charge to return the product to an Edwards & Co representative for warranty or service.

Our warranty excludes claims resulting from misuse, abnormal use, overloading, general wear and tear, child outgrowing the product, not following instructions, transportation damage (including airline or freight damage), poorly maintained product, dropped goods, negligence, second-hand product, modified product, colour fading, over inflation, mould, damage to handle foam in use or fabric cuts and tears. Our warranty also does not cover tyre punctures or corrosion to frames or fasteners as a result of atmospheric or environmental conditions.

Any replacement will not give the right for the warranty period to be extended.

Edwards & Co does not cover warranty if the product has been purchased second hand or from an unauthorised reseller.

For the complete terms and conditions of our warranty, please visit our website — [edwardsandco.nz/pages/warranty](http://edwardsandco.nz/pages/warranty)

## **Edwards & Co New Zealand**

Unit 5  
30 Foundry Road  
Silverdale 0932  
NEW ZEALAND

NZ: (09) 869 8950

[hello@edwardsandcobaby.com](mailto:hello@edwardsandcobaby.com)

## **Edwards & Co Australia**

C/O - G&S Logistics  
Unit 1, 96-112 Gow Street  
Padstow NSW 2211  
AUSTRALIA

AU: (02) 9066 6702

# Designed with love

Watch helpful  
instructional videos



Come along  
on the journey



---

Visit our comprehensive support centre online

**[edwardsandcobaby.zendesk.com/hc/en-us](https://edwardsandcobaby.zendesk.com/hc/en-us)**