

I K A W A



Pro Series

Improve Coffee, Farm to Cup

Our app-controlled sample roasters make consistent sample roasting easy.

They improve quality, save time, and encourage collaboration through profile sharing.

Our goal is to connect the coffee world, make roasting more accessible, and increase knowledge and understanding within the industry.

All this to say—we want to improve coffee, farm to cup.

Connect
the coffee
world.

FARM

CUP

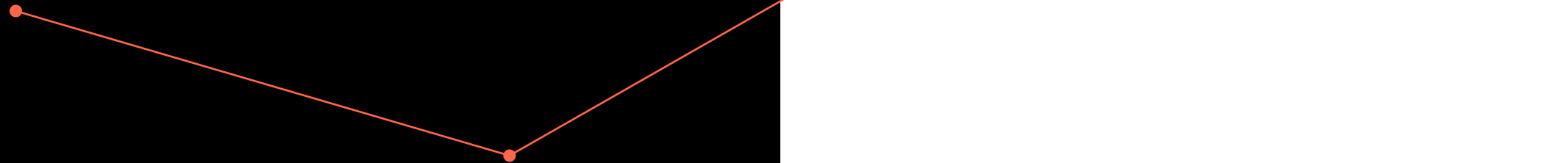

Introducing the IKAWA Pro Series

PRO50

PRO100



No matter the
business, there is
an IKAWA Pro
Sample Roaster
that fits.

The IKAWA Pro Series includes the Pro50 and Pro100; two models of our latest generation of sample roaster that give you the capability to elevate your sample roasting. Available in two different batch sizes, you will soon begin to benefit from its simplicity, consistency, repeatability, portability, connectivity, and reliability. Everything you need to make confident buying decisions and take your business to the next level.

Exhaust Sensor Roast Profiles in the IKAWA Pro App are compatible between all IKAWA Sample Roasters at the recommended batch sizes.

Pro50 Batch Size:



Capacity: 60g
Recommended: 50g



Pro100 Batch Size:



Capacity: 120g
Recommended: 100g



What Our Customers Love



Incredibly simple to operate.



Plug-n-Play

Achieve incredible roast quality at the touch of a button.



Hands-Free

Save time and money with automated roasting.

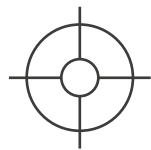

No Guesswork

Create and repeat world-leading roasts with digital accuracy.



Shareable

Get connected to our Roast Library and your new coffee community.

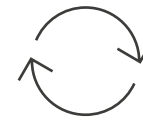

Trusted Partner

Produce 60+ precision roasts a day—year in and year out.



Travel-Ready

Set up shop anywhere you go—in a matter of seconds.

How It Works

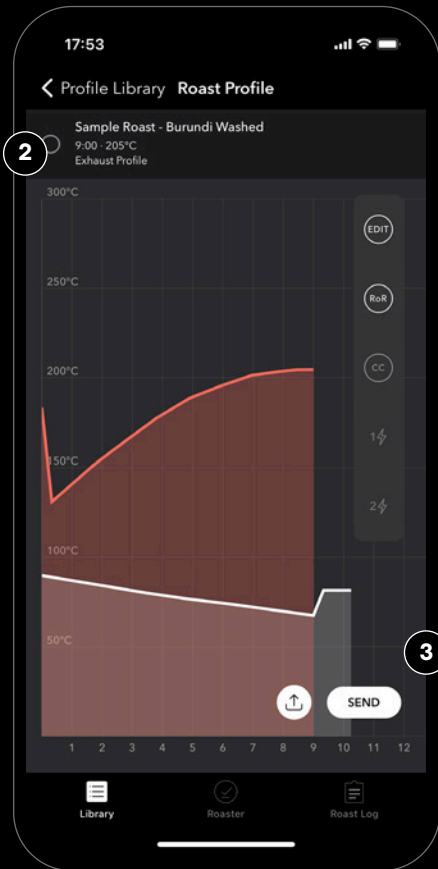

1

In 5 Steps

1. Connect your phone or tablet to the roaster (via Bluetooth).
2. Adapt or download the profile you need.
3. Press SEND to send to roaster.
4. Press the start button on the roaster.
5. Add your green coffee and twist the doser.

Sit back and let your IKAWA Pro do the rest.

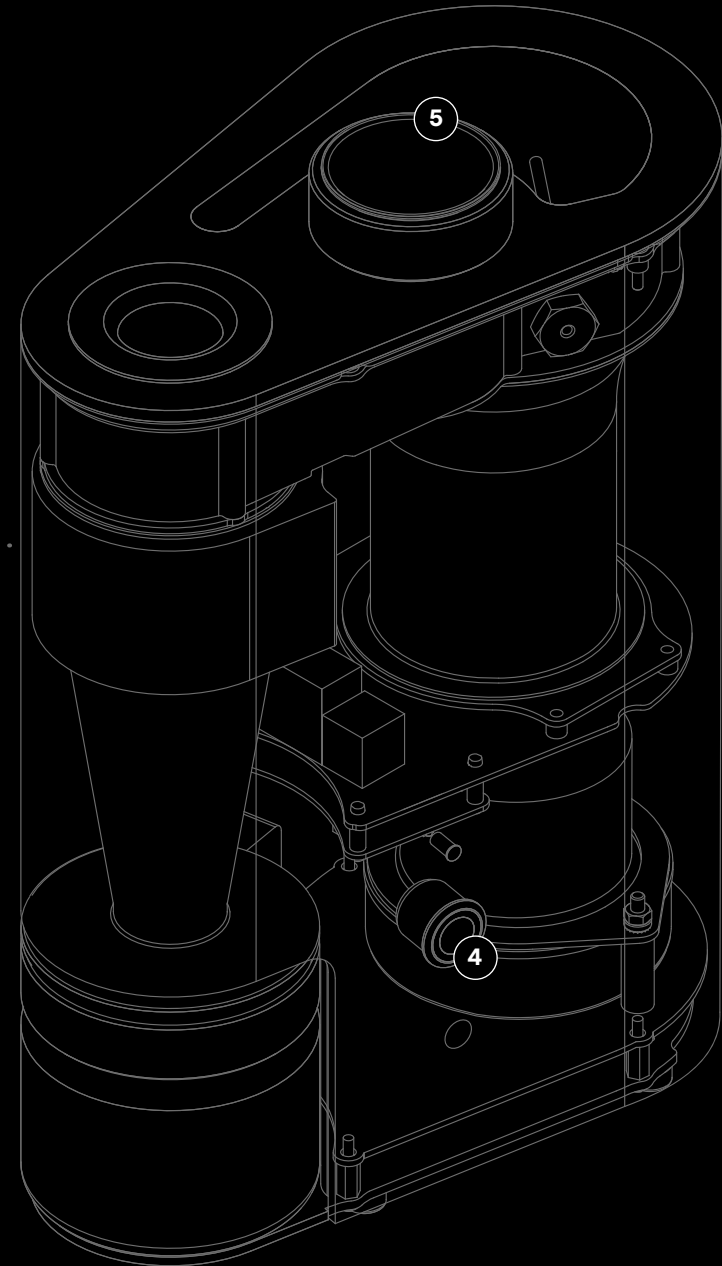

“The IKAWA gives us a 3D view of the raw material. There is no hiding—it gives us full transparency of the coffee.”

TOM FLAWITH

Head of Roasting
Square Mile Coffee, London

“The IKAWA is a game changer for our industry when it comes to sample roasting. It is changing the very way that we think about sample roasting. To begin with, it is portable, which most sample roasting equipment is not. It is easy to use, well-designed, and attractive. What I am most impressed by is the amazing degree of control and precision this roaster exhibits. It will accomplish what you program it to accomplish—dependably, accurately, and repeatedly.”

DREW BILLUPS

Director of Education & Quality Control
Atlas Coffee Importers, Seattle

“The IKAWA ProV3 is the most essential part of our sourcing program. It helps us be nimble in our purchasing, and to be able to share feedback on coffee with the same roast profile, at origin or in our lab.”

KYLE RAMAGE

Black & White Coffee
2017 US Barista Champion

“IKAWA Sample Roaster is a fantastic addition to our roastery. With set origin profiles we manage to achieve great consistency across our sample roasting. In terms of workflow it is very helpful to use the IKAWA as a desktop item while we continue our office work.”

RALF RÜLLER

Owner & Roaster
The Barn, Germany

“This thing is seriously impressive! The turnaround time, the repeatability. The way you can adjust the parameters. Definitely the best investment we’ve made so far.”

TALOR BROWNE

Owner
Talormade, Oslo

“It has made roasting through so many samples during buying season so much easier. I really enjoy the simplicity and shareability of roast profiles. I would absolutely recommend it.”

NAIDA LINDBERG

Assistant Buying & Logistics Coordinator
Verve Coffee Roasters, California

“The IKAWA Pro Sample Roaster has been an indispensable tool in order to repeat the exact roast profile on different coffee samples used for evaluation.”

IDA STEEN

Sensory Researcher & Scientist
University of Copenhagen & Coffee Mind

Get Connected



App Overview

The IKAWA Pro App delivers hands-free roasting with digital precision + consistency.

Try the App

Download it free now.



APPLE



ANDROID

Connect Via Bluetooth

1. Edit profiles with up to 20 control points on the temperature line, and 10 on the airflow.
2. Download and share profiles with your team via email, text, and more.
3. Automatically logs each roast for follow up evaluation.
4. Export to Cropster to maintain your process.

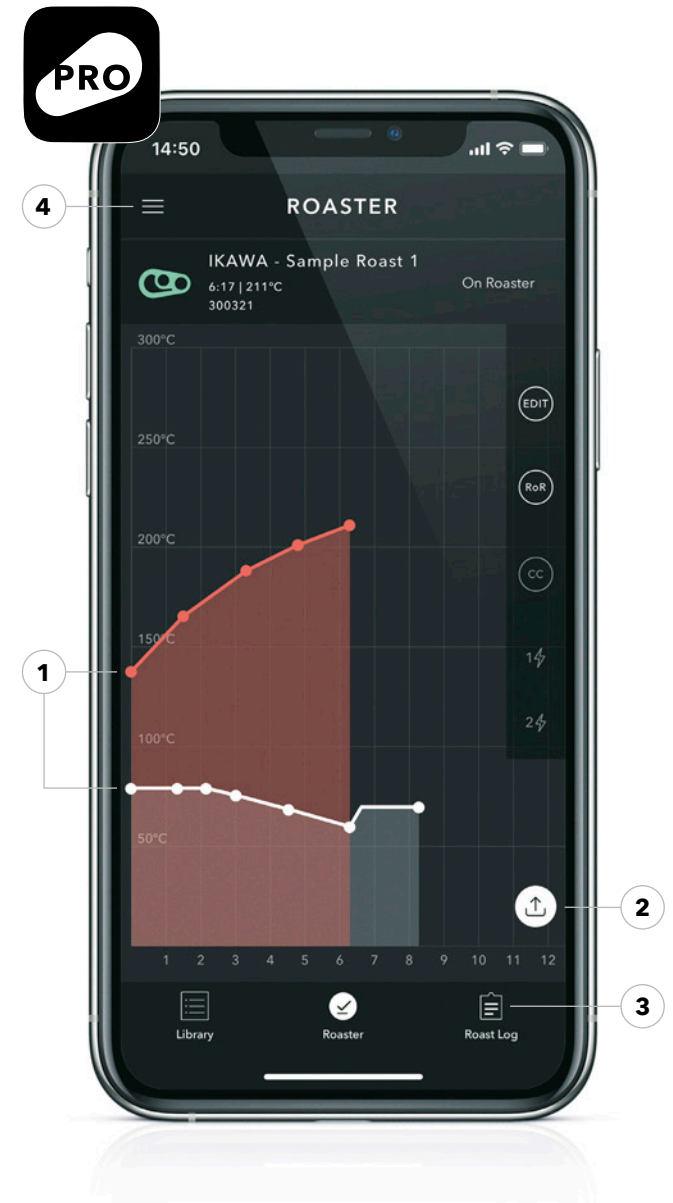

Roast Profile Library

Over 50 roast profiles from coffee professionals around the world.

IKAWA Online Roast Profile Library

Access User Favourites, World Barista and Brewers Cup roasts, and sample roasts for a variety of coffees.

Using a profile is as simple as pressing USE THIS PROFILE.

To browse the library, go to ikawacoffee.com/pro-library

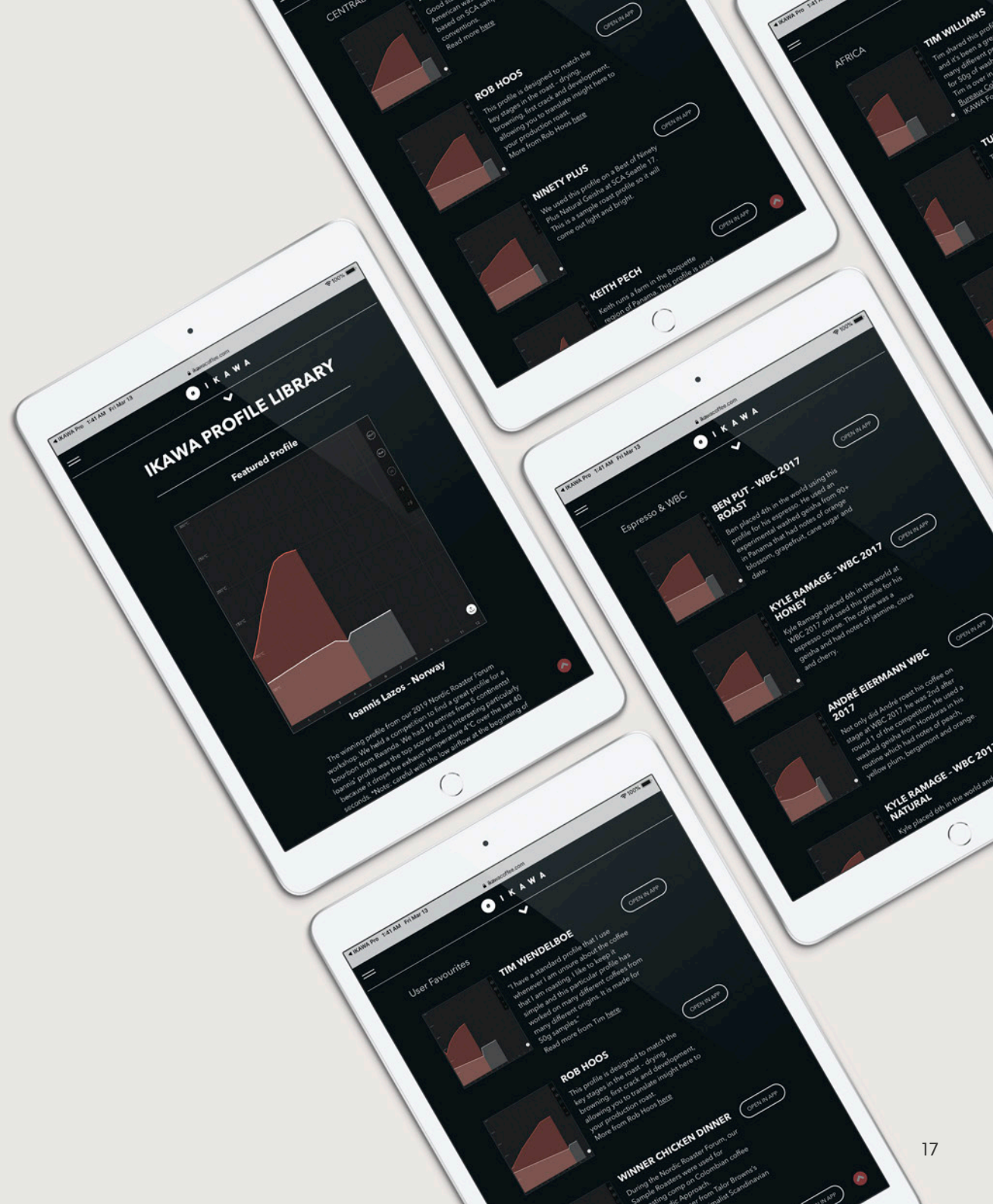

Technical Specs

IKAWA SAMPLE ROASTER FOR PROFESSIONALS

Model	Pro50	Pro100
Mains Supply	100V, 110m-130V or 220-240V	110-130V or 220-240V
Power	1.35kw, 1.4kw or 1.5kw max	1.65kw or 1.7kw max
Capacity	60g (2.1 oz) green coffee	120g (4.2 oz) green coffee
Dimensions	240 x 130 x 325mm (9.4 x 5.1 x 12.8 in)	240 x 130 x 345mm (9.4 x 5.1 x 13.6 in)
Weight	4.12kg (9.1lbs)	4.35kg (9.6lbs)
Design Features	Temperature Sensors - IKAWA Strong Pt1000-A Exhaust Sensor, Pt1000-C Inlet Sensor Temperature Control - Proportional, Integral, Differential, Predictive-Jayaram (PID-J) Integrated cyclone for chaff collection and consistent air flow PID-J controlled fan	
Safety Certifications	Conforms with IEC-60335-1 and IEC-60335-2-9, UL1026 and other international standards	
Includes	1x IKAWA Sample Roaster, 2x collection jar, 1x power lead, 1x IKAWA Travel Case, 1x felt cover, access to IKAWA profile library	

IKAWA PRO APP

App	Free to download from iTunes App Store and Google Play Store
System	iOS and Android
Connection	Bluetooth 4.0@
Roast Points	Up to 20 temperature points on each sensor line and 10 airflow points
Roast Time	0-20 minutes: sample roasts typically take 5-10 minutes
During Roast	Real Time Temperature display from 2 sensors Mark turnaround time (automatic), colour change, 1st crack, 2nd crack Automatically calculates Development Time Ratio (DTR) Edit Roast Profiles during roast View Rate of Rise graph Custom cooling parameters
After Roast	Save roast, add notes, data, photos Data Export to CSV Share by email, text, social media
Additional Features	Cropster Integration

Contact Us

To purchase or find out more about the Pro Series, contact us at:

sales@ikawacoffee.com
+44 (0)2077295664

@ikawacoffee
#improvecoffee



IKAWA's patented Sample Roasters are designed and made in our London workshop.

They are an essential business tool for thousands of coffee professionals across the world including Coffee Roasters, Producers, Traders and Trainers.

