

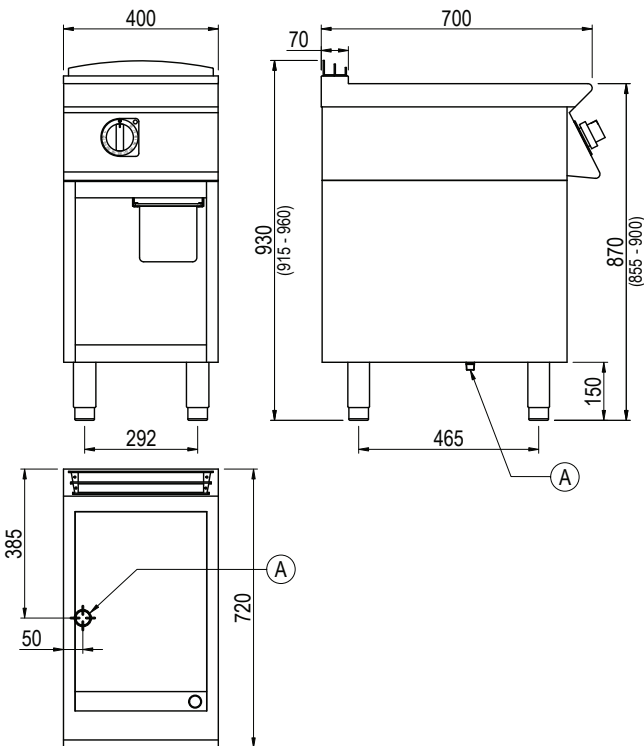

Product Information:

- Class leading, European style, professional quality and reliability since 1963
- 700 series, electric frytop with 12mm smooth mild steel plate (6.5kW)
(also available in 12mm ribbed mild steel plate)
- Heating elements with Hi-limit temperature protection
- Temperature regulation via thermostat (50°C – 300°C)
- Indicator light to monitor the correct operation of the appliance
- Robust 304 grade stainless steel construction with rounded corners for improved cleaning
- Hermetically sealed, pressed work surface with raised edges to protect from overflow
- Removable 1/3 GN grease tray
- Open base with optional door available (SPGI.2016437)
- Height adjustable stainless steel feet for a 900mm working height
- 24-month warranty

General Drawing:



Specifications:

Model - Smooth	FLE72GFT
Model - Ribbed	FRE72GFT
W x D x H (mm)	400 x 720 x 930
Weight	60kg
Cooktop (mm)	340 x 460
Packed Dimensions (mm)	450 x 825 x 1200
Packed Weight (mm)	65kg
Electrical Connection	3Ø + N + E 415VAC / 50Hz / 6.5kW

Legend:

A Electrical Connection

Due to continuous product research and development, the information contained herein is subject to change without notice.

Revision: 01 - 05/01/2022 - A

www.stoddart.com.au

www.stoddart.co.nz

