



## The Next Generation of CNC Routers

MultiCam's all-new Apex5R CNC Router takes heavy-duty and advanced manufacturing to new heights. With its sculpted exterior, powerful servos, a wealth of standard productivity features, and spindle options, the Apex5R is crafted to surpass all expectations. With motion speeds exceeding 4,500 inches per minute (IPM) and a 200% increase in acceleration over previous models, this rigid cutting system brings you unparalleled cut quality and productivity.



### Solid Heavy-Duty Construction

#### Tube Steel & Helical Rack

The Apex5R's base frame is made of tube steel that has been welded, stress-relieved, and precision milled on top and sides. Helical racks for both X&Y axis coupled with 25mm rails provide superior motion, delivering greater accuracy and smoother cuts.

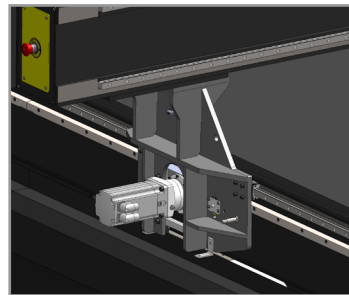

### Large Risers & Steel Gantry

#### High Strength & Improved Cut Quality

Structural 8"x12" tube steel gantry reinforced with welded bar stock, precisely milled datums, and risers having 60% more contact surface than its predecessor aids in minimizing vibrations.



### Ergonomic Workstation

#### User Friendly Design & Interface

Delivering the best operator experience with quick reach to pneumatic vacuum switches, keypad holder, and consumables drawer with adjustable shelf.

*\*Optional add-on computer screen shown with side access USB Ports.*

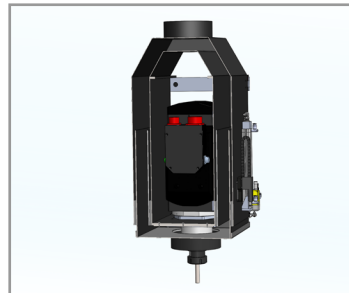

### Active Z Axis Dust Collector

#### Maximum Particulate Pickup

Full high flow dust boot that automatically adjusts position to maintain dust bristles at surface of material regardless of tool length or depth of cut.

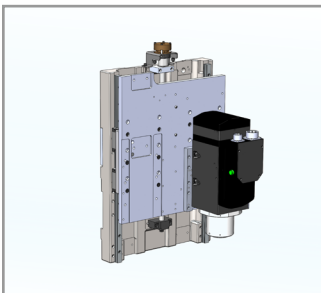

### Expanded Carriage

#### Extra Wide Aluminum Cast Plate

Over 400 times stronger than aluminum plate, creating a rigid Z platform handling up to a 20HP spindle and leaving room for standard cutting accessories.

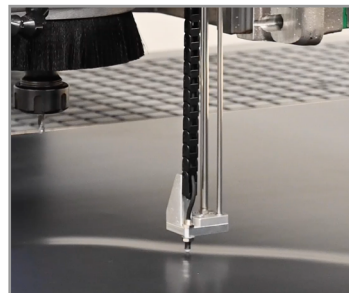

### Surface Probe & Calibration Sensor

#### Easy & Hands Free

Reduce machine setup time with this automated hands free option. Easily set tooling lengths and material work surface accurately.



### Spindle

#### 24K RPM to 32K RPM

Numerous manual and ATC spindle options to cover any cutting application. High horsepower spindles for large tooling and higher chip load on dense materials to high RPM's spindle for supreme edge final pass cutting on non-ferrous metals and plastics.

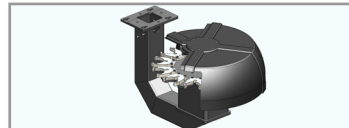

### Automatic Tool Changer

#### Covered Rotary or Linear Rack

Maximize efficiency when multiple tools are required. RATC comes standard with 12 tool positions and protection against particulate which can create improper spindle tool pickup with pneumatic cover & auto blow off.



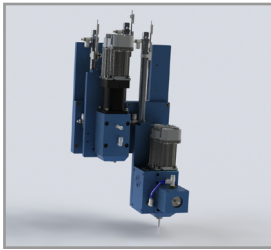

### Multi-Use Tool

**Tapper, Drag, & Oscillating Knives**  
Quick change device enables auto pick up of different knives and tapping tools. Tap function is able to tap 3/4" (19mm) Aluminum with 1/2" (13mm) tap.

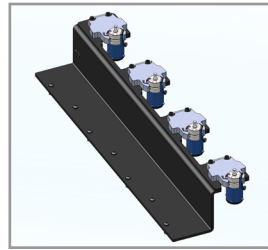

### Multi-Use Tool Changer

**Increase Productivity**  
Automatic knife or tap tool changer rack sets the machine up for a variety of operations which increases productivity and operator safety. Automatically picking up the correct tool reduces operator error saving time and material costs.

### Options:

- Laser Pointer – easily set soft home on material
- Pop-Up Pins – one man load and alignment
- Auto Mister for cutting non-ferrous metals
- Gang Drill
- Dust Collection Systems with Duct Work
- Tooling Kits



### MultiVision

#### Dynamic Digital Registration

MultiVision provides additional flexibility by visually recognizing media registration marks and automatically compensating for skew and image drift.



### EZ Control

#### Powerful, Intuitive Control

MultiCam's EZ Control provides all users, from novice to advanced, with the most powerful and easy-to-use control system available on today's market. New operators can be productive in as little as an hour.

Specifications	Inches	Metric
*Max Material Thickness	6-8"	152.4-203.2mm
Gantry Height	8", 12"	203.2mm, 304.8mm
Cutting Speed	3240 IPM	1371.6 mm/sec
Rapid Traverse	4580 IPM	1938.9 mm/sec
Repeatability	+/-0.001"	+/-0.025mm
Drive System (X,Y)	Helical	Helical
Drive System (Z)	Ball Screw	Ball Screw
Standard Work Surface	1" Phenolic	25.4mm Phenolic

* Model	Inches	Metric
204	63" x 121"	1600mm x 3073mm
205	63" x 144"	1600mm x 3658mm
304	83" x 121"	2108mm x 3073mm
305	83" x 144"	2108mm x 3658mm

\*Other sizes available

Specifications subject to change without notice.

\*Stock machine comes with standard 8" gantry clearance.

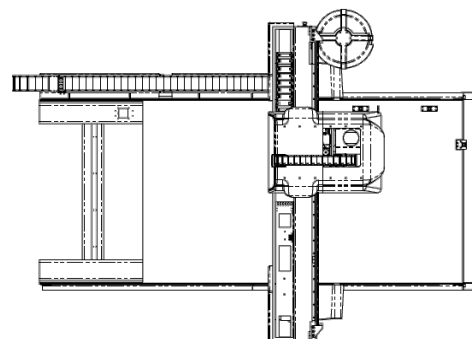
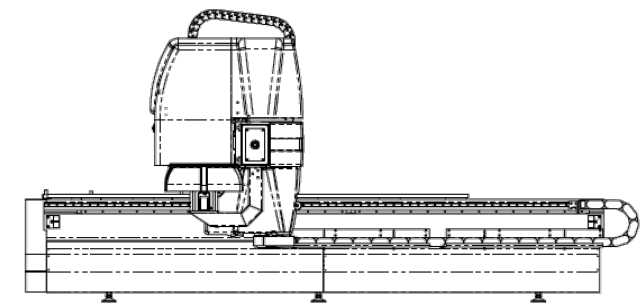
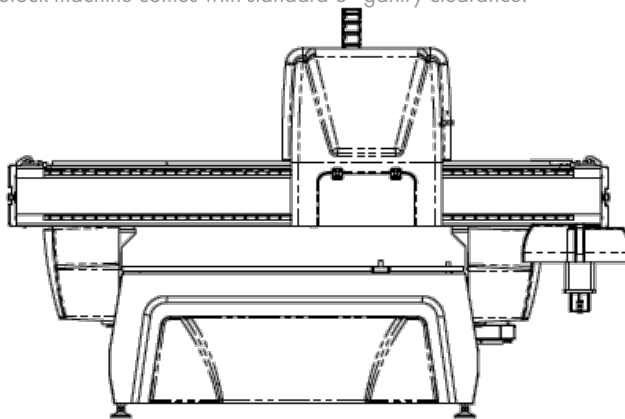

### CAS TECHNOLOGY PTE LTD

A 10 Ubi Crescent  
#05-52 Ubi Techpark (Lobby C)  
Singapore 408564

T (65) 6742 8355  
F (65) 6742 9897  
W www.castechnology.com.sg

972.929.4070  
www.multicam.com

