

FERTIKIT™ 3G

SALES DOCUMENTATION

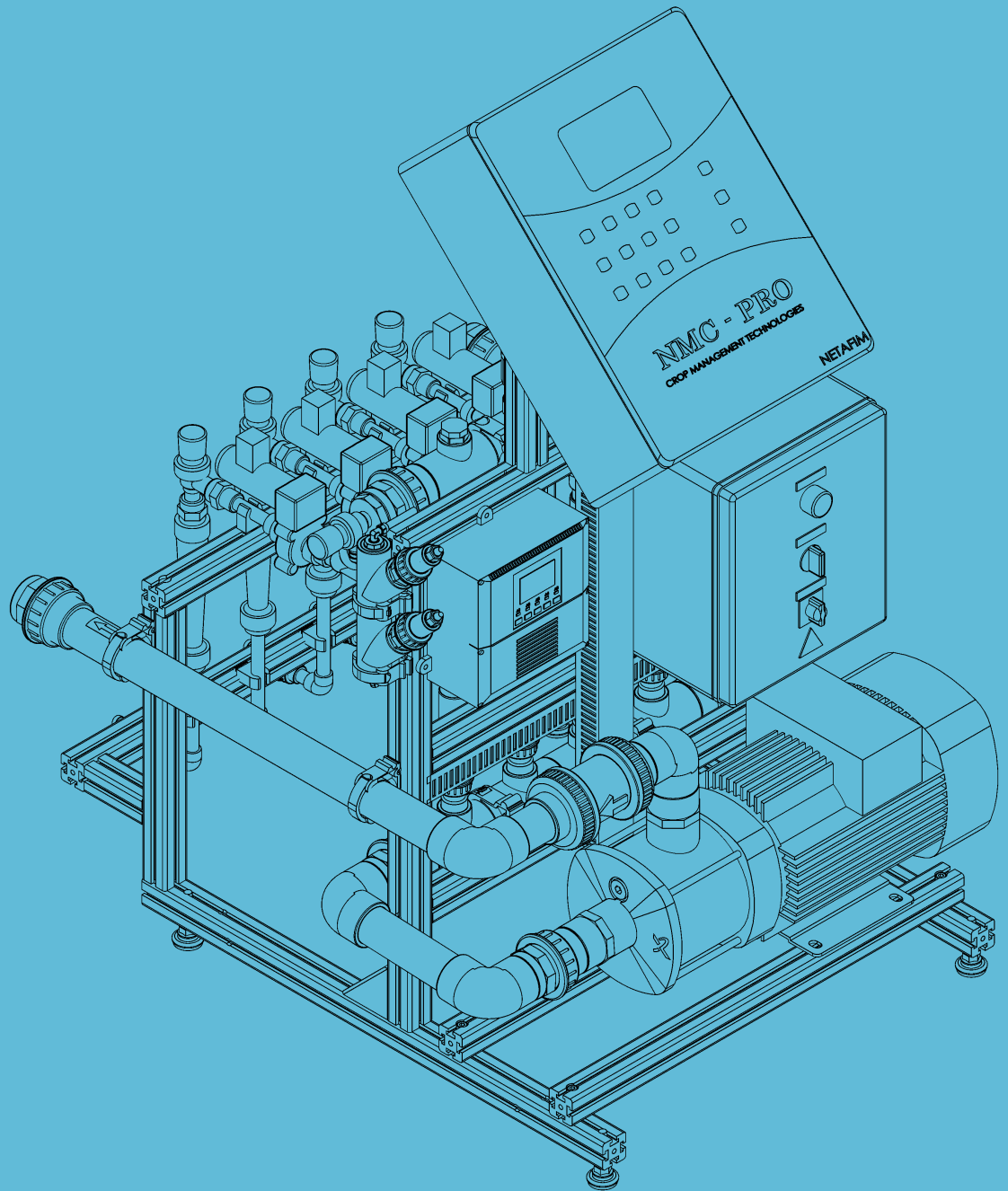

Use of symbols

The symbols used in this manual refer to the following:



WARNING

The following text contains instructions aimed at preventing bodily injury or direct damage to the crops, the product and/or the infrastructure.



CAUTION

The following text contains instructions aimed at preventing unwanted system operation, installation or conditions that, if not followed, might void the warranty.



ATTENTION

The following text contains instructions aimed at enhancing the efficiency of usage of the instructions in the manual.



NOTE

The following text contains instructions aimed at emphasizing certain aspect of the operation of the system or installation.



ACID HAZARD

The following text contains instructions aimed at preventing bodily injury or direct damage to the crops, the product and/or the infrastructure in the presence of acid.



TIP

The following text provides clarification, tips or useful information.



PROTECTIVE EQUIPMENT

The following text contains instructions aimed at preventing damage to health or bodily injury in the presence of fertilizers, acid or other chemicals.

© COPYRIGHT 2013, NETAFIM™

NO PARTS OF THIS PUBLICATION MAY BE REPRODUCED, STORED IN AN AUTOMATED DATA FILE OR MADE PUBLIC IN ANY FORM OR BY ANY MEANS, WHETHER ELECTRONIC, MECHANICAL, BY PHOTOCOPYING, RECORDING OR IN ANY OTHER MANNER WITHOUT PRIOR WRITTEN PERMISSION OF THE PUBLISHER.

ALTHOUGH NETAFIM™ TAKES THE GREATEST POSSIBLE CARE IN DESIGNING AND PRODUCING BOTH ITS PRODUCTS AND THE ASSOCIATED DOCUMENTATION, THEY MAY STILL INCLUDE FAULTS.

NETAFIM™ WILL NOT ACCEPT RESPONSIBILITY FOR DAMAGE RESULTING FROM USE OF NETAFIM'S PRODUCTS OR USE OF THIS MANUAL.

NETAFIM™ RESERVES THE RIGHT TO MAKE CHANGES AND IMPROVEMENTS TO ITS PRODUCTS AND/OR THE ASSOCIATED DOCUMENTATION WITHOUT PRIOR NOTICE.



FOREIGN LANGUAGES

In the event that you are reading this manual in a language other than the English language, you acknowledge and agree that the English language version shall prevail in case of inconsistency or contradiction in interpretation or translation.

CONTENTS

The FertiKit™ 3G

| | |
|--|---|
| Description | 4 |
| Advantages | 4 |
| Basic functions | 4 |
| Operating principle | 5 |
| Modularity | 5 |
| Compatibility | 5 |
| Service | 5 |
| Maintenance | 5 |
| Typical installation overview | 6 |
| Main parts of the FertiKit™ and its infrastructure | 6 |

Selecting a FertiKit™

| | |
|---|----|
| PL modes (PL/PS/PR/RL) | 7 |
| PB mode | 8 |
| SP mode | 9 |
| MS mode (MS/RS) | 10 |
| IL mode | 11 |
| ST mode | 12 |
| PD mode | 13 |
| Dosing channels | 14 |
| Preventing damage to the dosing booster due to cavitation | 18 |
| Electrical supply | 18 |
| Dosing boosters | 19 |
| EC/pH control | 19 |
| Controllers | 20 |

Installation requirements

| | |
|-------------------------|----|
| Infrastructure | 23 |
| Electrical installation | 24 |
| Flow rate stability | 24 |
| Source water | 24 |

Dimensions and weights

| | |
|--|----|
| Dimensions | 25 |
| Weights | 25 |
| Location of inlet, outlet and fertilizer/acid lines connectors | 26 |
| Fertilizer/acid lines connection types | 26 |
| Inlet and outlet connection types | 26 |

Safety and warranty

| | |
|------------------------------|----|
| Safety | 27 |
| Warranty | 28 |
| CE declaration of conformity | 29 |

Appendices

| | |
|---|----|
| Appendix 1 - Performance curves for selection of the dosing booster | 30 |
| Appendix 2 - FertiKit™ summary of combinations | 34 |
| Appendix 3 - List of configurator items | 35 |
| Appendix 4 - On-line configurator | 36 |
| Appendix 5 - Dosing ratio estimates | 37 |

THE FERTIKIT™ 3G

Description

The FertiKit™ 3G is a fully configurable fertilizer/acid dosing unit - a highly cost-effective solution for precise Nutrigation™.

Based on a standard platform, the FertiKit™ offers 7 different operation modes, selectable according to the site conditions, in order to maximize usage of available water flow rate and pressure on the main irrigation line, ensuring the highest efficiency with minimum investment.

The FertiKit™ can accommodate a variety of dosing channels, dosing boosters, controllers, peripherals and accessories to meet a vast range of applications and infrastructure constraints.

Capacity range

The FertiKit™ ensures a satisfactory mixture in an extremely vast range of flow capacities.

It will accommodate a 0.1 Ha (0.25 Acres) nursery or a 400 Ha (1000 Acres) sugar cane plantation.

Main line pressure range: up to 8.5 bars (123.0 PSI).

Main line flow rate range: from 1.0 to 700.0 m³/h (from 4.4 to 3000.0 GPM).

To select a specific flow capacity see the [Selecting a FertiKit™](#) chapter, page 7.

Advantages

- A modular Nutrigation™ system for soil or substrate applications with minimum investment
- Efficient usage of water, fertilizers and energy
- Unrivaled range of irrigation water capacities
- Designed for any application where quantitative or proportional Nutrigation™ is required
- Highly profitable price/performance ratio
- Venturi operating principle - no moving parts
- Fits easily into any existing irrigation system
- Precise Nutrigation™ based on high-accuracy dosing channels
- Quick action dosing valves
- Available with up to 6 fertilizer/acid dosing channels
- Nutrigation™ recipes can be changed quickly and efficiently
- Can be operated manually or fully computerized
- NMC and other controllers can be assembled on the FertiKit™ for advanced Nutrigation™ control
- A wide variety of accessories and peripherals can be integrated into the FertiKit™ to enhance its functions
- High-quality components and PVC pipe work
- Aluminum, corrosion-resistant frame with adjustable legs
- Easy to install and to maintain
- Made by Netafim™

Basic functions

The FertiKit™ supports the following Nutrigation™ functions:

- Fully controlled dosing and mixing of fertilizers/acid with source water into a homogenous nutrient solution.
- EC/pH correction of the nutrient solution.
- Water pre-treatment

THE FERTIKIT™ 3G

Operating principle

The FertiKit™ doses the various fertilizers and acid into a homogeneous solution and injects it into the irrigation water main line. The suction of the fertilizers and acid in the dosing channels is based on the Venturi principle. This requires a pressure differential - available on the main line or supplied by the main line pump or the FertiKit's dosing booster.

Modularity

The modular FertiKit™ 3G concept is based upon an array of interchangeable components that enables rapid assembly of a wide range of configurations.

Each FertiKit™ is delivered according to the precise customer's order, either fully factory assembled or assembled by the local dealer.

The dealer stocks the assortment of the FertiKit™ interchangeable components.

This concept enables the dealer to assemble any specific FertiKit™ according to the customer's order, saving the need to stock a large quantity of fully assembled FertiKit™ units of various common configurations.

The modular FertiKit™ 3G concept ensures prompt delivery schedules without delays!

Stock selection option

Enables the dosing of multiple fertilizers through a single dosing channel (in cases where simultaneous dosing is not required). Suits all modes of FertiKit™. Available in a wide variety of configurations, from a single dosing channel with 2 fertilizers to as many dosing channels and fertilizers as required. There are fertilizer combinations that at high concentration might induce crystallization in the FertiKit's lower manifold and cause clogging of the pipes (see [CAUTION](#) on page 15).

Compatibility

The FertiKit™ 3G can be incorporated in an existing or a planned project; in either case it offers a highly cost-effective solution for Nutrigation™ by taking maximum advantage of the infrastructure conditions. Any available pressure surplus can be used for the FertiKit's operation. In order to configure the most cost-effective FertiKit™, making the maximum use of available pressure, see [Selecting a Fertikit™](#), page 7.



ATTENTION

Calculations are either in metric or in US units - consistency in the type of units used is essential.



ATTENTION

Each mode can accommodate a specific range of Venturis - see [Venturis table](#), page 17.

Service

Servicing the FertiKit™ 3G is a prompt and simple process. The dealer keeps a small quantity of interchangeable components on hand, for replacement on site within a few minutes.

Maintenance

To prevent failures and extend the life cycle of the FertiKit™, regular maintenance must be carried out by the user, such as periodic rinsing of filters and calibration of the EC/pH sensors. For full maintenance instructions, see [Maintenance](#) in the [User Manual](#) at <http://www.netafim.com/product/fertikit-3g>.

THE FERTIKIT™ 3G

Typical installation overview

The drawing below represents the typical infrastructure suitable for the **PL** mode. Each one of the FertiKit™ 3G 7 modes fits a different infrastructure configuration. (see the schematic diagrams in [Modes](#), pages 7-13).

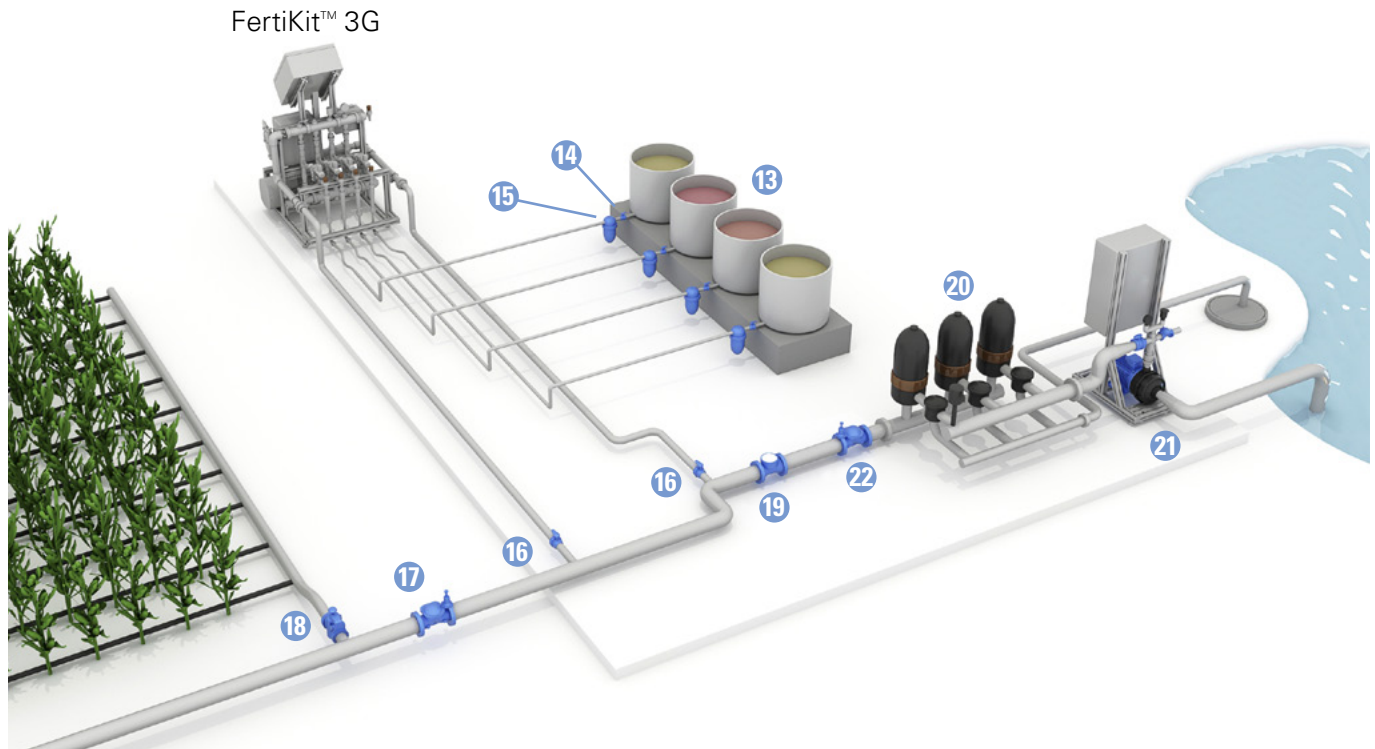

Main parts of the FertiKit™ and its infrastructure

The list below presents the Main parts of the FertiKit™ and the parts of the infrastructure required for the operation of the FertiKit™ various modes (see [pages 7-13](#)).

- | | | |
|---------------------------------|--|--|
| 1 Dosing channel + Venturi | 12 Pressure switch | 22 Main line pressure reducing valve (PRV) |
| 2 Upper manifold pressure gauge | 13 Fertilizer/acid stock tank | 23 Sampling outlet |
| 3 Lower manifold pressure gauge | 14 Manual valve (fertilizer) | 24 Saddle fitting |
| 4 Sampling outlet | 15 Fertilizer/acid filter | 25 Command tube |
| 5 Controller | 16 Manual valve (isolation) | 26 Pressure sustaining valve (PSV) |
| 6 EC sensor | 17 Main line pressure sustaining valve (PSV) | 27 Pressure reducing valve (PRV) |
| 7 pH sensor | 18 Irrigation valve | 28 Water meter |
| 8 EC/pH transducer | 19 Water meter | 29 Air release valve |
| 9 Dosing booster | 20 Main line filter | |
| 10 Dosing booster switchbox | 21 Main line pump | |
| 11 Check valve | | |

Color code: ● Supplied (part of the FertiKit™), ● Not supplied (part of infrastructure), ● Optional.

SELECTING A FERTIKIT™

PL modes (PL/PS/PR/RL)

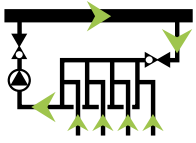

Operating principle: The pressure differential required to generate fertilizer suction via the Venturis is produced by a booster pump integrated in the FertiKit™.

These modes of operation, where the lower manifold is under low pressure (around 0 bars/PSI), permits the use of high-efficiency Venturis with high suction capacity and low motive flow consumption.

Flow rate: 20 - 700 m³/h (85 - 3000 GPM)

Suitable for main line pressure:

PL: 2.5 - 6.5 bars (36 - 94 PSI).

PR with PRV **27**: 6.5 - 8.5 bars (94 - 123 PSI)

PS with PSV **26**: Based on cavitation risk (see [page 18](#)).

RL with PRV **27** and PSV **26**: 2.5 - 8.5 bars (36 - 123 PSI)

Dosing channels:

Accommodates a wide variety of dosing channels for fertilizer and concentrated/diluted acid:

- Up to 6 x 50 - 1000 l/h (13 - 265 GPH)
- Optional - Concentrated acid channel, 50 l/h (13 GPH).

Total fertilizer/acid suction capacity - up to 6000 l/h (1585 GPH).

Controller: NMC-Pro, NMC-XL, NMC-Junior, (Other controllers or manual system without controller - optional).

EC/pH: Single, monitoring and control.

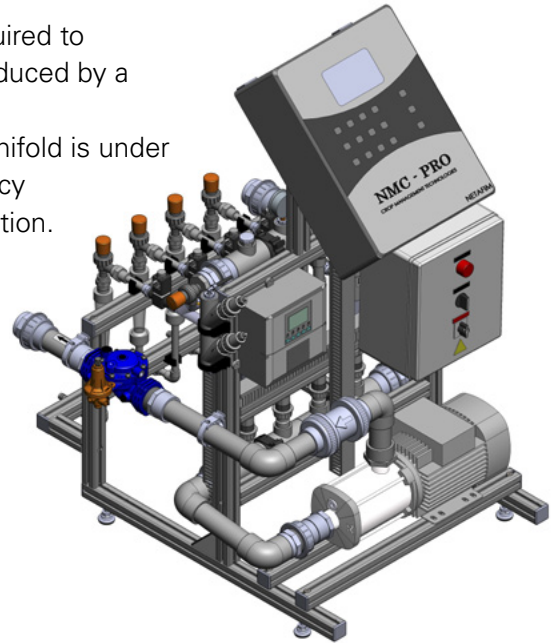

Schematic diagram

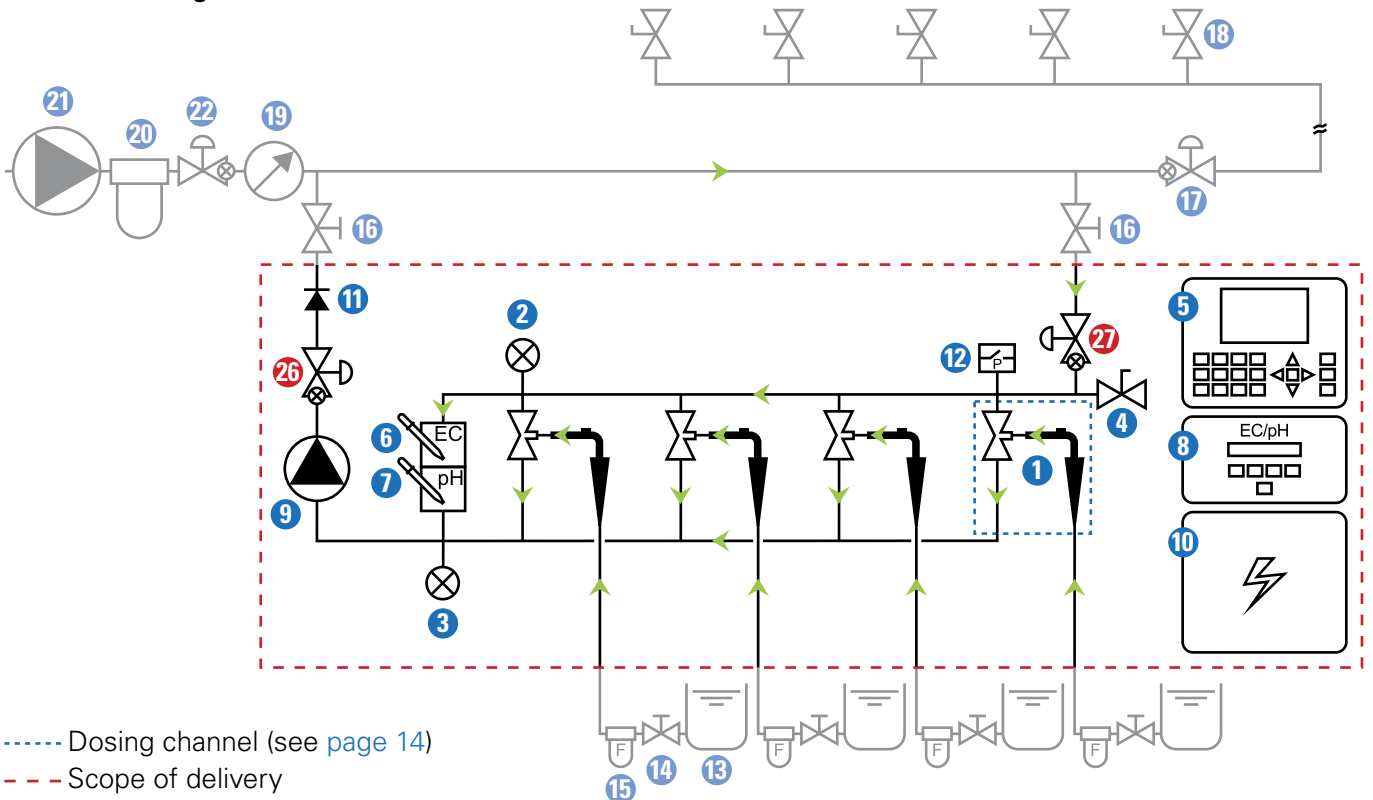

----- Dosing channel (see [page 14](#))

- - - - - Scope of delivery

➔ Direction of flow

See [legend](#) on page 6.

SELECTING A FERTIKIT™

PB mode

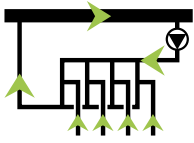

Operating principle: The pressure differential required to generate fertilizer suction via the Venturis is produced by a booster pump integrated in the FertiKit™.

This mode of operation, where the smaller system pump is installed upstream from the Venturis, permits the use of a small booster pump, reducing the investment required and saving energy. This mode is suitable for relatively low flow rates and pressures.

Flow rate: 5 - 70 m³/h (22 - 300 GPM)

Suitable for main line pressure: 1.5 - 2.5 bars (22 - 36 PSI)

Additional conditions:

The pressure supplied by the dosing booster is added to the main line pressure. Their sum (in the upper manifold) should not exceed 6.5 bars (94 PSI)

Dosing channels:

Accommodates a wide variety of dosing channels for fertilizer and concentrated/diluted acid:

- Up to 4 x 50 - 370 l/h (13 - 100 GPH)
- Optional - Concentrated acid channel, 50 l/h (13 GPH).

Total fertilizer/acid suction capacity - up to 1480 l/h (390 GPH).

Controller: NMC-Pro, NMC-XL, NMC-Junior, (Other controllers or manual system without controller - optional).

EC/pH: Single, monitoring and control.

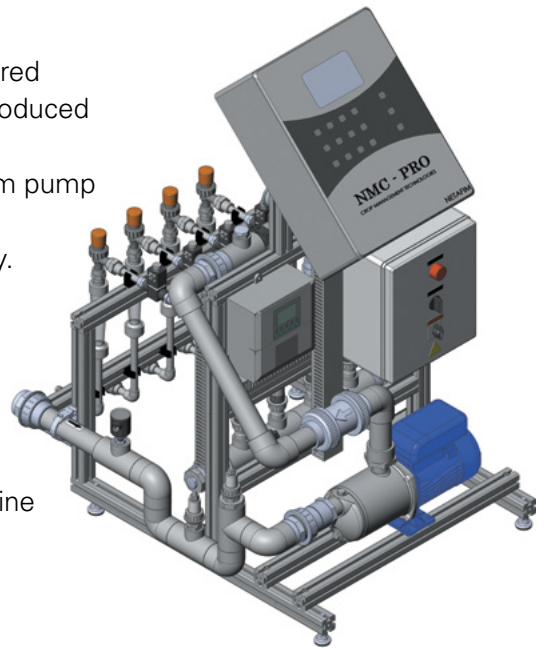

Schematic diagram

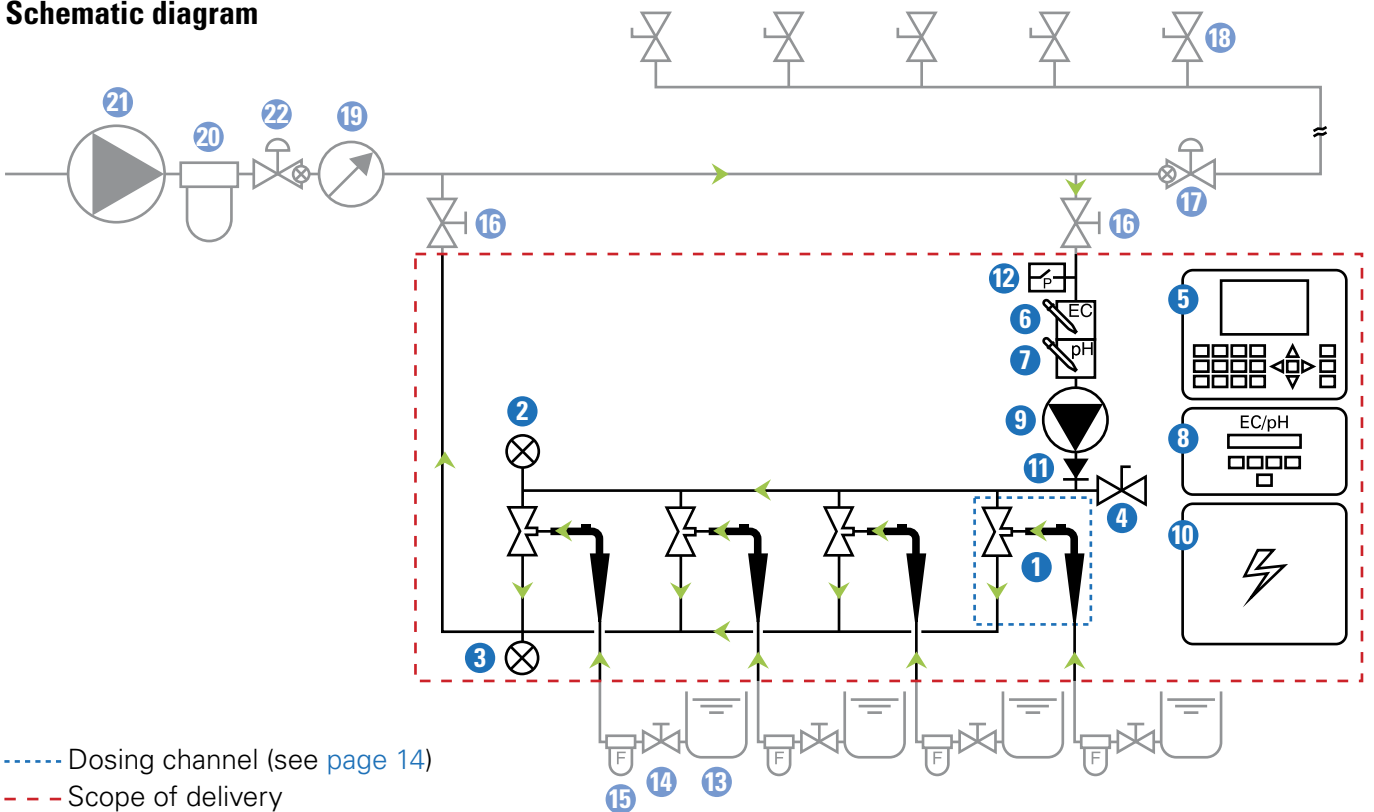

..... Dosing channel (see page 14)

- - - - - Scope of delivery

→ Direction of flow

See legend on page 6.

SELECTING A FERTIKIT™

SP mode

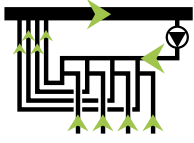

Operating principle: The pressure differential required to generate fertilizer suction via the Venturis is produced by a booster pump integrated in the FertiKit™.

This mode of operation, where the system pump is installed upstream from the Venturis, permits the use of a smaller booster pump, reducing the investment required and saving energy. This mode is suitable for relatively low flow rates and pressures. For applications that use very high concentration fertilizers and acid. The solution has to be mixed in the main line. SP mode is not equipped with a lower manifold. (Can be supplied to the USA market with all parts inch-based to facilitate replacement using locally available spare parts).

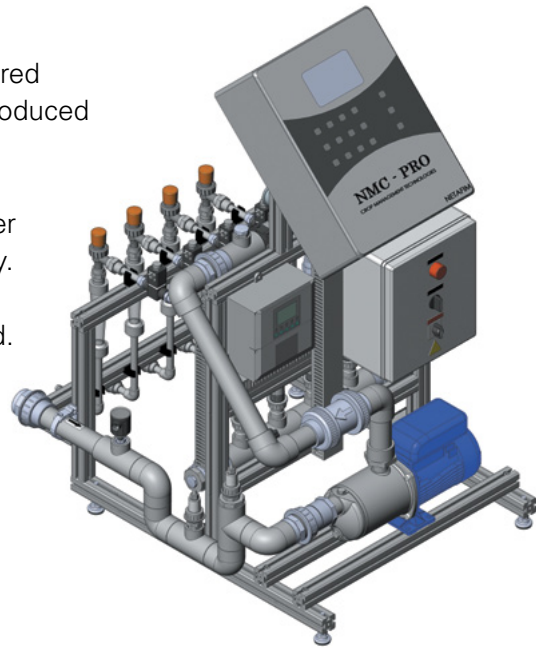

Flow rate: 5 - 250 m³/h (22 - 1100 GPM)

Suitable for main line pressure: 1.5 - 3.5 bars (22 - 51 PSI)

Dosing channels:

Accommodates a wide variety of dosing channels for fertilizer and concentrated/diluted acid:

- Up to 4 x 50 - 370 l/h (13 - 100 GPH)
- Optional - Concentrated acid channel, 50 l/h (13 GPH).

Total fertilizer/acid suction capacity - up to 1480 l/h (400 GPH).

Controller: NMC-Pro, NMC-XL, NMC-Junior, (Other controllers or manual system without controller - optional).

EC/pH: Single, monitoring and control.

Schematic diagram

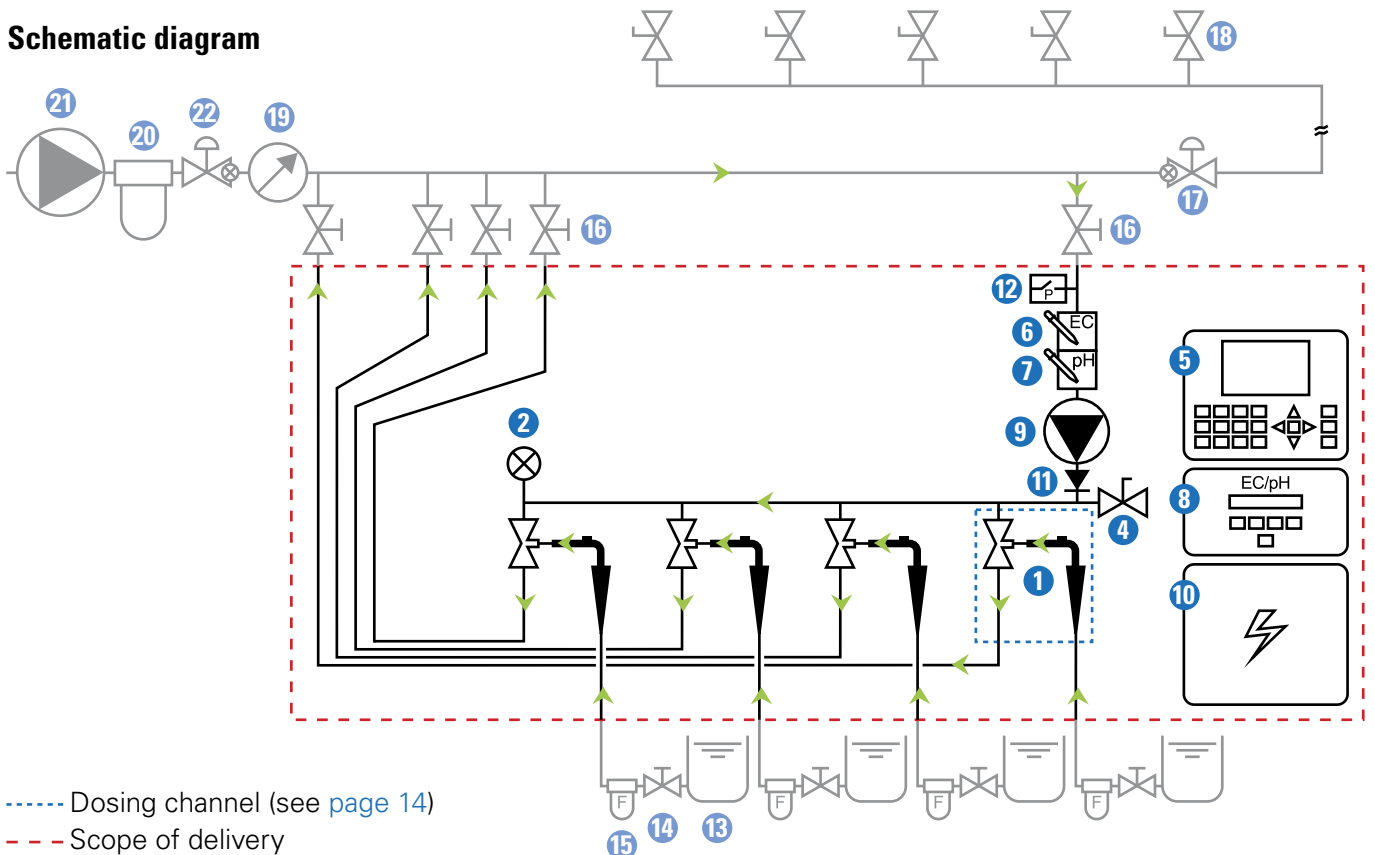

----- Dosing channel (see page 14)

- - - - - Scope of delivery

→ Direction of flow

See legend on page 6.

SELECTING A FERTIKIT™

MS mode (MS/RS)

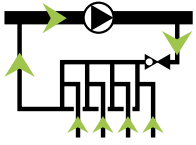

Operating principle: For systems operating under negative suction - from a reservoir or a tank [max. height: 6 meters (20 feet)] Utilizes the main line pump pressure. Saves the need for a dosing booster.

Flow rate: 20 - 700 m³/h (85 - 3000 GPM)

Suitable for main line pressure:

Upstream from the pump: -0.3 – +0.6 bar (-4 – +9 PSI)

At the outlet of the pump: 2.5 – 6.5 bars (36 – 94 PSI)

RS with PRV (21):

6.5 – 8.5 bars (94 – 123 PSI) at the FertiKit™ inlet.

Additional conditions:

Requires the connection of the FertiKit's outlet to the main line upstream from the pump.

The main line pump should be able to deliver the flow rate required for the operation of the FertiKit™ + the field consumption.

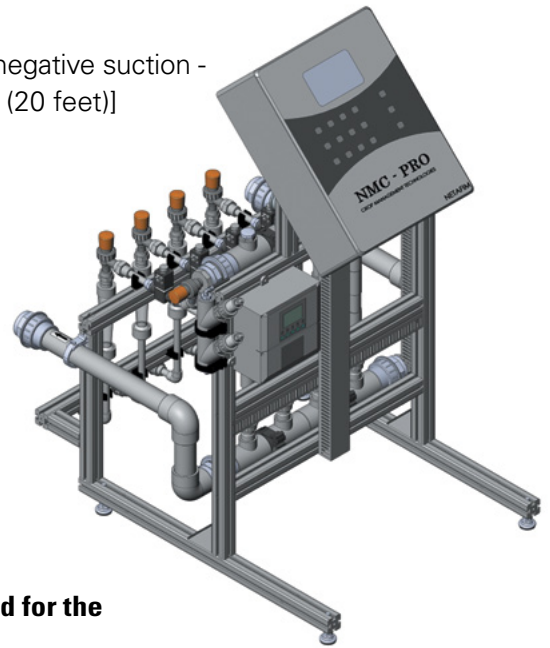

Dosing channels:

Accommodates a wide variety of dosing channels for fertilizer and concentrated/diluted acid:

- Up to 6 x 50 - 1000 l/h (13 - 265 GPH)
- Optional - Concentrated acid channel, 50 l/h (13 GPH).

Total fertilizer/acid suction capacity - up to 6000 l/h (1585 GPH).

Controller: NMC-Pro, NMC-XL, NMC-Junior, (Other controllers or manual system without controller - optional).

EC/pH: Single, monitoring and control.

Schematic diagram

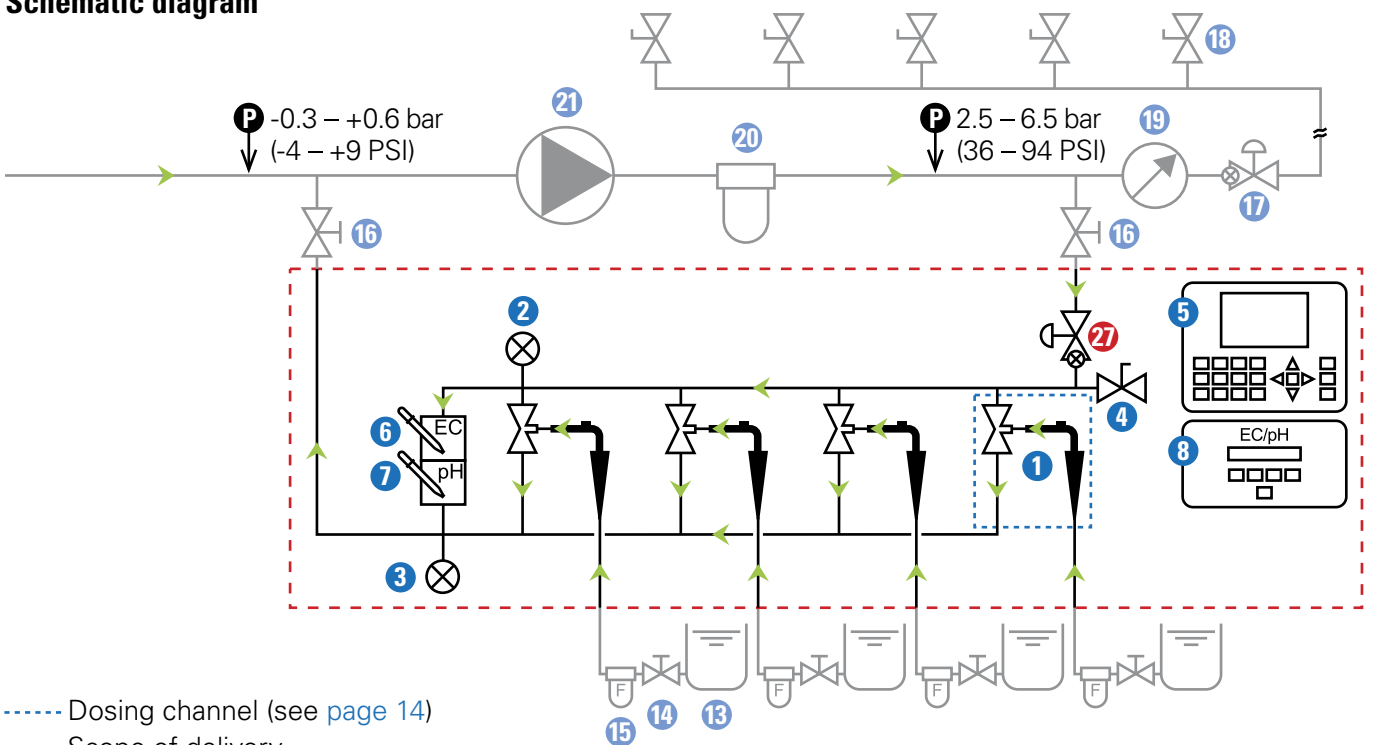

----- Dosing channel (see page 14)

- - - - - Scope of delivery

→ Direction of flow

See legend on page 6.

SELECTING A FERTIKIT™

IL mode

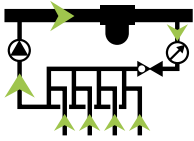

Operating principle: The pressure differential required to generate fertilizer suction via the Venturis is produced by a booster pump integrated in the FertiKit™.

In this mode of operation, the lower manifold is at low pressure (around 0 bar/psi) this allows the use of high-efficiency Venturis with high suction capacity and low motive flow consumption. Since all the main line water flows through the system, slight pressure losses at the FertiKit™ outlet should be considered (see the table below).

Flow rate: 3 - 18 m³/h (13 - 85 GPM)

Suitable for main line pressure: 2.5 - 5.5 bars (36 - 79 PSI)

Dosing channels:

Accommodates a wide variety of dosing channels for fertilizer and concentrated/diluted acid:

- Up to 6 x 50 - 600 l/h (13 - 156 GPH)
- Optional - Concentrated acid channel, 50 l/h (13 GPH).

Total fertilizer/acid suction capacity - up to 3600 l/h (950 GPH).

Controller: NMC-Pro, NMC-XL, NMC-Junior,

(Other controllers or manual system without controller - optional).

EC/pH: Single, monitoring and control.

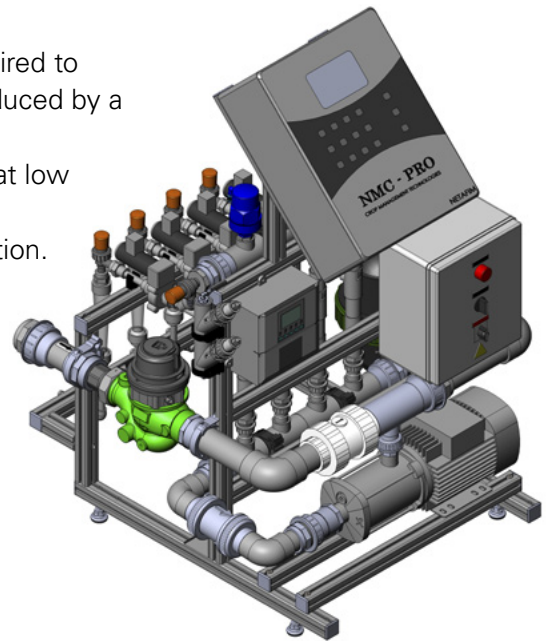

pressure losses

| Flow rate m ³ /h (GPM) | Pressure losse bar (PSI) |
|--------------------------------------|-----------------------------|
| 5 (22) | 0.1 (1.45) |
| 10 (44) | 0.3 (4.35) |
| 15 (66) | 0.6 (9.55) |

Schematic diagram

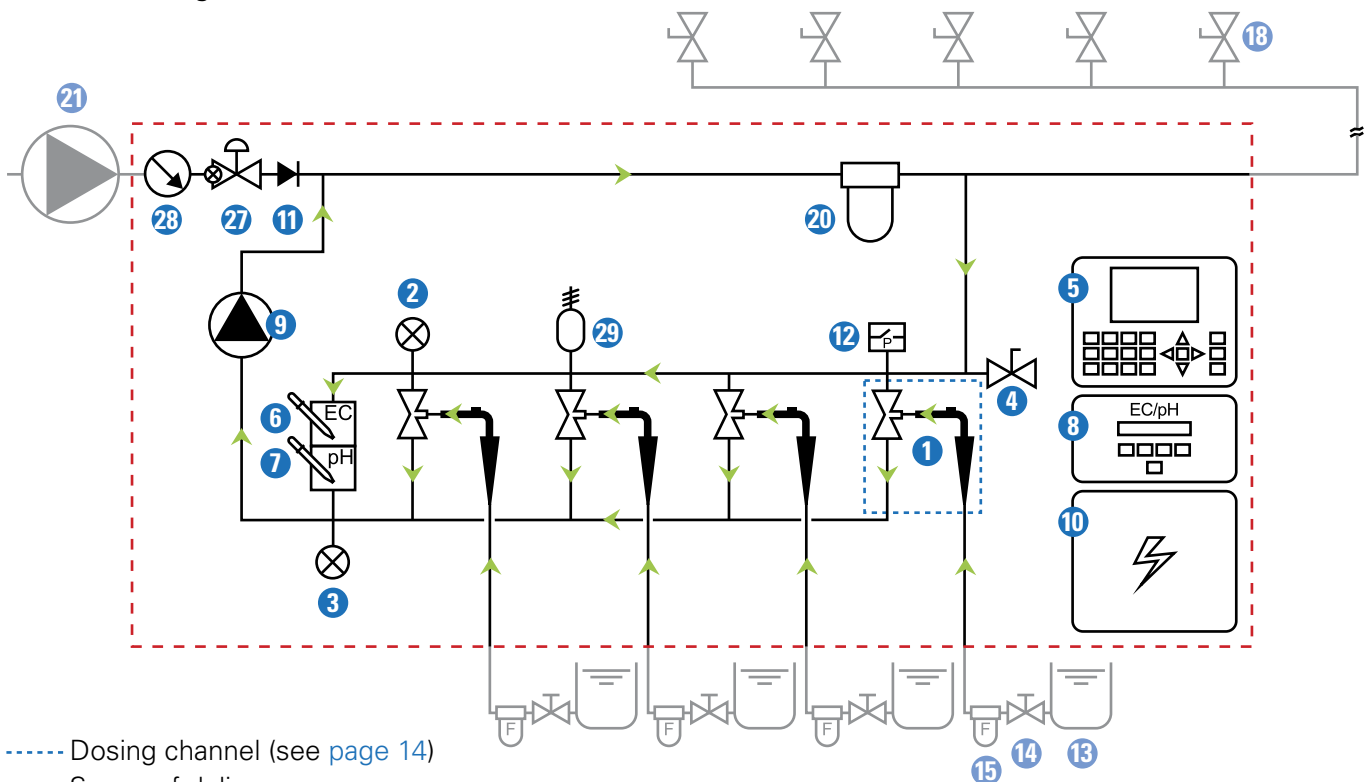

----- Dosing channel (see page 14)

- - - - - Scope of delivery

→ Direction of flow

See legend on page 6.

SELECTING A FERTIKIT™

ST mode

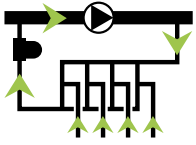

Operating principle: For systems operating at low pressure - from an on-ground reservoir or a tank [max. height: 6 meters (20 feet)]

The dosing booster pump also serves as main line pump.

Supplied with a manual or a semi-automatic filter.

Flow rate: 1 - 16 m³/h (4.4 - 70 GPM)

Suitable for main line pressure:

Upstream from the pump: -0.3 – +0.6 bar (-4 – +9 PSI)

At the outlet of the pump: 2.0 – 5.5 bars (29 – 80 PSI)

Additional conditions:

When selecting a dosing booster, consider the required field flow + the TC (TC - see page 17, [dosing booster curves](#) - see page 32-33).

Dosing channels:

Accommodates a wide variety of dosing channels for fertilizer and concentrated/diluted acid:

- Up to 6 x 50 - 600 l/h (13 - 156 GPH)
 - Optional - Concentrated acid channel, 50 l/h (13 GPH).
- Total fertilizer/acid suction capacity - up to 3600 l/h (950 GPH).

Controller: NMC-Pro, NMC-XL, NMC-Junior, (Other controllers or manual system without controller - optional).

EC/pH: Single, monitoring and control.

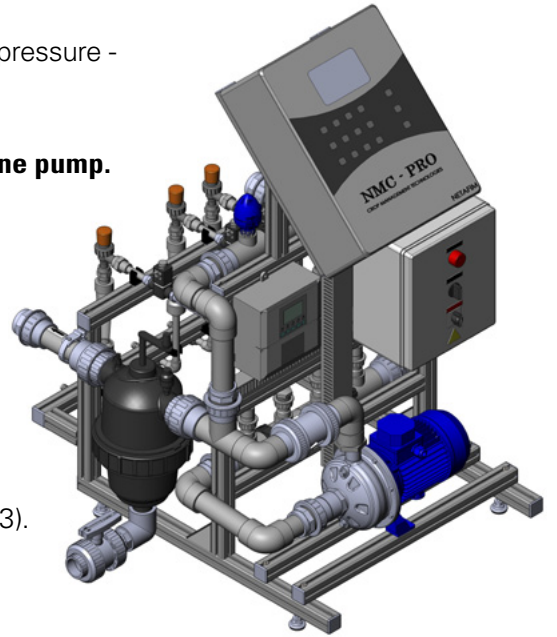

Schematic diagram

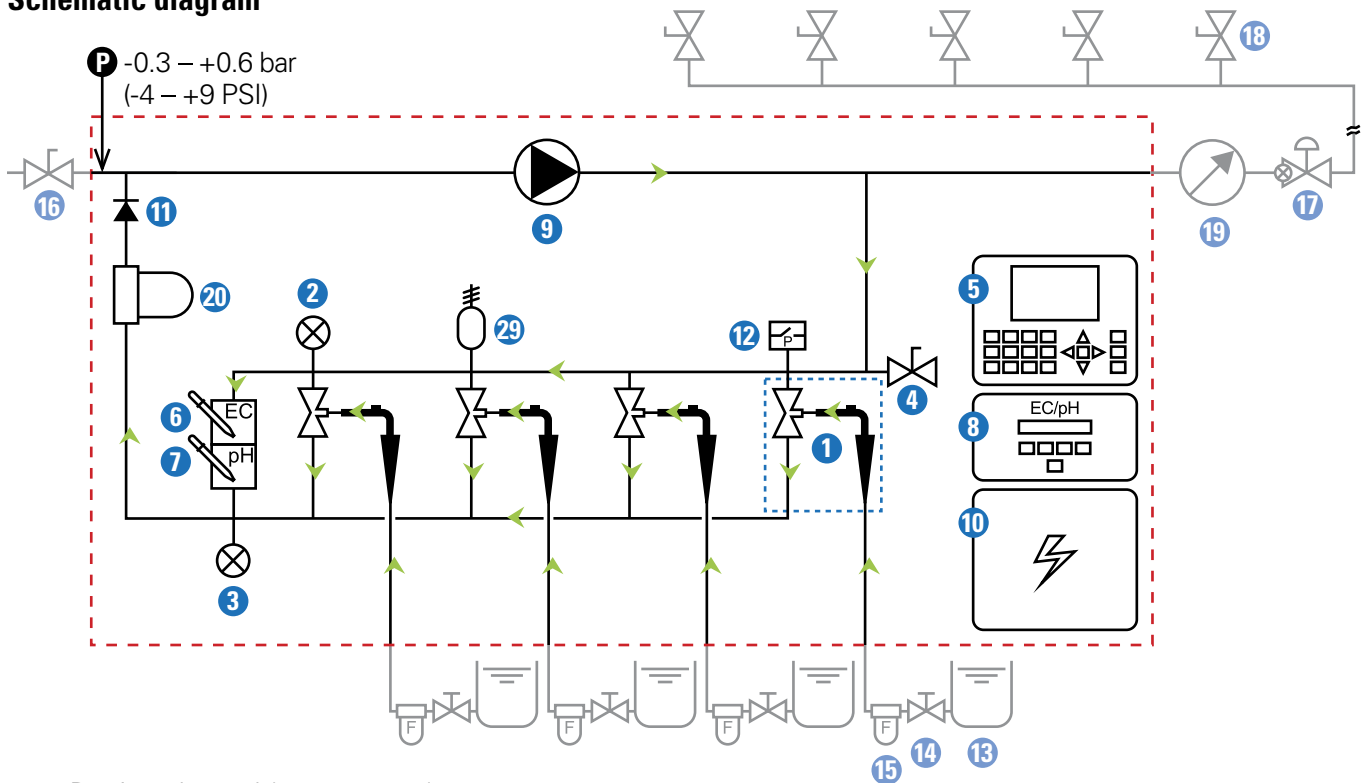

----- Dosing channel (see [page 14](#))

- - - - - Scope of delivery

→ Direction of flow

See [legend](#) on page 6.

SELECTING A FERTIKIT™

PD mode

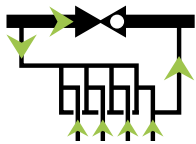

Operating principle: Utilizes the main line pressure or gravity feed.
Saves the need for a dosing booster.
Also suitable for applications where there is no electricity on the site (contact Netafim™).

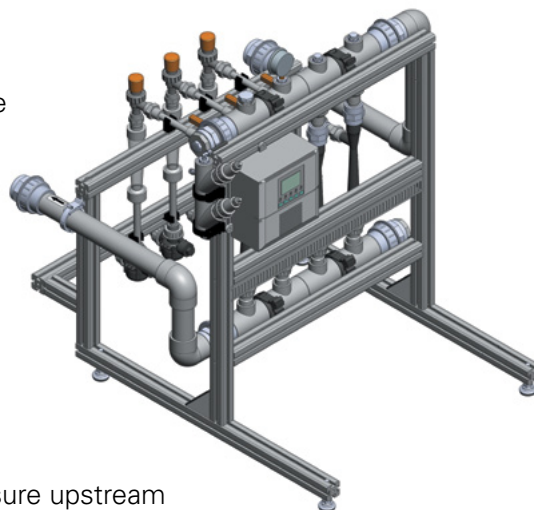

Flow rate: 10 - 200 m³/h (44 - 880 GPM)

Suitable for main line pressure: 4.5 - 8.0 Bars (65 - 116 PSI)

Additional conditions:

For the dosing channels to provide proper suction, the pressure downstream from the PRV should be at least 50% of the the pressure upstream from the PRV (The efficiency of the Venturis decreases if this condition is not met). In addition the system must supply sufficient pressure for the field demand.

Dosing channels:

Accommodates a wide variety of dosing channels for fertilizer and concentrated/diluted acid:

- Up to 4* x 50 - 370 l/h (13 - 100 GPH)
- Optional - Concentrated acid channel, 50 l/h (13 GPH).

Total fertilizer/acid suction capacity - up to 1480 l/h (390 GPH).

*If EC/pH is installed it occupies the location of one dosing channel (power required).

Controller: NMC-Pro, NMC-XL, NMC-Junior, NMC DC

(Other controllers or manual system without controller - optional).

EC/pH: None (Single monitoring only - optional)

Schematic diagram

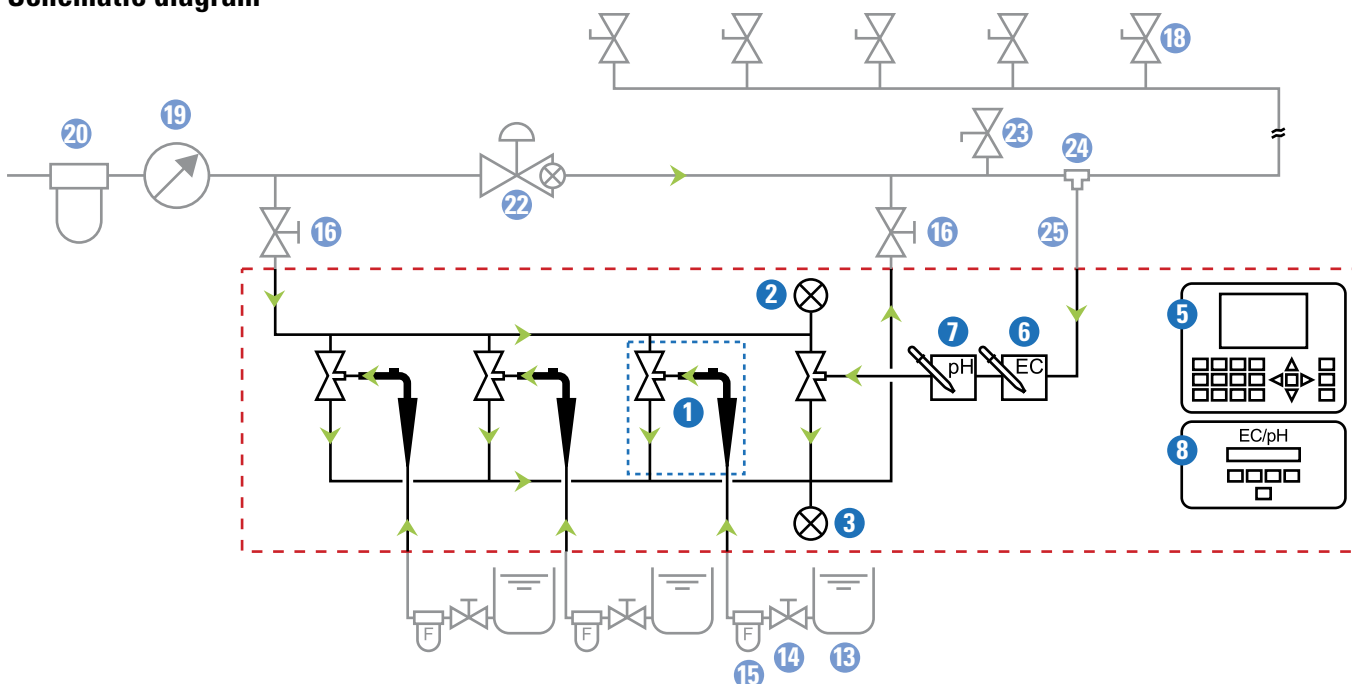

----- Dosing channel (see page 14)

- - - - - Scope of delivery













→ Direction of flow

See legend on page 6.

SELECTING A FERTIKIT™

Dosing channels

To accommodate a variety of installations, flow rates and Nutrigation™ needs, the FertiKit™ 3G offers a wide range of dosing channels for fertilizer and acid. Some of them are listed below. For a full overview go to the online configurator at <https://cmtconfig.netafim.com>.

| | | | |
|--|---|--|--|
| <p>Electrical - up to 600 l/h (158 GPH), without manual override</p>  | <p>Electrical - up to 600 l/h (158 GPH), with manual override</p>  | <p>Electrical - up to 600 l/h (158 GPH), with fertilizer meter, without manual override</p>  | <p>Electrical - up to 600 l/h (158 GPH), with fertilizer meter, with manual override</p>  |
| <p>Electrical - up to 1000 l/h (264 GPH)</p>  | <p>Electrical - up to 1000 l/h (264 GPH), with fertilizer meter</p>  | <p>Hydraulic - up to 600 l/h (158 GPH), with fertilizer meter</p>  | <p>Hydraulic - up to 1000 l/h (264 GPH)</p>  |
| <p>Manual - up to 600 l/h (158 GPH)</p>  | <p>Manual - up to 600 l/h (158 GPH), with fertilizer meter</p>  | <p>Manual - up to 1000 l/h (264 GPH)</p>  | <p>Manual - up to 1000 l/h (264 GPH), with fertilizer meter</p>  |

SELECTING A FERTIKIT™

Dosing channels for fertilizer or diluted acid

Capacity - l/h (GPH) • 50 (13) • 150 (40) • 400 (106) • 600 (158) • 1000 (265)

Each of the above dosing channels is available in any of the following options:

- AC 50 or 60 Hz - according to the electricity frequency.
- Manual - for applications without a controller.
- Hydraulic - for DC latch with RTU applications.
- Bio - for applications with high viscosity fertilizers (e.g. bio, organic), enabling controlled flushing after each irrigation shift.



CAUTION

There are fertilizer combinations that at high concentration might induce crystallization in the FertiKit's lower manifold and cause clogging of the pipes.

Fertilizer combinations prone to induce crystallization:

- Calcium Nitrate + Ammonium Sulfate => Calcium Sulfate
- Calcium Nitrate + Potassium Sulfate => Calcium Sulfate
- MKP + Calcium Nitrate => Calcium Phosphate
- MAP + Calcium Nitrate => Calcium Phosphate
- Phosphoric acid + Calcium Nitrate => Calcium Phosphate

When injecting these fertilizer combinations:

- Make sure to dilute each fertilizers to the allowed concentration in the fertilizer tank prior to injection through the FertiKit™.
- Immediately after each injection of any of the fertilizer combination above, flush the FertiKit™ with clean water for at least 2 minutes.

In case of doubt regarding the use of any combination of fertilizers, contact your Netafim™ local representative.

Dosing channel for concentrated acid

Capacity - l/h (GPH) • 50 (13) • 150 (40) • 370 (98), AC 50 or 60 Hz - according to the electricity frequency.



ATTENTION

Table 2 - When dosing acid, use a dosing channel fitted with the appropriate components according to the type and concentration of the acid used*:

| Type of dosing channel | Diaphragm and O-rings | For pH correction | | | For maintenance of drippers | | |
|------------------------|-----------------------|----------------------------|--|--|-----------------------------|--|----------------------------|
| | | Nitric (HNO ₃) | Phosphoric (H ₃ PO ₄) | Sulfuric (H ₂ SO ₄) | Hydrochloric (HCl) | Hydrogen peroxide (H ₂ O ₂) | Chlorine (as hypochlorite) |
| For diluted acid | EPDM | <3% | <85% | <30% | <10% | <30% | <1% |
| For concentrated acid | Viton | <40% | <85% | <90% | <33% | <50% | <10% |

% is by weight at 21°C (70°F)

* The table indicates the resistance of the dosing channel components to acid, and is not a recommendation to use the acids mentioned.



WARNING

Exceeding the recommended acid concentrations will damage the dosing channels.

SELECTING A FERTIKIT™

Dual dosing channel

If more than 4 dosing channels are required (up to 6), the dual dosing channel option can be used.

- Up to 2 dual dosing channels can be installed on the FertiKit™ 3G, at the 1 and 4 manifold positions.
- The dual dosing channel option is applicable with 50 l/h (13 GPH), 600 l/h (158 GPH) and 1000 l/h (265 GPH) Venturis only.

Dual dosing channel schematic diagram

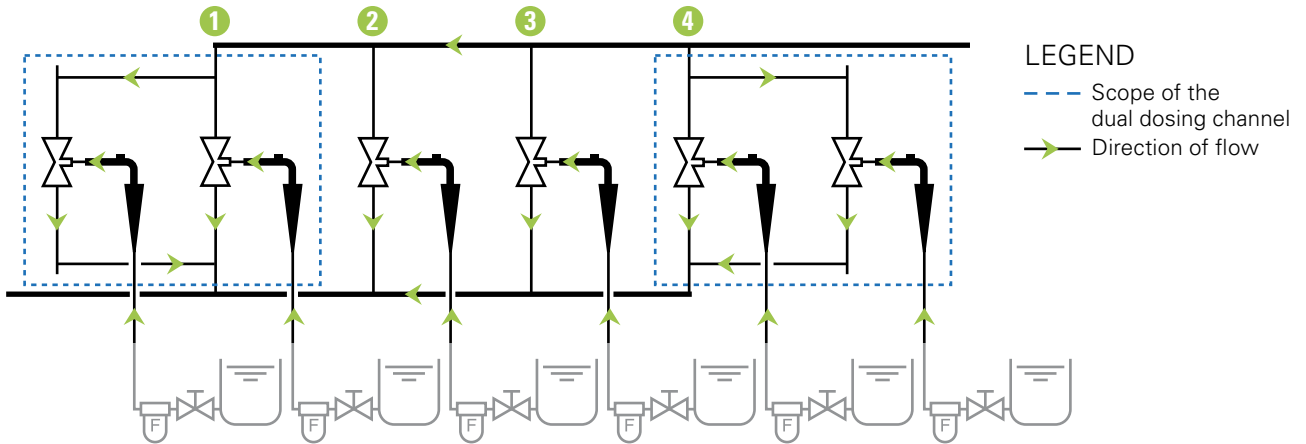

CAUTION

Only compatible products can be injected through the dual dosing channel. There are fertilizer combinations that should **never** be used in the dual dosing channel as they will induce crystallization and cause clogging of the pipes.

Fertilizer combinations prone to induce crystallization:

- Calcium Nitrate + Ammonium Sulfate => Calcium Sulfate
- Calcium Nitrate + Potassium Sulfate => Calcium Sulfate
- MKP + Calcium Nitrate => Calcium Phosphate
- MAP + Calcium Nitrate => Calcium Phosphate
- Phosphoric acid + Calcium Nitrate => Calcium Phosphate

In case of doubt regarding the use of any combination of fertilizers in the dual dosing channel, contact your Netafim™ local representative.

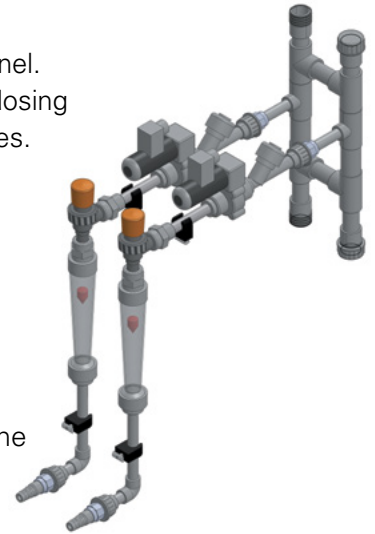

Compute the fertilizer flow rate

To select the appropriate fertilizer dosing channels and Venturis, perform the following calculation:

| | Metric units | US units |
|--|--|---|
| Enter the flow rate of the largest irrigation shift | <input type="text"/> m ³ /h | <input type="text"/> GPM |
| | X | X |
| Enter the dosing ratio of a single fertilizer (for guidelines see appendix 1 , pages 30-33) | <input type="text"/> l/m ³ | <input type="text"/> US gal/1000 US gal |
| | = | X 0.06 = |
| Result: a single fertilizer flow rate | <input type="text"/> l/h | <input type="text"/> GPH |

SELECTING A FERTIKIT™

Matching the Venturis and the dosing channels

A complete line of Venturis is available to accommodate various flow rates of fertilizer or acid.

| Venturi | Applicable for mode | Nominal suction flow - l/h (GPH) | Typical consumption* - m ³ /h (GPM) (at pressure up to 5 bars) |
|-------------|---------------------|----------------------------------|---|
| PVDF - M050 | Any mode | 50 (13) | 1.0 (4.4) |
| PP - N150 | Any mode | 150 (40) | 1.2 (5.3) |
| PP - M370 | SP/PB/PD | 370 (98) | 4.0 (17.5) |
| PVC - N600 | PL/MS/ST/IL | 600 (158) | 1.2 (5.3) |
| PVC - N1000 | PL/MS | 1000 (265) | 4.0 (17.5) |

* Consumption = the flow of water and fertilizers that pass through the dosing channel.

Use the table below to formulate the appropriate combination of Venturis and dosing channels.

| Dosing channel - nominal capacity l/h (GPH) | Venturi | | | | |
|---|-------------|-----------|-----------|------------|-------------|
| | PVDF - M050 | PP - N150 | PP - M370 | PVC - N600 | PVC - N1000 |
| 50 (13) concentrated acid | + | | | | |
| 50 (13) | | + | | | |
| 150 (40) | | + | | + | |
| 400 (106) | | | + | + | |
| 600 (158) | | | | + | |
| 1000 (265) | | | | | + |



ATTENTION

The fertilizer/acid suction capacity of a dosing channel depends on suitable pressure conditions on site (see [main line pressure](#) of each mode, pages 7-13).

Compute the FertiKit total consumption (TC)

In order to assess the suitability of the selected mode or to identify the correct dosing booster pump needed for the application, it is necessary to know the FertiKit's total consumption (TC).

Typical dosing channel description and flow scheme

- 1 Motive flow = the flow of water required through the Venturi to enable suction of fertilizer/acid.
- 2 Suction flow = the flow of fertilizer/acid through the Venturi.
- 3 Total flow = motive flow + suction flow.

$$TC = \text{Total flow} * \text{Number of dosing channels}$$

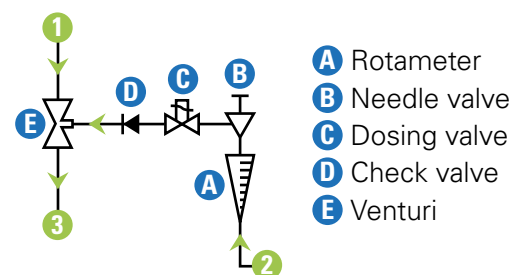

SELECTING A FERTIKIT™

Preventing damage to the dosing booster due to cavitation

If the main line pressure is lower than 1.5 bar (22 PSI) under the performance curve of the selected pump (see [performance curves](#), pages 30-33) and/or the system is installed at an altitude higher than 700 m (2300 feet) above sea level, install a PSV (Pressure sustaining valve) at the FertiKit's outlet.

To prevent the risk of damage to the EC and pH sensors:

If the main line pressure is higher than 6.5 bars (94 PSI), install a PRV (Pressure reducing valve) at the FertiKit's inlet.

For calibration of PSV and PRV see the installation manual at <http://www.netafim.com/product/fertikit-3g>.

*Cavitation - The formation of vapor cavities ('bubbles' or 'voids') in a liquid. It usually occurs when a liquid is subjected to rapid changes of pressure that cause the formation of cavities where the pressure is relatively low. When subjected to higher pressure, the voids implode and can generate an intense shockwave causing significant damage to the pump's impeller and chamber.

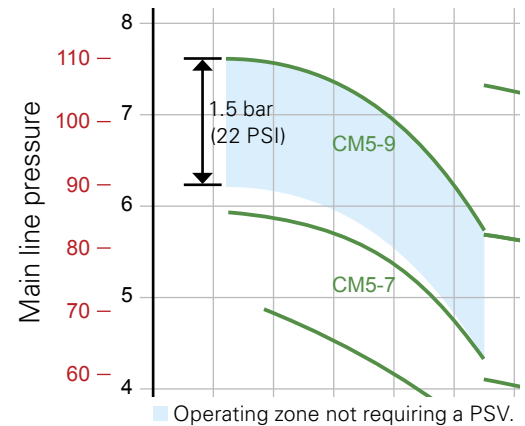

Electrical supply

To select the proper dosing channels, dosing booster, controller and accessories, it is essential to know the properties of the electricity on site.

The electricity frequency (Hz) and voltage (V) depends on the country (in some countries frequencies and voltages differ by area).



NOTE

In cases where 3-phase electricity is supplied in addition to a single phase, take note:

- The controller is single phase.
- In most cases, a 3-phase dosing booster is preferable.



TIP

If there is no electricity on site, check the possibility of operating under the PD mode fed by a 12 VDC battery (solar panel - optional), contact Netafim™.

SELECTING A FERTIKIT™

Dosing boosters

To select the dosing booster, see the appropriate graph in [appendix 2 - performance curves](#) (pages 30-33). Consult the appropriate graph according to the electricity frequency on the site and the mode you selected - **PB** or **PL, IL** or **ST** only (**PD** and **MS** do not require a dosing booster). Identify the performance curve where the pressure corresponding to the FertiKit's total consumption (TC) is at least 0.5 bar (7.25 PSI) greater than the maximum main line pressure, and select the appropriate dosing booster.



ATTENTION

Make sure that the selected dosing booster fits the electricity voltage, phases and frequency on site.

For 50 Hz installations

| Phases | Volts | Dosing booster | FertiKit's total power consumption (kW) |
|--------|---------------------|----------------|---|
| 1 | 220-240 | 5-5/1.3M | 1.45 |
| 3 | 220-240/ 380-415 | CM5-7 | 1.73 |
| | | CM5-9 | 2.35 |
| | | CM5-12 | 3.35 |
| | | CM10-3 | 2.35 |
| | | CM10-4 | 3.35 |
| | | CM10-5 | 3.35 |
| | | CM10-6 | 4.15 |
| | | CM10-8 | 5.95 |
| | | CM15-3 | 4.15 |
| | | CM15-4 | 5.95 |
| | | CM25-3 | 5.95 |
| | | CM25-4 | 7.55 |

For 60 Hz installations

| Phases | Volts | Dosing booster | FertiKit's total power consumption (kW) |
|--------|---------------------|-----------------|---|
| 1 | 220-240 | 5-3T6/1.3M | 1.45 |
| | | ST CDXM 200/206 | 1.45 |
| 3 | 208-230/ 440-480 | CM5-4 | 1.85 |
| | | CM5-5 | 2.65 |
| | | CM5-6 | 2.65 |
| | | CM5-8 | 4.15 |
| | | CM10-2 | 4.15 |
| | | CM10-3 | 4.15 |
| | | CM10-4 | 6.35 |
| | | CM10-5 | 6.35 |
| | | CM15-2 | 4.15 |
| | | CM15-3 | 6.35 |
| | | CM25-2 | 6.35 |

EC/pH control

In case of flow variations, the EC/pH control set enables the controller to perform precise fertilizer/acid optimization.

There are 2 types of EC/pH sets:

- Compatible with the NMC junior or the NMC Pro controllers.
- Compatible with the NMC XL controller via the FertMaster* terminal unit.

The options above are selectable in the FertiKit™ online configurator at <https://cmtconfig.netafim.com> (for further details, contact Netafim™).

- For other options, contact Netafim™.

***FertMaster** is the terminal unit of the NMC XL controller, used when EC/pH measurement is needed on the FertiKit™ and the NMC XL is used as an outboard controller.

As a standalone, it also offers the capacity to control the FertiKit's dosing channels and system dosing booster - a cost-effective solution where the FertiKit™ is used where there are no field valves to control

SELECTING A FERTIKIT™

(tank filling, Fertikit™ with center pivot).

Controllers

The FertiKit™ can be controlled by a variety of NMC controllers, offering many useful functions.

- The NMC Junior is the affordable option for small applications.
- The NMC Pro is the solution for mid-range to large applications.
- The NMC XL is the solution for mid-range to large applications where a single controller controls multiple dosing units, there are multiple main lines or water meters, or any of the many NMC XL exclusive features are required (contact Netafim™).
- The NMC DC is the option for applications where there is no electricity (contact Netafim™).
- In cases where the FertiKit™ is to be connected to another type of controller, contact Netafim™.



ATTENTION

Many parameters should be considered in selecting a controller for the FertiKit™, depending on various factors such as, operating method, size of the field, number of valves, distance from the controller and many more.

A comprehensive discussion on selecting a controller is beyond the scope of this document (see the NMC controllers documentation or contact Netafim™).

The NMC controllers

| Typical application | NMC-Junior | NMC-Pro | NMC-XL | NMC-DC |
|-------------------------|------------|---------|--------|--------|
| Large-scale open field | | + | + | |
| Medium-scale open field | + | + | + | + |
| Greenhouse on soil | + | + | | |
| Greenhouse on soilless | | + | | |

Controller languages

| NMC-Junior | NMC-Pro, NMC-DC | | | NMC-XL |
|---|---|--|----------------------------------|---|
| | A | B | IL | |
| English, Spanish, Italian, Japanese, French, Russian, German, Korean, Chinese | English, Spanish, Italian, Japanese, German, French, Turkish, Dutch | English, Greek, Serbian, Hungarian, Dutch, Polish, Russian | English, Spanish, French, Hebrew | English, Spanish, Italian, Turkish, Russian |

Updated - May 2015

SELECTING A FERTIKIT™

Controller features

Below are listed the basic features of the controllers, for a full list of the controllers features see the controllers literature.

| Feature | NMC-Junior | NMC-Pro | NMC-XL | NMC-DC |
|---|---------------------------|---------------------------|------------------------|---------------------------|
| Digital outputs, 24 VAC | up to 15 | up to 256 | up to 250 | |
| Digital outputs, DC latch | | | | up to 24 |
| Irrigation programs | 15 | 15 | 120 | 15 |
| External condition programs | 15 | 15 | 120 | 15 |
| ET (evapo-transpiration) trigger for irrigation | | | Yes | |
| Maximum number of valves in the system | 15 | 255 | 250 | 24 |
| Maximum number of valves running simultaneously | 15 | 40 | 30 per program | 24 |
| Maximum number of dosing programs running in parallel | 1 | 1 | 1 per line | 1 |
| Type of output, 24 VAC | Relay | Relay | Triac | Latch |
| Dry contact outputs | | Yes | | |
| Number of digital inputs | 6 | 32 | 250 | 4 |
| Number of analog inputs | 5 | 22 | 99 | 4 |
| RadioNet valve control (RTU) | | Yes | Yes | Yes |
| SingleNet valve control (RTU) | | Yes | Yes | Yes |
| Misting program by time | Yes | Yes | Yes | Yes |
| Cooling program by temperature/humidity | Yes | Yes | With condition program | Yes |
| Maximum number of supply pumps | 6 | 6 | 36 | 6 |
| Maximum number of main lines | 3 (not simultaneously) | 6 (not simultaneously) | 128 | 6 (not simultaneously) |
| Master flow meters | 3 | 6 | 100 | 6 |
| Auxiliary flow meters | 6 | 8 | 100 | 8 |
| Fertilizer flow meters | 6 | 8 | 6 (per station) | 8 |
| Control by pressure transducer | | Yes | Yes | Yes |
| Filter flushing - number of filters | 14 | 24 | 100 | 24 |
| Fertilizer programs | 10 | 10 | 120 | 10 |

General guidelines to help you select a controller

Select the basic configuration of the controller according to the number of AC outputs required to control all AC irrigation valves and local devices (the FertiKit's internal devices - dosing channels and dosing booster, and the local devices in the pump house - filter flushing, main line pumps, main line valves, etc.).

The controller can be selected in the controller online configurator at <https://cmtconfig.netafim.com> (for further details, contact Netafim™).

SELECTING A FERTIKIT™

Select the connectivity to remote units

If there are DC latch* irrigation valves, select the connectivity type according to the type of the remote units (SingleNet** or RadioNet***) with the license key that accommodates the number of remote units (up to 128 or up to 256).

***DC latch** is the operating principle of activating at a distance an hydraulic valve equipped with a solenoid.

****SingleNet** is a remote operation method to open/close DC latch valves via a 2-wire cable.

*****RadioNet** is a remote operation method to open/close DC latch valves via wireless transmission (radio frequency).

Select the PC communication



NOTE

All the above controllers can be connected to a control program on a PC (for further details, contact Netafim™).

Wired or wireless, the NMC PC communication offers many convenient features:

- Enables remote access for service and consultation.
- Enables data logging.
- Presents color graphs of the system activity history.
- Comfortable and intuitive graphic interface.

Additional controller accessories

- Power line protector
- Weather station
- Temperature and humidity measuring box
- Radiation sensor
- Communication (MUX)
- Communication card
- Cellular modem
- Voltage stabilizer and surge protector

For further details, contact Netafim™.

INSTALLATION REQUIREMENTS

Infrastructure

Each FertiKit™ mode requires a slightly different infrastructure.

The Typical installation overview on page 6 represents the typical infrastructure suitable for the **PL** mode.

The infrastructure for other modes is slightly different.

For the specific infrastructure required for the installation of each mode, see the schematic diagrams in Modes, [pages 7-13](#))

- In all the modes the distance between the inlet and the outlet of the FertiKit™ on the main line should be minimum 2 meters to allow better fertilizer mixing on the main line.
- Sufficient space should be available between the fertilizer/acid tanks and the FertiKit™ to allow inspection and maintenance operations.
- In PD mode, the pressure on the main line upstream from the PRV should be at least twice the pressure downstream from the PRV.
- In PL mode, the pressure on the main line should be minimum 2.5 bars

Infrastructure installation items

| Item | Specifications |
|--|--|
| 13 Fertilizer/acid stock tank | Between 1 and 6 fertilizer/acid solution stock tanks |
| 14 Manual valve (fertilizer) | A manual ball valve on each fertilizer/acid line at the stock tank outlet |
| 15 Fertilizer/acid filter | ≤ 130 μm (≥ 120 mesh) |
| 16 Manual valve (isolation) | To be installed at the inlet and at the outlet of the FertiKit™, for use during system maintenance. |
| 17 Main line pressure sustaining valve (PSV) | To be installed on the main line downstream from the FertiKit™ and able to sustain a constant pressure at the outlet of the FertiKit™, regardless of pressure changes in the field. Should be calibrated to 3-4 bars (43-58 PSI) for most projects. |
| 18 Irrigation valve | Controllable. |
| 19 Water meter | With electrical pulses. The pulse should be as short as possible according to the main line diameter and the controller's limitations. (See Flow meter recommended pulse rate table, page 24.) |
| 20 Main line filter | ≤ 130 μm (≥ 120 mesh). |
| 21 Main line pump | Suitable for the required pressure and flow rate according to the mode of the FertiKit™ and the field requirements (Ensure stable pressure). |
| 22 Main line pressure reducing valve (PRV) | In the PB or PL mode - Should be installed on the main line, between the main line filters and the water meter and be able to reduce the main line pressure as specified for PL or PB modes (pages 7-8). In PD mode only - Should be installed on the main line, between the inlet and the outlet of the FertiKit™ and be able to reduce the main line pressure as specified for the PD mode (page 13). |
| 23 Sampling outlet | In PD mode only - Should be installed on the main line, downstream from the FertiKit's outlet (in all other modes the sampling outlet is built-in). |
| 24 Saddle fitting | In PD mode only - Should be installed on the main line, downstream from the FertiKit's outlet, equipped with an outlet suitable for the EC/pH sampling tube. |
| 25 Command tube | In PD mode only - Should connect the saddle fitting to the EC/pH sampling tube. |

INSTALLATION REQUIREMENTS

Flow meter recommended pulse rate for NMC Pro and Junior controllers*

| Flow rate m ³ /h | Flow meter output l/pulse |
|--------------------------------|------------------------------|
| Up to 6 | 1 |
| 6 - 60 | 10 |
| 60-600 | 100 |

| Flow rate GPM | Flow meter output US gal/pulse |
|------------------|-----------------------------------|
| Up to 88 | 1 |
| 88 - 1000 | 10 |
| 1000-4500 | 100 |

*Users of NMC XL controller and FertMaster, see the relevant product manual.

Electrical installation

An electrical mains installation including a circuit breaker, complying with the local safety standards and regulations should be supplied in accordance with the FertiKit's power consumption requirements.

FertiKit's power consumption (kW)

- All FertiKit™ configurations without a dosing booster (**PD** or **MS** modes) consume under 150 W.
- In **PB**, **PL**, **IL**, **ST** or **SP** modes, the FertiKit's total power consumption depends mainly on the consumption of the dosing booster (see [Dosing boosters](#), page 19).

Flow rate stability

Ensure that the pressure and flow requirements of the individual irrigation shifts are as equal as possible. Each changeover between shifts with different requirements will result in pressure and/or flow fluctuation, affecting the EC and pH stability. **The smallest shift should not be less than 75% of the largest shift.**

Source water

- The water entering the FertiKit™ 3G should be within a temperature range of 10°C and 35°C (50°F and 95°F).
- The source water to the FertiKit™ 3G should be of a satisfactory chemical quality. If water pre-treatment is required, apply chemical conditioning before the water reaches the FertiKit™ 3G:

Source water quality (High bicarbonate levels)

FertiKit™ 3G is specially designed for Fertigation™ in the medium tech sector, using a substrate of high water retention or/and volume, the pulse duration is 3-5 min, so source water with a bicarbonate (HCO₃) content of up to 4 meq/l can be used in the FertiKit™ 3G without acid pre-treatment.

Adding high concentration of fertilizers to water with a high bicarbonate (HCO₃) content may create low-solubility salts in the solution, that reduces Fertigation™ efficiency and may cause clogging of filters and drippers. This is why it is recommended not to use water with bicarbonate (HCO₃) content higher than 4 meq/l.

When the bicarbonate (HCO₃) content is higher than the required level, a pre-acidification of the source water is recommended. In this process the incoming water is brought to a mild acid pH level of approx. 6.0 prior to its storage in a day-storage tank. This process can be performed by an additional FertiKit™ fitted with the appropriate features (Contact Netafim™). The acid applied will neutralize the bicarbonate (HCO₃) in the storage tank by means of a chemical reaction and the carbon dioxide (CO₂) will be released from the source water. Aerating or spraying the acidified water to the storage tank will improve the discharge of CO₂, accelerating the neutralization process.



NOTE

A full analysis of the water is recommended. In case of doubt, consult a Netafim™ expert.

DIMENSIONS AND WEIGHTS

Dimensions

With controller

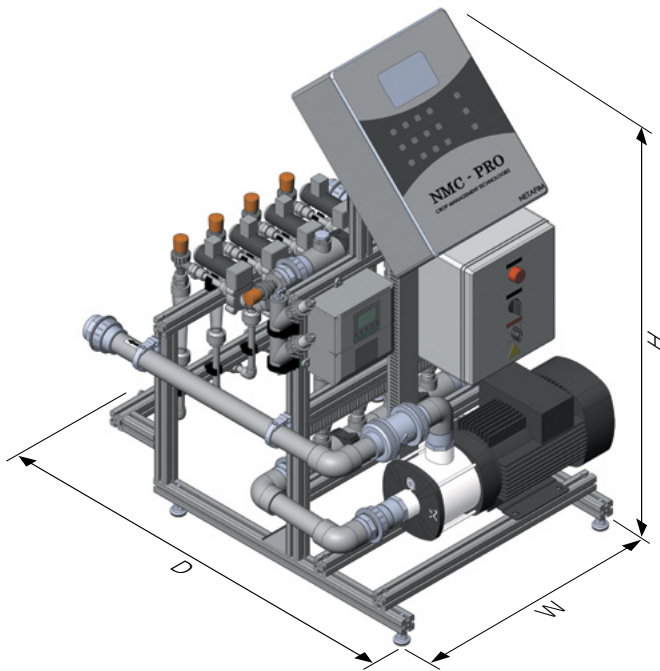

Without controller

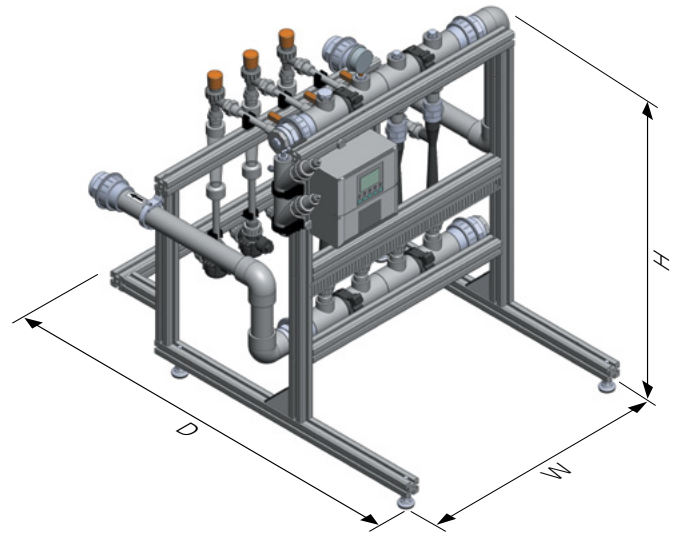

| Configuration | FertiKit™ external dimensions (W/D/H*) | Package dimensions (W/D/H**) |
|--------------------|--|--------------------------------|
| Without controller | 84/103/92 cm (33/40.5/36") | 103/117/100 cm (40.5/46/39.5") |
| With controller | 84/103/134.5 cm (33/40.5/53") | 103/117/154 cm (40.5/46/60.5") |

*The height varies by ± 1 cm (± 0.5 " according to the adjustment of the legs.

**The package height includes the pallet height of 15 cm (6").

Weights

FertiKit™ with dosing booster

| Controller | Matrix 5 | | CM5 | | CM15 | |
|------------|----------------------|----------------------|----------------------|-----------------------|-----------------------|-----------------------|
| | Net weight | Packed weight | Net weight | Packed weight | Net weight | Packed weight |
| Without | 60 kg. (132 lbs.) | 85 kg. (187 lbs.) | 73 kg. (161 lbs.) | 98 kg. (216 lbs.) | 100 kg. (220 lbs.) | 125 kg. (276 lbs.) |
| With | 70 kg. (154 lbs.) | 98 kg. (216 lbs.) | 83 kg. (183 lbs.) | 111 kg. (245 lbs.) | 110 kg. (243 lbs.) | 138 kg. (304 lbs.) |

For the weight of FertiKit™ units with other dosing boosters, contact Netafim™.

FertiKit™ without dosing booster

| Controller | Net weight | Packed weight |
|------------|-------------------|-------------------|
| Without | 43 kg. (95 lbs.) | 68 kg. (150 lbs.) |
| With | 53 kg. (117 lbs.) | 81 kg. (179 lbs.) |

The weights in the tables above are order of magnitude only - final data are issued with the product order.

DIMENSIONS AND WEIGHTS

Location of inlet, outlet and fertilizer/acid line connectors

All modes except PB and SP

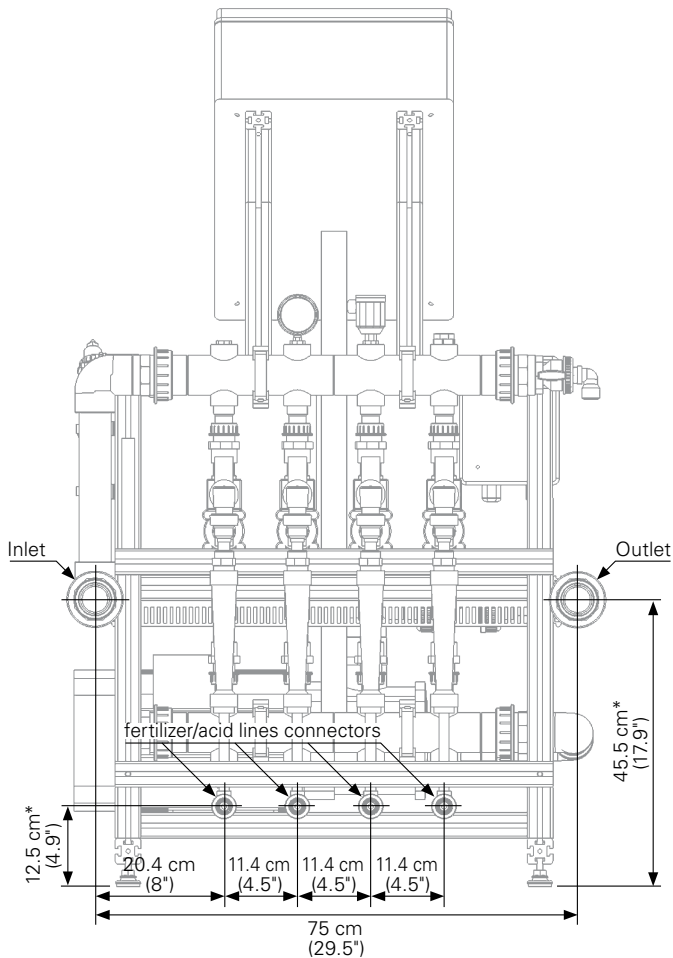

PB mode (SP mode**)

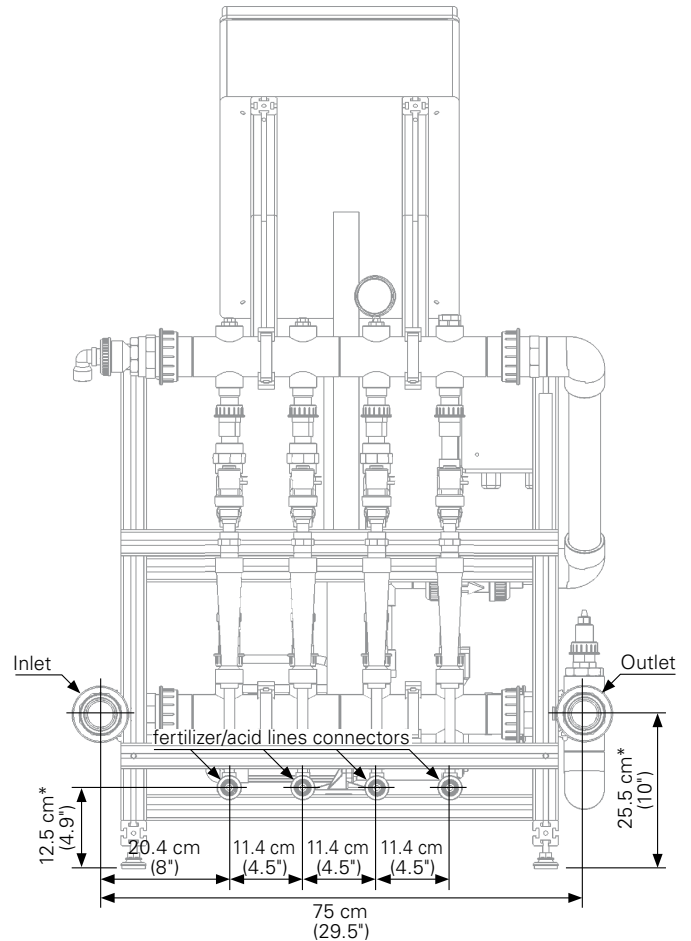

*The height varies by ± 1 cm (± 0.5 ") according to the adjustment of the legs.

**The SP mode is equipped with a separate outlet for each dosing channel (see [page 9](#))

Fertilizer and acid line connection types

| Fittings (interchangeable) | Diameter |
|--|----------|
| PVC, hose nozzle insert connector (installed) | 16 mm |
| PVC, nipple - male thread connector (supplied) | 1/2" |
| PVC, half union - female thread connector (supplied) | 3/4" |

Inlet and outlet connection types

| Fittings (interchangeable) | Diameter |
|---|----------|
| PVC, adaptor union - glue connector (installed) | 50 mm |
| PVC, BSP or NPT nipple - male thread connector (supplied) | 1.5" |

SAFETY AND WARRANTY

Safety

- All safety regulations must be applied.
- Ensure that the installation is carried out in a manner that prevents leaks from the FertiKit™, the fertilizer/acid tanks and lines, the peripherals and the accessories (contaminating the environment, soil or ambient area).
- When using acid always observe the acid manufacturer's safety instructions.
- Use protective equipment, shoes, gloves and goggles when handling fertilizers, acid and other chemicals!
- Electrical installation should be performed by an authorized electrician only.
- The electrical installation must comply with the local safety standards and regulations.
- Installation should be performed by authorized technicians only.
- Protection provided by the equipment can be impaired if the equipment is used in a manner other than that specified by the manufacturer.



ACID HAZARD

When using acid - always observe the acid manufacturer's safety instructions.



WARNING

Always use protective equipment, gloves and goggles when handling fertilizers, acid and other chemicals!



WARNING

Measures must be taken to prevent fertilizer infiltration of the water source, to avoid water pollution.



NOTE

The maximum sound level produced by the equipment does not exceed 70dB.

SAFETY AND WARRANTY

Warranty

Netafim™ warrants all the components of the FertiKit™ to be free of defects in material and workmanship for 1 (one) year from the date of installation, provided the installation has been reported to Netafim™ within 30 days of installation.

If the installation was not reported or was reported later than 30 days from the date of installation, Netafim™ will warrant the FertiKit™ for a period of 18 months from the date of production, according to its serial number.

If a defect is discovered during the applicable warranty period, Netafim™ will repair or replace, at its discretion, the product or the defective part.

The above does not apply to EC and pH sensors, since they are considered perishable items. Netafim™ will warrant these items to be free of defects in material and workmanship for 3 months from the date of installation, provided the installation has been reported to Netafim™ within 30 days, or 6 months from date of production if installation was not reported or was reported later than 30 days from the date of installation.



NOTE

When not installed, the pH sensor must be immersed in KCL solution (pH \approx 4.0) at all time, protected from freezing and not be exposed to pressure greater than 6 bars (87 PSI). Damage due to these causes is not covered by warranty.

This warranty does not extend to repairs, adjustments or replacements of a FertiKit™ or part that results from misuse, negligence, alteration, force majeure, lightning, power surge, improper installation or improper maintenance.

If a defect arises in your Netafim™ product during the warranty period, contact your Netafim™ supplier.

Limited Warranty

This warranty is subject to the conditions in Netafim's official warranty statement. (For the full text of Netafim's official warranty statement, please contact Netafim™).



DECLARATION OF CONFORMITY

Manufacturer's Name: NETAFIM LTD.
Manufacturer's Address: 10 DERECH HASHALOM, TEL AVIV 67897, ISRAEL

MODEL No.: **FERTIKIT 3G 3-Phase**
FERTIKIT 3G Single Phase
FERTIKIT 3G Manual

DESCRIPTION OF EQUIPMENT:

FertiKit- Nutrient Fertilizer, Acid and Alkaline Dosing System

Year of Equipment: **2013**

DIRECTIVE COMPLIED WITH: **EMC:** 2006/95/EC
LVD: 2008/108/EC

Harmonized Standards to which
Conformity is Declared:

EN 55011:2009+A1:2010
EN 61000-6-1:2007
ICE 61000-4-2:2008+A1:2010
ICE 61000-4-6:2008
ICE 61000-4-11:2004
ICE 61000-4-4:2004
EN61010-1: 2010

We, the undersigned hereby declare that the equipment specified above conforms to the above Directive and Standards.

Manufacturer:

Date: 12/2/2013

Full Name: Avi Schweitzer

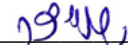
Signature: 

Position: VC of R&D, NETAFIM LTD.

EU Authorized Representative:

Date: 14.2.13

Full Name: Alon Shimoni

Signature: 

Position: CEO, NETAFIM Deutschland GmbH.

NETAFIM Deutschland GmbH
Innovative Bewässerung
Im Fuchsloch 7
60437 Nieder Erlenbach
Telefon 06101 / 50510

NETAFIM –Crop Management Technologies

10 DERECH HASHALOM, TEL AVIV 67897, ISRAEL T +972-8-6474747 F +972-8-6473983 WWW.NETAFIM.COM

APPENDIX 1

FertiKit™ performance curves for selection of the dosing booster

PL mode*, 50 Hz

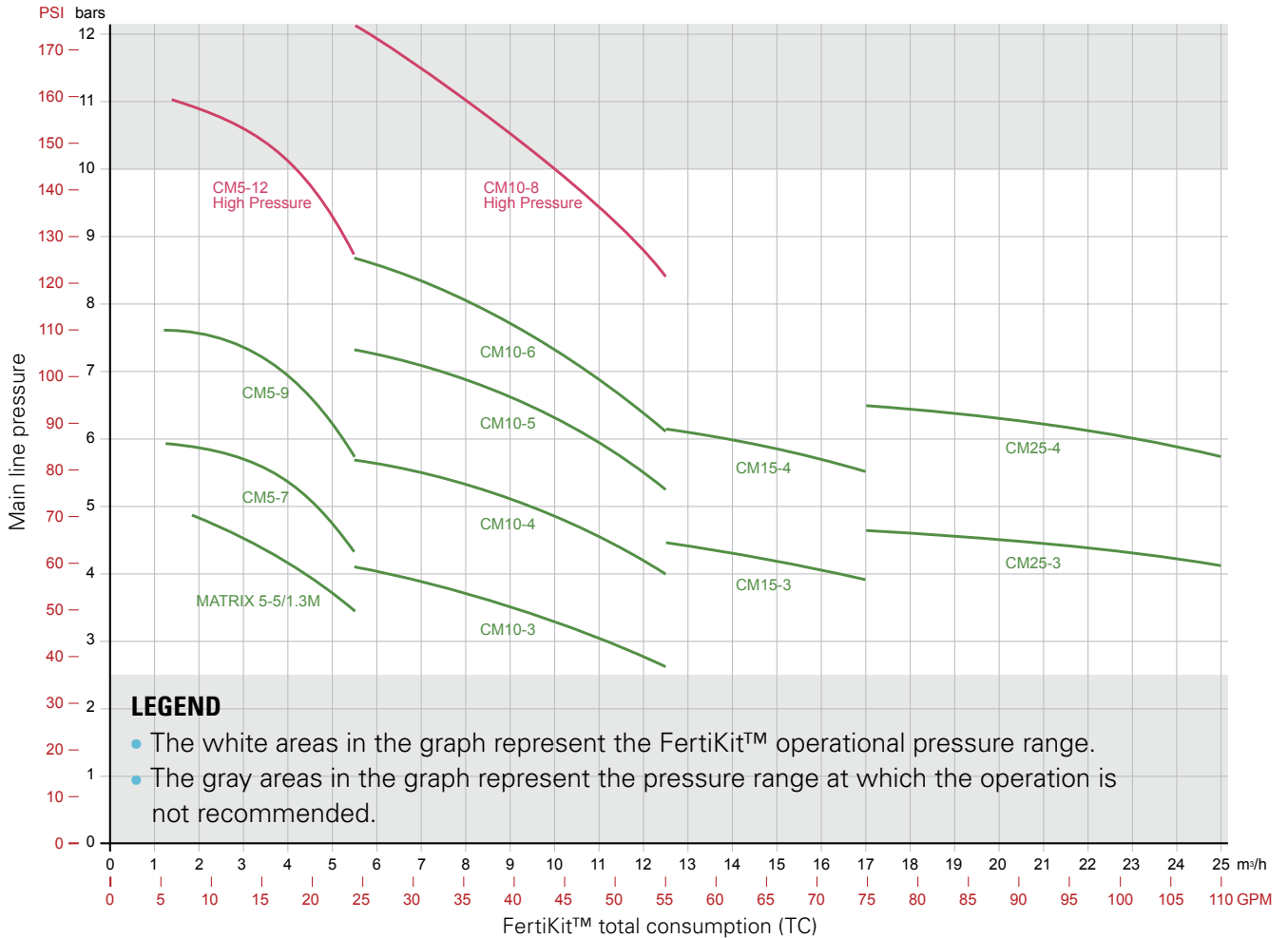

* When selecting the dosing booster for PB mode, see the data on [page 8](#).



NOTE

The curves above represent the performance of the FertiKit™ and thus are different from the performance curves presented in the literature issued by the pump manufacturers.

Typical consumption of Venturis

A complete line of Venturis is available to accommodate various flow rates of fertilizer or acid.

| Venturi | Applicable for mode | Nominal suction flow - l/h (GPH) | Typical consumption** - m³/h (GPM) (at pressure up to 5 bars) |
|-------------|---------------------|----------------------------------|---|
| PVDF - M050 | Any mode | 50 (13) | 1.0 (4.4) |
| PP - N150 | Any mode | 150 (40) | 1.2 (5.3) |
| PP - M370 | SP/PB/PD | 370 (98) | 4.0 (17.5) |
| PVC - N600 | PL/MS | 600 (158) | 1.2 (5.3) |
| PVC - N1000 | PL/MS | 1000 (265) | 4.0 (17.5) |

** Consumption = the flow of water that needs to pass through the Venturi to enable nominal suction. See [Compute the FertiKit™ total consumption \(TC\)](#), page 17.

APPENDIX 1

FertiKit™ performance curves for selection of the dosing booster

PL mode*, 60 Hz

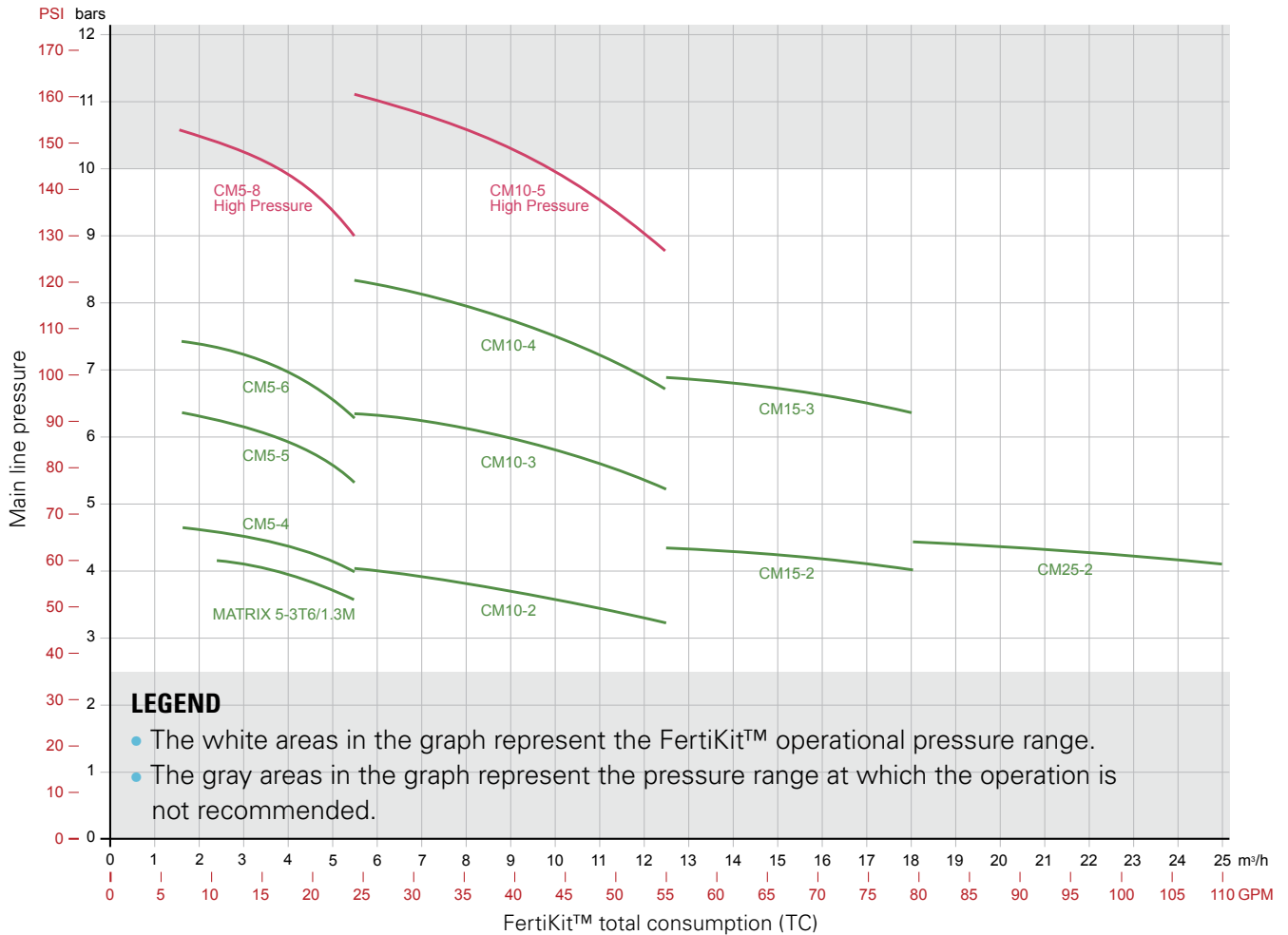

* When selecting the dosing booster for PB mode, see the data on [page 8](#).



NOTE

The curves above represent the performance of the FertiKit™ and thus are different from the performance curves presented in the literature issued by the pump manufacturers.

Typical consumption of Venturis

A complete line of Venturis is available to accommodate various flow rates of fertilizer or acid.

| Venturi | Applicable for mode | Nominal suction flow - l/h (GPH) | Typical consumption** - m³/h (GPM) (at pressure up to 5 bars) |
|-------------|---------------------|----------------------------------|---|
| PVDF - M050 | Any mode | 50 (13) | 1.0 (4.4) |
| PP - N150 | Any mode | 150 (40) | 1.2 (5.3) |
| PP - M370 | SP/PB/PD | 370 (98) | 4.0 (17.5) |
| PVC - N600 | PL/MS | 600 (158) | 1.2 (5.3) |
| PVC - N1000 | PL/MS | 1000 (265) | 4.0 (17.5) |

** Consumption = the flow of water that needs to pass through the Venturi to enable nominal suction. See [Compute the FertiKit™ total consumption \(TC\)](#), page 17.

APPENDIX 1

FertiKit™ performance curves for selection of the dosing booster

ST mode*, 50 Hz

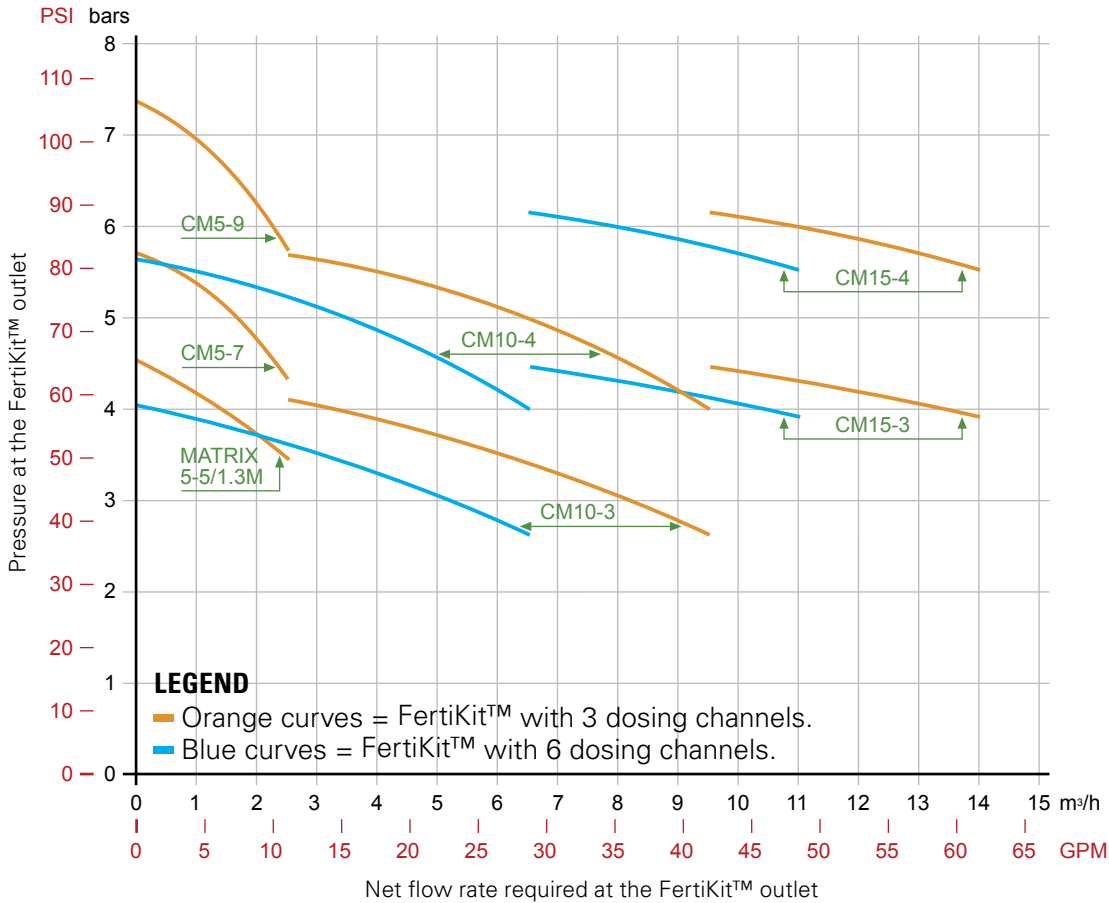

NOTE

The curves above represent the performance of the FertiKit™ and thus are different from the performance curves presented in the literature issued by the pump manufacturers.

Venturis

A complete line of Venturis is available to accommodate various flow rates of fertilizer or acid. In the ST mode the typical consumption of the Venturi of each dosing channel is 1.0 m³/h (4.4 GPM).

| Venturi | Nominal suction flow - l/h (GPH) |
|-------------|----------------------------------|
| PVDF - M050 | 50 (13) |
| PP - N150 | 150 (40) |
| PVC - N600 | 600 (158) |

APPENDIX 1

FertiKit™ performance curves for selection of the dosing booster

ST mode*, 60 Hz

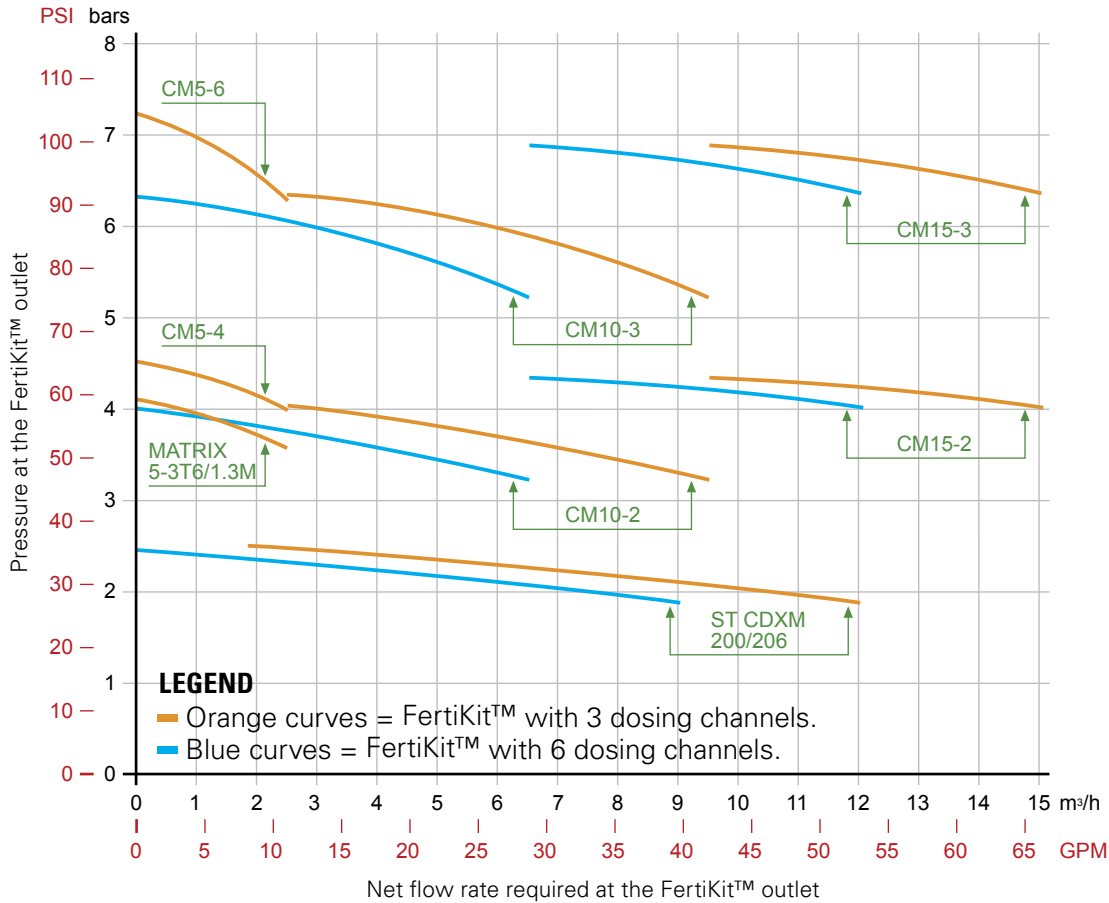

NOTE

The curves above represent the performance of the FertiKit™ and thus are different from the performance curves presented in the literature issued by the pump manufacturers.

Venturis

A complete line of Venturis is available to accommodate various flow rates of fertilizer or acid. In the ST mode the typical consumption of the Venturi of each dosing channel is 1.0 m³/h (4.4 GPM).

| Venturi | Nominal suction flow - l/h (GPH) |
|-------------|----------------------------------|
| PVDF - M050 | 50 (13) |
| PP - N150 | 150 (40) |
| PVC - N600 | 600 (158) |

APPENDIX 2

FertiKit™ summary of combinations

| Mode | Operating principle | Flow rate | Required main line pressure | Upper manifold pressure | Lower manifold pressure | Additional conditions | Dosing channels | EC/pH |
|------|---|----------------------------------|--|---|--|---|---|--|
| PL | The pressure differential required to generate fertilizer suction via the Venturis is produced by a dosing booster integrated in the FertiKit™. | 20 - 700 m³/h (85 - 3000 GPM) | 2.5 - 6.5 bars (36 - 94 PSI). | | -0.5 - +0.8 bar (-7 - +12 PSI) Based on cavitation risk (see page 18) | | Up to 6 x 50 - 1000 l/h (13 - 250 GPH) (Concentrated acid channel, 50 l/h (13 GPH) - optional) | Single, control and monitoring |
| | | | Based on cavitation risk (see page 18) | | | | | |
| | | | 6.5 - 8.5 bars (94 - 123 PSI) | Set PRV to 3.5 - 4.5 bars (50 - 65 PSI) | | | | |
| | | | 2.5 - 8.5 bars (36 - 94 PSI) | | | | | |
| IL | This mode of operation, where the lower manifold is at low pressure (around 0 bars), permits the use of high-efficiency Venturis with high suction capacity and low motive flow. | 3 - 18 m³/h (13 - 85 GPM) | 2.5 - 5.5 bars (36 - 79 PSI) | | | Up to 6 x 50 - 600 l/h (13 - 156 GPH) (Concentrated acid channel, 50 l/h (13 GPH) - optional) | | |
| MS | Utilizes the main line pump pressure. Saves the need for a dosing booster. | 20 - 700 m³/h (85 - 3000 GPM) | At the FertiKit's inlet -0.3 - +0.6 bar (-4 - +9 PSI) | Without EC and pH sensors: 2.5 - 6.5 bars (36 - 94 PSI). | Equal to the main line pressure at the FertiKit's inlet: -0.3 - +0.6 bar (-4 - +9 PSI) | Possibility of connection to the main line upstream from the pump. The main line pump is able to deliver the flow rate required for the operation of the FertiKit™ + the field consumption. | Up to 6 x 50 - 1000 l/h (13 - 250 GPH) (Concentrated acid channel, x 50 l/h (13 GPH) - optional) | Single, control and monitoring |
| | | | | With EC and pH sensors: 2.5 - 6.0 bars (36 - 87 PSI) | | | | |
| RS | | | | At the pump outlet 5.5 - 8.5 bars (80 - 123 PSI) | | | | |
| ST | The main line pump is integrated in the FertiKit™ and serves also as a dosing booster. | 1 - 16 m³/h (4.4 - 70 GPM) | | At the pump outlet: 2.0 - 5.5 bars (29 - 80 PSI) | | Pump flow (m³/h) = field flow + TC (1 X No. of dosing channels) See TC , page 17. | Up to 6 x 50 - 600 l/h (13 - 150 GPH) (Concentrated acid channel, x 50 l/h (13 GPH) - optional) | |
| SP | The pressure differential required to generate fertilizer suction via the Venturis is produced by a booster pump integrated in the FertiKit™. This mode of operation, where the system pump is installed upstream from the Venturis, permits the use of a smaller pump, reducing the investment required and saving energy. This mode is suitable for relatively low flow rates and pressures. | 5 - 70 m³/h (22 - 300 GPM) | 1.5 - 2.5 bars (22 - 36 PSI) | 5.5 - 6.5 bars (80 - 94 PSI) The Δ of 4.0 bars (58 PSI) is supplied by the integrated dosing booster | | The pressure supplied by the dosing booster is added to the main line pressure. Their sum should not exceed 6.5 bars (94 PSI) | Up to 4 x 50 - 370 l/h (13 - 100 GPH) (Concentrated acid channel, x 50 l/h (13 GPH) - optional) | Single, control and monitoring |
| | | | | | 1.0 - 2.5 bars (14 - 36 PSI) | | | |
| PD | Utilizes the main line pressure. Applicable also where there is no electricity on the site (contact Netafim™). Saves the need for a dosing booster. | 10 - 200 m³/h (44 - 880 GPM) | 4.5 - 8.0 Bars (65 - 116 PSI) | The pressure in the upper manifold ≥ X2 the pressure in the lower manifold | | For the dosing channels to provide proper suction the pressure downstream from the PRV should be at least 50% the pressure upstream from the PRV (The suction provided by the dosing channels decreases as the pressure downstream from the PRV lowers compared to the pressure upstream from the PRV). In addition the system must supply sufficient pressure for the field consumption. | Up to 4* x 50 - 370 l/h (13 - 100 GPH) (Concentrated acid channel x 50 l/h (13 GPH) - optional) *If EC/pH is installed it occupies the location of one dosing channel. | None (Single monitoring only - optional) |

APPENDIX 3

List of configurator items

F3 PL -3 E 60 +1 D40 -50H 400 CM59 EH -16 P2 -485 -FM
A B C D E F G H I J K L M N O

A FertiKit™ 3G

B Mode

| Code | Description | |
|------|-----------------------------|---|
| PL | PL | |
| | PR | PL with PRV (for high pressure) |
| | PS | PL with PSV (for low pressure) |
| | RL | PL with PRV & PSV |
| PB | PB | |
| MS | MS | |
| | RS | MS with PRV |
| IL | IL- (inline, up to 20 m³/h) | |
| PD | PD | |
| SP | Split (USA & Peru) | |
| ST | STM | ST with manual filter (up to 16 m³/h) |
| | STS | ST with semi automatic filter (up to 16 m³/h) |

C Number of fertilizer channels

(Fertilizer only, excluding acid)

| Code | Description |
|------|----------------------------|
| N/A | No channel for fertilizer |
| -1 | 1 channel for fertilizers |
| -2 | 2 channels for fertilizers |
| -3 | 3 channels for fertilizers |
| -4 | 4 channels for fertilizers |
| -5 | 5 channels for fertilizers |
| -6 | 6 channels for fertilizers |

D Dosing channel operator

| Code | Description |
|------|------------------------------------|
| N/A | No channel for fertilizer |
| E | Electric (standard) |
| U | Electric (S12) |
| H | Hydraulic |
| M | Manual |
| CF | Electric - concentrated fertilizer |

E Fertilizer channel flowrate

| Code | Description |
|------|---------------------------|
| 100 | 1000 l/h |
| 60 | 600 l/h |
| 40 | 400 l/h |
| 37 | 370 l/h |
| 15 | 150 l/h |
| 05 | 50 l/h |
| N/A | No channel for fertilizer |

F Number of acid channels

| Code | Description |
|------|---------------------|
| N/A | No channel for acid |
| +1 | 1 channel for acid |
| +2 | 2 channel for acid |
| +3 | 3 channel for acid |
| +4 | 4 channel for acid |
| +5 | 5 channel for acid |
| +6 | 6 channel for acid |

G Acid channel

| Code | Description |
|------|-------------------------------------|
| D60 | Diluted acid 600 l/h |
| D40 | Diluted acid 400 l/h |
| D37 | Diluted acid 370 l/h |
| D15 | Diluted acid 150 l/h |
| D05 | Diluted acid 50 l/h |
| SA05 | Concentrated acid 50 l/h S12 |
| SA15 | Concentrated acid 150 l/h S12 |
| CA05 | Concentrated acid 50 l/h (Baccara) |
| CA15 | Concentrated acid 150 l/h (Baccara) |
| N/A | No channel for acid |

H Frequency

| Code | Description |
|------|-----------------------------|
| -50H | 50Hz |
| -60H | 60Hz |
| N/A | No frequency (DC or manual) |

I Voltage

| Code | Description |
|-------|--|
| 12VDC | 12 VDC |
| 24VAC | 24VAC |
| 400 | 3x400 - 440V (Europe, Africa, Middle East, Australia, India, China) |
| 440 | 3x400 - 440V (USA, Mexico, Peru, Korea, Brazil) |
| 220 | 3x220V (USA, Mexico, Central America, Colombia) |
| 200 | 3x200V (Japan) |
| 1X220 | 1x220V |
| 1X110 | 1x110V |
| N/A | Manual |

J Pump type

| Code | Description |
|-------|--------------------------------------|
| CM54 | Grundfos CM5-4 |
| CM55 | Grundfos CM5-5 (60Hz) |
| CM56 | Grundfos CM5-6 |
| CM57 | Grundfos CM5-7 |
| CM58 | Grundfos CM5-8 (60Hz High pressure) |
| CM59 | Grundfos CM5-9 |
| CM512 | Grundfos CM5-12 (50Hz High pressure) |
| CM102 | Grundfos CM10-2 |
| CM103 | Grundfos CM10-3 |
| CM104 | Grundfos CM10-4 |
| CM105 | Grundfos CM10-5 |
| CM106 | Grundfos CM10-6 |
| CM108 | Grundfos CM10-8 |
| CM152 | Grundfos CM15-2 |
| CM153 | Grundfos CM15-3 |
| CM154 | Grundfos CM15-4 (Standard for 50Hz) |
| CM252 | Grundfos CM25-2 |
| CM253 | Grundfos CM25-3 (60Hz) |
| CM254 | Grundfos CM25-4 |
| MTX53 | Ebara Matrix 5-3T (single phase) |
| MTX55 | Ebara Matrix 5-5T (single phase) |
| CD22 | Ebara CDXM 200/206 60HZ |
| N/A | No pump |

K EC/pH measurement

| Code | Description |
|------|---------------------------------|
| EH | Single EC/pH |
| EC | Single EC |
| PH | Single pH |
| F1 | EC/pH interface for NMC XL 110V |
| F2 | EC/pH interface for NMC XL 220V |
| N/A | None |

L Number of outputs

| Code | Description |
|------|----------------------------|
| -8 | 8 outputs |
| -15 | 15 outputs 24V AC (Junior) |
| -16 | 16 outputs |
| -24 | 24 outputs |
| -32 | 32 outputs |
| -40 | 40 outputs |
| -48 | 48 outputs |
| -56 | 56 outputs |
| -64 | 64 outputs |
| N/A | Without controller |

M Controller

| Code | Description |
|------|---|
| P2 | NMC-Pro 230V |
| P1 | NMC-Pro 115V |
| P4 | NMC-Pro 230V - double door |
| P3 | NMC-Pro 115V - double door |
| J2 | NMC-Junior 230V |
| J1 | NMC-Junior 115V |
| J4 | NMC-Junior 230V - double door |
| J3 | NMC-Junior 115V - double door |
| K2 | NMC-Pro 230V - Korean & Chinese |
| JC2 | NMC-Junior 230V - Chinese |
| JK2 | NMC-Junior 230V - Korean |
| DC | NMC DC |
| -SSR | Solid state relays for the dosing channel (no controller) |
| -WOC | Without controller |

N Communication port

| Code | Description |
|------|---|
| -485 | RS-485 (parallel) communication card |
| -EXP | Dual RS-485 for expansion box |
| -232 | RS-232 (serial) communication card |
| -SN1 | Singlenet with license key 128 (including host & SLSM*) |
| -SN2 | Singlenet with license key 256 (including host & SLSM*) |
| -128 | Radionet with license key 128 (excluding host**) |
| -256 | Radionet with license key 256 (excluding host**) |
| N/A | None |

*SLSM: SingleNet Lightning Suppression Module

**Host: Interface card between the NMC Pro and SingleNet

O Special configuration

| Code | Description |
|------|-----------------------------|
| N/A | None |
| -FM | Fertilizer meters - liters |
| -FG | Fertilizer meters - gallons |

APPENDIX 4

On-line configurator

To receive a quote or find the catalogue Number for a selected FertiKit™ configuration - after selecting the FertiKit™, go to <https://cmtconfig.netafim.com>.

In the on-line configurator:

- Follow the instructions
- Send the resulting string to Netafim™.



ATTENTION

Not every configuration of the FertiKit™ is practicable.

Do not use the List of configurator items on the previous page to build a FertiKit™ configuration.

To avoid unpracticable configurations, always use the on-line configurator.

APPENDIX 5

Dosing ratio estimates



WARNING

These are only estimates - for the exact fertilizer dosing ratio in a given project, consult an agronomist.

Irrigation according to the water consumption of the crop

| Crop | Dosing ratio per channel (l/m ³) (US gal/1000 US gal) | |
|---|--|--------|
| | Type 1 | Type 2 |
| Open Field | | |
| Carrot | 1 | 2.5 |
| Corn / Maize | 2 | 5 |
| Cotton | 2 | 5 |
| Flowers | 3 | 5 |
| Industrial tomato | 1 | 2.5 |
| Onion | 2 | 5 |
| Plantations (Tea, coffee, citrus, avocado, almonds, pecan nuts) | 1 | 2.5 |
| Potato | 1 | 2.5 |
| Sorghum | 1 | 2.5 |
| Sugar cane | 1.5 | 3 |
| Vegetables | 3 | 5 |
| Watermelon | 1 | 2.5 |
| Protected Crops (greenhouse) | | |
| Vegetable in soil (A+B+acid) | 5 | |
| Flowers in soil (A+B+acid) | 5 | |
| Vegetable in soil (A+B+C+D+acid) | 3.5 | |
| Flowers in soil (A+B+C+D+acid) | 3.5 | |
| Vegetable in substrate | 5 | |
| Flowers in substrate | 5 | |
| Vegetable in substrate (High-Tech greenhouse - Multi-pulse**) | 10 | |
| Flowers in substrate (High-Tech greenhouse - Multi-pulse**) | 10 | |

Type 1: Normal irrigation/nutrigation - Usually out of the rainy season, where a lower fertilizer dosing ratio is required.

Type 2: Technical Nutrigation - Usually during rainy seasons, where a small quantity of irrigation water is required for application of the fertilizer.

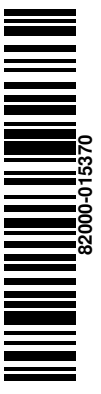

GROW MORE WITH LESS

WWW.NETAFIM.COM