

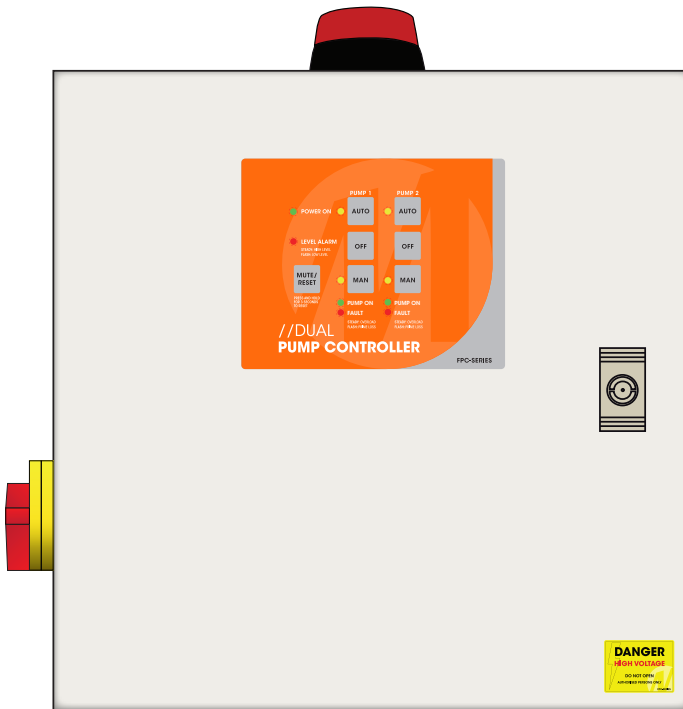

DUAL PUMP CONTROL

# SPECIFICATION'S AND OPERATOR MANUAL



# INSTALLATION

## MOUNTING

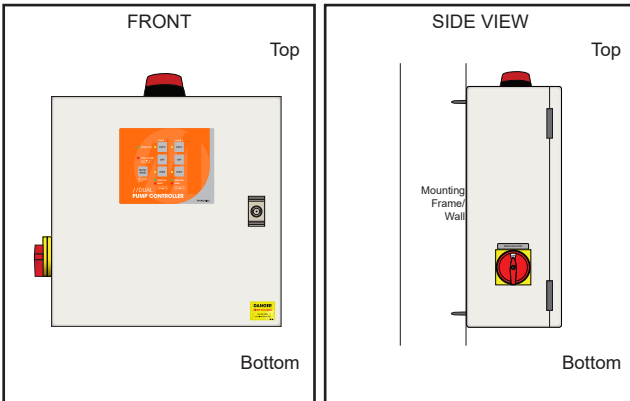

1. Controller enclosure must be mounted in a vertical position.
2. Ensure mounting method does not compromise enclosure weather proof rating.
3. Ensure access to main isolator is not restricted.
4. Ensure cables/conduits entering the panel have mechanical protection and that the penetrations are sealed and do not compromise the weather proof rating of the enclosure.

## CONNECTION

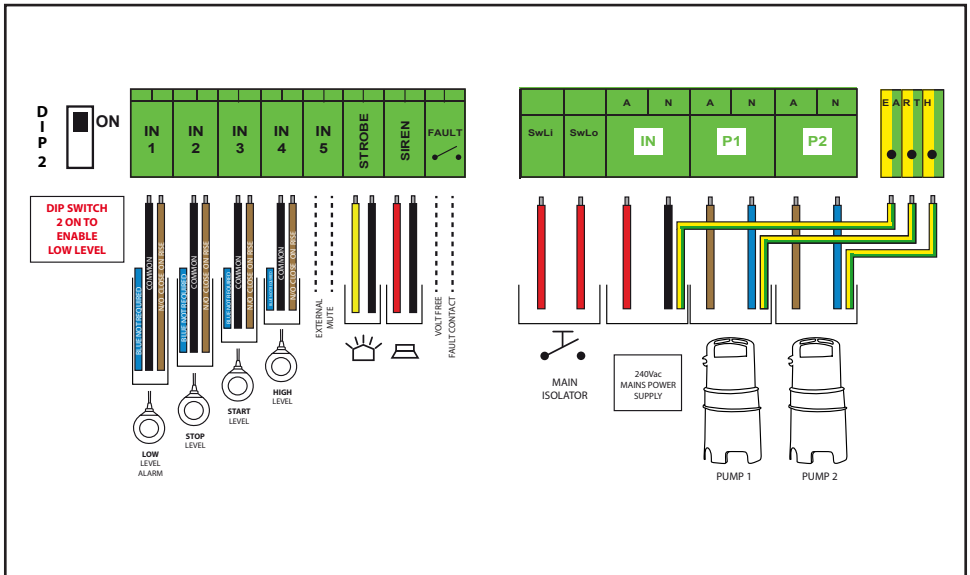

**Note:** Controller must be earthed and all electrical connections must be carried out by a suitably qualified Electrician. For Single Working Level Float Switch Applications, connect to “Start (Input 3)” terminals only, and NO bridge wire is required in “Stop (Input 2)” terminals.

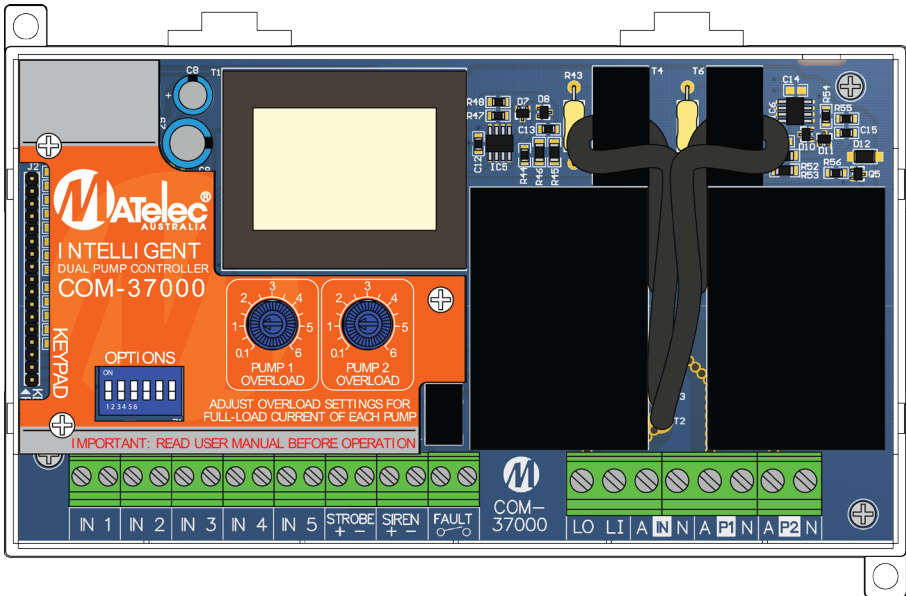

# FEATURES

The COMPAKT dual pump controller is as the name indicates, it is compact. It has all the features of the APC6 dual pump controller and is suited to most applications. The COMPAKT is an off the shelf ready to go product in two ranges, 0.1-6amp and 5-16amp. Being compact there is no capacity to add additional features such as a HMI, specific BMS, telemetry or additional pumps. This is the flexibility of the APC6 Dual Pump Controller.

The following features are included in the COMPAKT control:

- 5x Digital inputs arranged as screw terminals.
- 2x 230Vac Pump outputs. Using a heavy duty relay capable of switching pumps up to 1.5kW.
- Current monitoring of pumps for detection of overload and subsequent shutoff.
- 2x 12Vdc outputs for siren and strobe. Protected from overload by a current sensing circuit.
- 1x Voltage free normally open 'common fault' output (rated to 24VDC, 1A).
- 1x Dual Pump Keypad Interface
- 1x External mute button input (IN5 input screw terminals).
- DIP switches to select:
  - Operation mode
  - Alternation time
  - Anti-seize protection
  - 5 minute manual timeout
  - High level options

# POWER

The controller is supplied from single-phase, 230Vac mains with a tolerance of  $\pm 10\%$ . Maximum power draw of the controller itself is 10W.

# CONNECTIONS

The following is an overview of all signals and connections to the device. The extra low voltage terminals are completely isolated from the mains supply using a step-down transformer. The ELV section of the controller operates on 5V and 12V

## Inputs

The device has 5 inputs, each which presents a 1.2k $\Omega$  impedance from a 12V nominal source. The controller samples the inputs at 100Hz and then filters them to the 10Hz main operating speed. Note that the inputs are not optically isolated and therefore care must be taken if connecting these to anything other than voltage free contacts (such as float switches or relays).(nominal) only.

## Siren and Strobe

The siren and strobe outputs are designed to directly drive audible and visual indicators up to 3W in power. It supplies a nominal 12VDC to the indicator and can supply a maximum combined current of 0.3A to the pair of outputs.

The device will limit the maximum current draw to a peak of approximately 1.5A, but in the event of a sustained overload on either of these outputs (combined current draw exceeds 300mA for 500 milliseconds), the device will detect the problem and shut off both outputs. It will then reattempt to resume normal operation of these outputs every 2 minutes (in case the fault has cleared).

## Fault Output

In addition to the siren and strobe indicator outputs, the unit also provides a universal fault indication output for connection to BMS or other systems. This output is a set of voltage free relay contacts with a capacity of up to 1A and 24VDC.

## Pump Outputs

The pump outputs allow the unit to directly control two, single phase 230VAC pump motors with a full load current (FLA) of up to 16A.

# CONNECTION OVERVIEW

Input	Specification
Input 1	12VDC(nominal)supply into 1.2k $\Omega$ input impedance. Not optically isolated. Sampled at 100Hz.
Input 2	
Input 3	
Input 4	
Input 5	
Strobe output	12VDC Nominal. Combined maximum current draw of 300mA. Electronically protected from overloading.
Siren output	
Fault output	Normally open, voltage free contacts. 1A, 24VDC maximum. Contacts close on fault.
Pump 1 output	240VAC, single phase. Maximum pump size is 1.5kwand/or 16 Full Load Amps. Full electronic overload protect on.
Pump 1 output	

# KEYPAD

The COMPAKT PCB is 100% compatible with all existing Matelec Dual and Single pump APC range keypads. This provides operator control and feedback via seven buttons and ten LEDs:

- Auto/off/manual buttons for each pump
- Mute button
- Power LED
- Level alarm LED (steady for high level, flash for low level)
- Auto/man/active/fault LEDs for each pump

The buttons are arranged in a matrix configuration and are scanned by the controller at a relatively low rate of 100Hz and the matrix input channels include robust electrical filtering. This is designed to minimise the effect of any noise coupled onto the relatively long keypad tail in industrial environments.

# OPERATIONS

The COMPAKT PCB supports most of the operational functionality of the APC6. This includes many advanced features in addition to the basic dual pump operation.

The most common configuration options are selected using a 6-way DIP switch located on the controller.

## DIP Switch Settings

In order for easy operator configuration, 6 DIP switches allow for selecting the most common configuration options as per the following table:

DIP SW	Function	Position	Description
1/2	Operation Mode	Off   Off	A) Standard float switch configuration (start, stop, high level). Optional standby start.
		Off   On	B) Standard float switch configuration with low level (low level, start, stop, high level).
		On   Off	C) Standard float switch configuration (start, stop, high level) with prime loss
		On   On	D) Pressure pumping configuration (Lead, Lag, Low Pressure)
3	Pump Alternate Options	Off	Duty pump alternates each time a pump start is triggered OR after std_alternate_period (30 minutes) of continuous running. Upon high level pumps run until pump stop input opens
		On	Operating pump alternates only after acc_alternate_period (6 hours) of accumulated running. Upon high level both pumps are only run until high level input opens
4	Anti-seize Function	Off	Anti-seize timer disabled
		On	Anti-seize timer enabled
5	Pump Manual Timeout	Off	When placed in manual mode pump remains in manual mode
		On	After manual_timeout (5 minutes) in manual mode the pump will revert to auto mode
6	High Level Alarm Options	Off	High level alarm automatically resets upon lowering of high level float. High level alarm delay = alt_high_level_delay (15 minutes).
		On	High level alarm only resets by holding mute button for 2 seconds (latching). High level alarm delay = high_level_delay (5 minutes).

**Operation Mode A: Standard Configuration**

Stop/Start/High level operation. When the pump start input is triggered the selected pump will be turned on. The pump will remain on until both the pump start and pump stop inputs have turned off. Inputs functions are as per the following table:

Input	Function
Input 1	Standby Start
Input 2	Pump Stop
Input 3	Pump Start
Input 4	High Level
Input 5	External Mute

The standby start function will activate the second pump, only if one pump is already running. Note that this is similar to the high level input except without triggering the high level alarm.

**Operation Mode B: Standard configuration with low level**

Stop/Start/High level operation, plus a low level input. The low level input must be active or pump start and pump stop inputs are ignored. High level input will still override the low level and run both pumps. Input functions are as follows:

Input	Function
Input 1	Standby Start
Input 2	Pump Stop
Input 3	Pump Start
Input 4	High Level
Input 5	External Mute

There is some basic logic to determine, based on the input states, whether a low level or high level condition is to be interpreted:

Low Level	Pump Start	High Level	Pump State	Alarm
On	Off	Off	Off	-
On	On	Off	On	-
On	On	On	Both on	High level (after timeout)
On	Off	On	Both on	High level (after timeout)
Off	Off	Off	Off	-
Off	On	Off	Off	Low level
Off	Off	On	Off	Low level
Off	On	On	Both on	High level (after timeout)

In addition to this logic there is the low level alarm. If there is a low level alarm then both pumps will be locked out until the alarm is manually reset. This lockout will only be overridden upon a high level condition where both the pump start float and high level floats are closed.

**Operation Mode C: Standard configuration with prime loss**

Start/stop/high level operation, with input 1 connected to a prime loss pressure/flow sensor. If at any stage whilst a pump is running the prime loss input turns off for prime\_fault\_delay (2 minutes) then a fault is immediately set for that pump and duty alternates. Input functions are as follows:

Input	Function
Input 1	Prime Switch
Input 2	Pump Stop
Input 3	Pump Start
Input 4	High Level
Input 5	External Mute

**Configuration Mode D: Pressure pumping configuration**

In pressure pumping the system attempts to maintain a constant pressure as best it can using on/off control of two pumps. Input functions are as follows:

Input	Function
Input 1	Prime loss flow switch
Input 2	Lead pump pressure switch (set at 400kPa)
Input 3	Lag pump pressure switch (set at 350kPa)
Input 4	Low pressure switch (set at 200kPa)
Input 5	External Mute

Operation to maintain a minimum pressure is as follows. There is a slight difference in terminology compared with the other operation modes:

Duty Pump:	Lead Pump
Standby Pump:	Lag Pump

Additionally, note that the pressure switches close on low pressure and open on high pressure.

1. If the lead pump pressure switch closes for pressure\_start\_delay, then the lead pump will be switched on. The lead pump alternates each time this occurs.
2. When the lead pump pressure switch opens again the lead pump will turn off. If this occurs before the pump has been running for pressure\_min\_runseconds then the pump will not turn off until this period has elapsed.
3. If the lag start pressure switch closes while the lead pump is running, the lag pump will be activated. The lag pump will remain running until the lead pressure switch opens.
4. If the lag pressure switch activates before the lead pressure switch the lead pressure switch there is no effect and the pumps remain off.
5. If both the low pressure and (lead start and/or lag start) inputs activate then both pumps will be switched on immediately. If this condition exists for pressure\_alarm\_delay then both pumps will be shut down and a low pressure alarm will be signaled. The pumps will remain locked out until the low pressure fault is reset.
6. If both pumps are started due to low pressure and then the pressure is restored both pumps will continue to run until the lead pressure switch deactivates. This is useful in situations where a lag pressure switch is not used.

The prime loss input functions the same as in mode C, with input 1 connected to a prime loss pressure/flow sensor. If at any stage whilst a pump is running the prime loss input turns off for prime\_fault\_delay (2 minutes) then a fault is immediately set for that pump and duty alternates.

In pressure pump mode some of the other operational features will NOT operate:

- Anti-seize timer
- Maximum idle
- Maximum run fault

### Maximum Run and Alternation Mode

With DIP switch 3 set to off the duty pump will alternate under the following conditions:

- Each time a pump start condition occurs, OR
- If a pump has been running continuously for `std_alternate_period` (30 minutes)

Additionally, following a high level both pumps will continue to run until the pump stop input opens.

The duty pump selection is persistent and is retained even after power loss. This can be reset so that pump 1 is the duty pump by holding down the mute button for 2 seconds.

### Anti-seize Timer

When enabled the anti-seize timer will automatically run a pump for `antiseize_run_time` (5 seconds) if a pump has not been run for `antiseize_period` (7 days). This pump operation will completely override all inputs including the low level (if enabled). This feature will only run if the pump is set in Auto, and alternates pump duty so that the alternate pump is operated each time. A pump that has been locked out due to a fault will not run (although low level lockouts are overridden).

The following table shows conditions in which the anti-seize run will not occur:

Condition	Anti-seize will run
Pump mode = off	No
Pump mode = manual	No
Pump overload fault	No
Pump prime fault	No
Pump maximum run fault	No

### Manual Mode Timeout

If this option is enabled then a pump will only remain in manual mode for `manual_timeout` (5 minutes), after which it automatically switches back to automatic mode.

### High Level Alarm Reset

Leaving DIP switch 6 set to off will cause the high level alarm to automatically reset once the high level input turns off. The controller will also use the `alt_high_level_delay` period (15 minutes) for the alarm activation delay.

Setting this switch to on will cause the high level alarm to latch until the unit is reset by holding down the mute button for 2 seconds. The high level alarm will use `high_level_delay` period (5 minutes) for the alarm activation delay.

### Maximum Idle Function

Sometimes it is desirable to keep levels in a tank as low as possible in order to prevent odour buildup, or maximise overhead in the event of an inlet surge. To achieve this the controller features a maximum idle timer, which will trigger a pump start condition if either pump has not run for `max_idle_period` (4 hours), and the stop input is closed. The pump will continue to run until the stop input opens again.

### Staggered Pump Start Delay

There are a number of conditions, especially upon restoration of power, where both pumps may be activated simultaneously. This causes undesired high current draw and associated voltage drop in the power supply cables (and onboard the controller itself). In order to prevent this, mechanisms have been implemented in the software where the startup of pumps is staggered by `staggered_start_delay` (2 seconds).

If no pump is running and both pumps are required to run, the first will be switched on and the second will switch on only after the staggered start delay is up. If the first pump has already been running for more than `staggered_start_delay` when the second pump is called to run then the second pump will activate immediately.

This staggered pump start mechanism operates at the base level of the controller and will override all other features, including manual mode.



### Maximum Run Fault (upon request)

Although the controller features a pump alternate timer (which alternates the pumps after a pump has run for the specified period of time), in some applications this is classed as a fault and the pump needs to be shut down. The maximum run fault function facilitates this.

The maximum run fault operates both in auto and manual modes. If a pump runs continuously for the time specified by the `max_run_fault_delay` parameter then a fault will be flagged. That pump will be disabled until the fault is reset. Setting `max_run_fault_delay` to zero will disable the maximum run fault feature.

Note that for maximum run fault mode to work either DIP switch 3 needs to be set to ON (accumulated alternate period) or `std_alternate_period` needs to be set longer than `max_run_fault_delay`.

### External Mute

Input 5 is configured to be connected to an external mute button. The button will operate the same way as the mute button on the keypad:

- Pressing once will mute the siren
- Pressing and holding for 2 seconds will reset the controller
- Pressing and holding for 3 seconds will perform a keypad LED test

# ALARMS AND FAULT INDICATION

The COMPAKT has a number of fault and alarm conditions that it can detect and report, as per the following table:

Fault	LED State
Pump Overload	Pump Fault LED on steady
Pump Prime Loss	Pump Fault LED flashing slowly
Pump Max Run (If enabled)	Pump Fault LED flashing fast
High Level	Level Alarm LED on steady
Low Level	Level Alarm LED flashing
Low Pressure	Level Alarm LED flashing
Siren/Strobe output fault	Power LED flashing

All faults are latching (with the exception of the high level fault if DIP switch 6 is set to off) and the siren/strobe output fault. In order to reset the fault the mute button needs to be held down for 2 seconds. All faults are persistent, meaning that they are saved and restored following power loss.

When any fault is active the fault outputs on the controller will also be activated. The fault output contacts will close and the siren and strobe will activate.

Pressing the mute button at any time will cause the siren to mute. Alternatively if the unit isn't muted it will continue to sound for 5 minutes and then transition to "chirp" mode. In this mode the siren makes a short "chirp" once every 5 minutes. This minimises the noise pollution generated by the system. Pressing the mute button during chirp mode will silence the system completely.

If a new alarm is triggered the existing mute state will be canceled and the alarm will begin to sound again. The strobe and siren outputs are electronically protected for excessive current draw. If the combined current of both outputs exceeds 300mA for 500 milliseconds then both outputs will be immediately switched off and an alarm fault flagged. In an alarm fault condition the power LED will flash slowly.

After 2 minutes the controller will clear the siren/strobe alarm fault. If the fault condition has been rectified then the system will continue operating normally, otherwise the alarm fault will occur again. This cycle can repeat indefinitely while ever there is a problem with the siren or strobe.

# ELECTRONIC OVERLOAD SPECIFICATIONS

The electronic overload functionality of the system is very precise and provides a reliable method of protecting each pump from overload. Current draw of each pump is sampled with an effective 13-bits at 1.6kHz and the true-RMS calculated in real time within the controller (using a 32-sample rolling buffer).

## Trip Curves

Every 20 milliseconds the controller performs an overload calculation. This simulates the operation of a standard bimetallic thermal overload and  $I^2 R$  heating effects. It will allow a startup current of up to 10 times the full load current of the pump for 1 second before tripping. The trip curves can be viewed below.

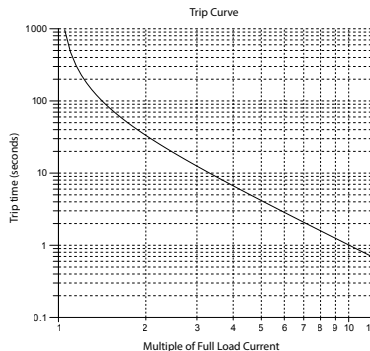

Note that at its maximum overload setting of 16A, the current sensing circuits can measure a maximum of 12x the full load current and thus the minimum trip time is limited to approximately 2.5 seconds as shown in the above plot. In the case of a lower overload setting (for example, 10A) the system can react proportionally to even higher multiples of the full load current. A multiple of 50x FLA will cause the overload to occur within 30ms; the shortest reaction time possible.

Key times to trip are:

Multiple of Overload Setting	Trip Time
1x	Will not trip
1.05x	16 Minutes 16 Seconds
1.5x	1 Minute 20 Seconds
5x	3.84 Seconds
10x	1 Second

## Cooldown

By nature of their construction, bimetallic strip based overloads have an automatic cool-down time after a trip event before the overload can be reset. The electronic overload simulates a similar function.

When an overload condition results in the unit switching off the pump the unit will simulate the cool-down. It will take approximately 100 seconds for the cool-down to complete and therefore it will not be possible to reset the overload fault for that pump during that period.

Cycling power to the controller will immediately reset the cool-down timers and allow the pumps to be run again immediately, however this is not a recommended technique. Most of the time there will have been a sufficient period of time elapsed between the alarm triggering and a technician arriving on site that the cool-down timer will have elapsed any way.

# CIRCUIT DIAGRAM

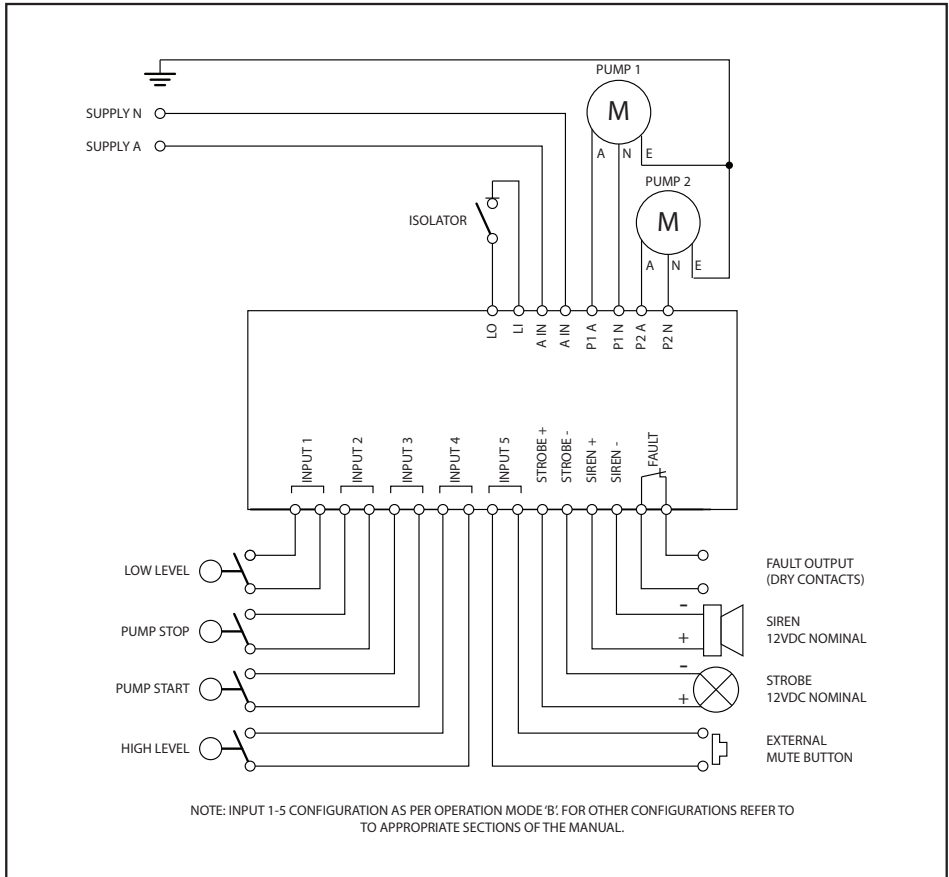



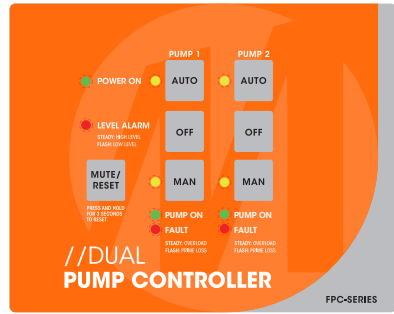

# AT A GLANCE

A quick reference to the controller's Keypad and Indicator functions and meanings.







KEYPAD

## INDICATORS

- 
**POWER ON**  
**POWER ON**  
 Power is turned on.
  
- 
**LEVEL ALARM**  
**LEVEL ALARM ON**  
 A high level alarm has been present for the preset time.  
**FLASHING**  
 A low level alarm is present.
  
- 
**PUMP ON**  
**ON STEADY**  
 Pump switched on to run.
  
- 
**FAULT**  
**ON STEADY**  
 A pump fault/overload has occurred.  
**FLASHING** A prime loss fault has occurred.

## PUSH BUTTONS

- 
**MUTE/RESET**  
 Silences the siren and if held down for 3 seconds, clears all faults
  
- 
**AUTO**  
 If selected (the LED indicator will confirm if on) the particular pump is set to Automatic Pumping Mode
  
- 
**OFF**  
 Turns pump off
  
- 
**MAN**  
 If selected (the LED indicator will confirm if on) the pump is set to Manual Pumping Mode

DISTRIBUTED BY:

INSTALLATION DATE:

SERIAL NUMBER:

MANUFACTURED BY MATElec AUSTRALIA

MATElec reserves the right to alter technical specifications without notice.

EMAIL: [info@matelecaustralia.com.au](mailto:info@matelecaustralia.com.au)