

## SOLAR PANEL KIT

### 5 SOLAR PANEL POST MOUNT KIT

#### Kit Includes:

- MC4 lead 3m x 2
- MC4 lead 10m x 2
- 1000V 25A DC Plug-n-Play Isolator
- Post Mount Framing
- 370W Solar Panels

MODEL	BIA-5-PM SOLAR PANEL KIT
Product Type	Solar Array
No of Posts	1
Panels	5 x 370W
Total Watts	1850W

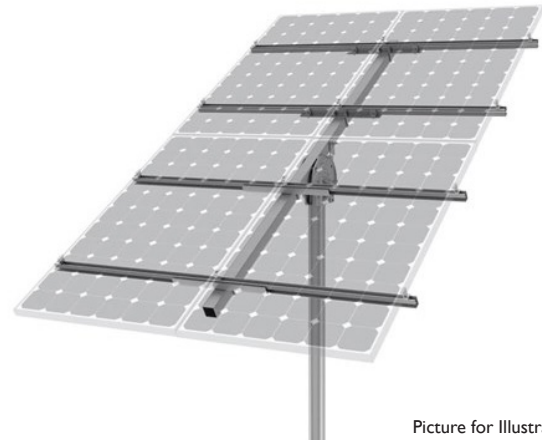

Picture for Illustration use only

#### WARRANTY:

- Solar Panels: 12 Year product warranty  
25 year linear performance warranty
- Frames: 10 year warranty

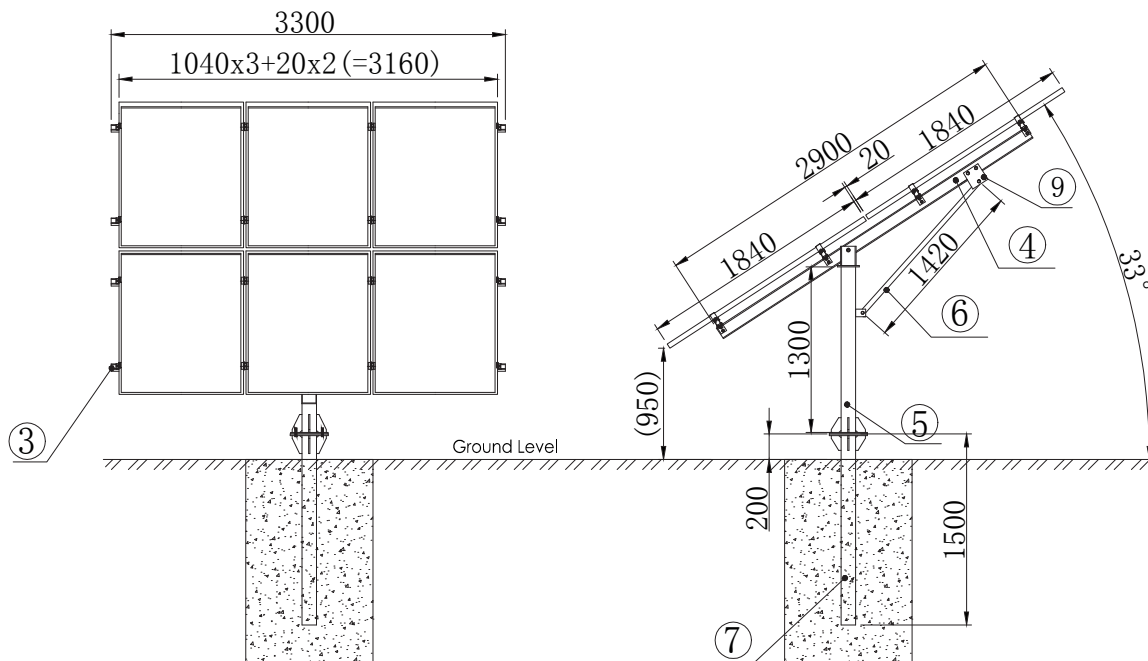

Part No	Item	Size (mm)	Qty
1	Middle Clamp	35	8
2	End Clamp	35	8
3	U Channel	41x62x2 L3300	4
4	Cross Beam	80x40x3 L2900	1
5	Support Post	D140x6 L1300	1
6	Adjustable Arm	40x40x2.5 L1420	1
7	Ground Leg	D140x6 L1500	1
8	Rail Clamp		8
9	Connecting Plate		2

