



AROMA DIFFUSER

MODEL: LF500M

USER MANUAL

Please read the manual carefully before
use and keep it for future reference.



SAFETY PRECAUTIONS

- When the room temperature is below 32°F / 0°C, please empty the water tank. If the water is allowed to turn to ice it can damage the components.
- Please use purified or distilled water so that your atomizer will not be damaged due to impurities in the water. If you use normal tap water you may notice a white buildup of calcium or lime in the diffuser.
- The maximum water volume is 16.9 oz/500 ml. Exceeding the max capacity line will affect the atomization effect or cause water leakage and damage to the machine.
- Do not let water splash into the base to avoid damaging the internal parts.
- After use you must pour out the remaining water in the water tank to prevent damage to the atomizer. Do not leave water sitting in the tank for several days without use.
- When cleaning or adding water to the device, always remove the AC adaptor from the outlet. Do not insert or remove the AC adaptor with wet hands. Doing so may cause electric shock or injury.
- Do not replace the power cord without authorization.
- In case of abnormality, do not attempt to disassemble or repair the device by yourself. Doing so could cause fire, electric shock, injury, or malfunction. Please stop operation and send an email to support for help.



WARNING Cancer and Reproductive Harm
www.p65warnings.ca.gov

PARTS

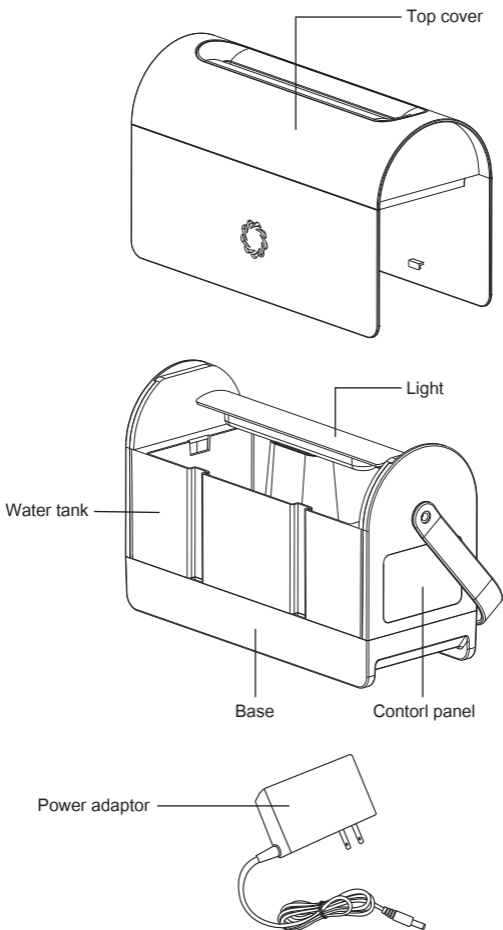

Note: The accessories in the package are exclusively used for the product. The appearance and quantity may be different for different batches. Please contact support if you have any questions.

SPECIFICATIONS

Model	LF500M
Rated Voltage	DC 24V \approx 1.5A
Rated power	12W
Water Tank Capacity	500 ml / 16.9 oz
Mist Output	35 - 65 ml/hr
Timer Setting	1 - 8 hours
Weight	2.0 lbs
Dimensions	9.4 x 3.9 x 6.3 in

OPERATION

1. Remove the top cover.
2. Add water to the max fill line.
Add 2-5 drops of scented essential oil directly to the tank if you wish.

Note:

- The maximum water volume is 16.9 oz/500 ml. Exceeding the max capacity line will affect the atomization effect or cause water leakage and damage to the machine.
- Please use purified or distilled water so that your atomizer will not be damaged due to impurities in the water. If you use normal tap water you may notice a white buildup of calcium or lime in the diffuser. While not harmful, these deposits may cause a white powder to form when the mist dries or inside the machine. These deposits can be cleaned with distilled white vinegar.

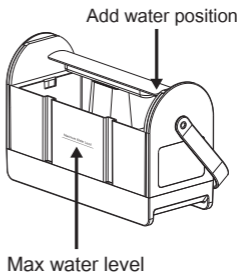
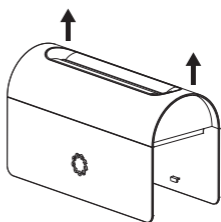

3. Place the top cover back onto the diffuser.

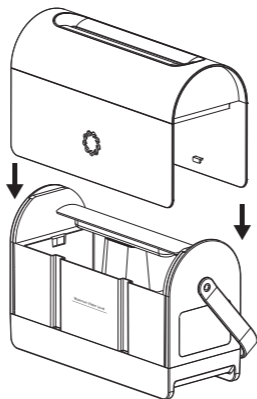

4. Insert the power adapter cord.

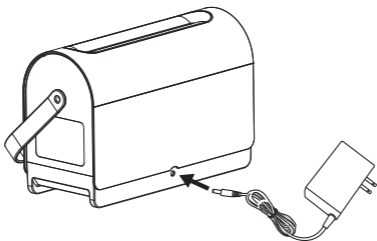

5. Press the power button and you will hear a beep sound.

The default settings are as follows:







Atomization level: 2 (high)

Brightness: medium

Lighting effect: full bright

CONTROL



Function selection	
 Switch	Power on / Power off
 Timer	1-8 hours
 Light brightness	1: Low 2: Medium 3: High
 Lighting effect	<ul style="list-style-type: none">• Full light• Breathing light• Flashing light
 Mist level	1: Low (soft flame effect) 2: High (violent flame effect) Lights out (sleep mode)
 Low water icon	Unit automatically powers off

Notes:

- After powering on, there will be a beep sound
- There will be a beep each time you press a button.
- When there is no water in the tank you will hear 2 beeps over 5 seconds and the diffuser will automatically power down. The low water icon will also illuminate
- When the timer is up you will hear a long beep sound before the diffuser automatically shuts down.

CLEANING INSTRUCTIONS

1. Drain the water remaining in the water tank. Ensure the air outlet side is facing up during draining to avoid moisture getting inside the unit.
2. Do not use any benzene, paint thinner, alcohol, or other types of chemicals during cleaning. Doing so may cause damage to the machinery.
3. If using detergent, always use mild kitchen detergent. Chlorine, acid, and enzyme-type detergents remaining inside pose the danger of emitting noxious gasses. Distilled white vinegar is recommended for cleaning.
4. If you do not intend to use the product for an extended period of time, clean it and dry it thoroughly before storage. .

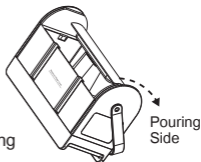

TROUBLESHOOTING

Symptom	Possible Causes	Approach
The power-on indicator does not light up and the diffuser cannot be started	No power	Reconnect the power adapter and try again
The indicator light is on, but there is no mist produced	The water tank is short of water or has too little water, the low water icon will illuminate	Add purified water to the tank
	Too much water	Pour water lower than the max capacity line. Exceeding the max capacity line will affect the atomization effect
The humidifier emits a weird smell	There is scale in the water tank, the added water has impurities, or the water has been left in the tank for too long	Remove the lid of the water tank and place it in a cool place for more than 12 hours to ventilate. Clean the water tank with white vinegar and refill with pure water

Symptom	Possible Causes	Approach
Too little mist produced	There is dirt on the atomizing film or the water in the water tank has been left for too long	Clean the water tank and add pure water
	Too much water	Pour water lower than the max capacity line. Exceeding the max capacity line will affect the atomization effect
The diffuser is too noisy	Too little water	Add water to the tank
If the above methods cannot be improved, please consult the customer service hotline for assistance		

LIMITED WARRANTY

We provide a **1-year** warranty. For more information please visit www.airthereal.com/warranty.

• What's covered?

Defects due to faulty materials and/or workmanship of the product.

• What's not covered?

1. Damage caused by the owner when attempting to fix or altering the product by himself or herself.
2. Damage caused by misuse, abuse, neglect, alterations or unauthorized repair.
3. Natural depreciation.

• Warranty Period

Warranty becomes effective from the date of original purchase and will last for **1 year**.

• Who's covered?

This limited warranty is only effective for the original purchaser, it is non-transferable.

• How to request warranty services?

To obtain the benefit of this warranty, please email support@airthereal.com. Our customer service will address your issue as soon as possible!

Always here to help you

www.airthereal.com

support@airthereal.com

Produced for: West Ryder Technology LLC

2330 Paseo Del Prado STE C304 Las Vegas, NV 89102 USA

