

# USER MANUAL

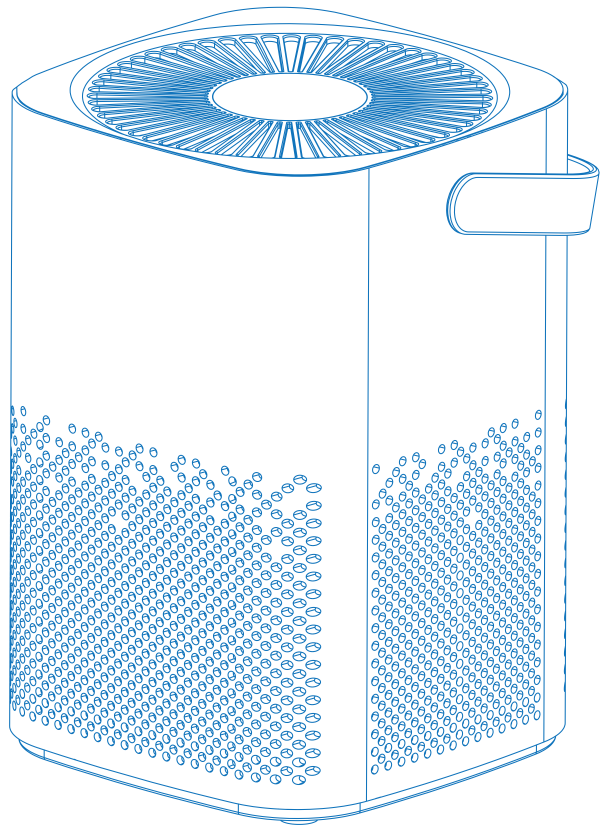

AIRTHEREAL

## Day Dawning ADH70 HEPA AIR PURIFIER



# CONTENTS

- COMPONENTS ..... 2
- SPECIFICATIONS ..... 3
- IMPORTANT SAFETY INSTRUCTIONS ..... 4
- INSTALLATION INSTRUCTIONS ..... 5
- OPERATION ..... 6
- MAINTENANCE ..... 8
- CLEANING ..... 9
- TROUBLESHOOTING ..... 9
- LIMITED WARRANTY ..... 10

# COMPONENTS

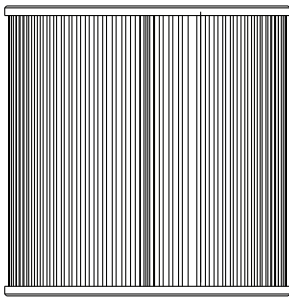
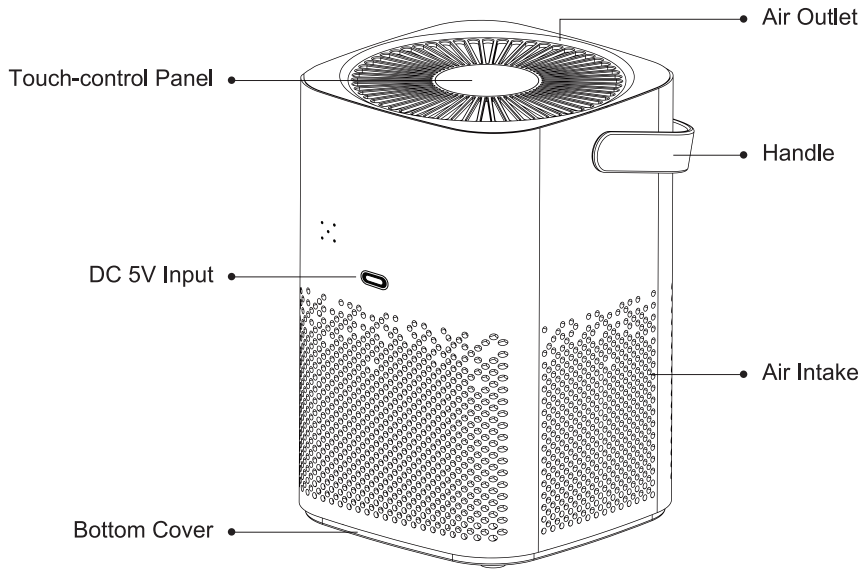

HEPA Filter

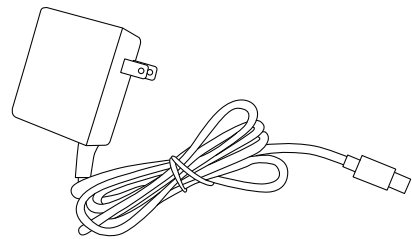

Adapter

# SPECIFICATIONS

Model Number	ADH70
Power Supply	DC 5V
Rated Power	6W
CADR	41 CFM (70m <sup>3</sup> /h)
HEPA Filter Lifetime	6 months
Noise Level	≤ 55dB
Operating TEMP	32°F-111°F (0°C-44°C)
Dimensions	5.9 x 5.9 x 8.8 Inch (150 x 150 x 223 mm)
Weight	1.8 Lbs (0.82 kg)



Intertek  
5019070

COMFORMS TO UL STD.867  
CERTIFIED TO CSA STD.C22.2 NO.187

**Meets California  
ozone emissions limit.  
CARB certified.**

# IMPORTANT SAFETY INSTRUCTIONS

## IMPORTANT:

Please read and comply with all of the instructions and warnings in the manual before using. Failure to comply with the instructions and warnings provided herein may result in inaccurate results and/or damage to the product itself.

## General Safety

**Only use this air purifier as described in this manual.**

- Ensure the DC adapter of the purifier fits properly into an AC power outlet.
- When not being used, turn the air purifier off and disconnect it from its power source by unplugging it from the electrical outlet.
- DO NOT operate the unit if its cord or plug is damaged. It may result in damage to the unit or injury. If damaged, the power cord must be replaced by the manufacturer or other qualified person.
- NOT recommend using an extension cord with this product.
- Thoroughly dry your hands before operation.
- DO NOT immerse the air purifier in water or liquids. It may result in damage to the appliance, electric shock, or fire.
- DO NOT use the air purifier outdoors. This appliance is designed for indoor use only.
- DO NOT use the air purifier in an enclosed space where flammable, combustible, or explosive gasses are present.
- DO NOT use in an area where toxic vapors, flammable dust, or oxygen tanks are present.
- DO NOT insert fingers or objects into the air outlet.
- Child supervision is required while the air purifier is on. Do not allow children to play with, on, or near the air purifier.and/or damage to the product itself.

## Use & Care

- Always make sure to place the air purifier on a flat, level surface before operation.
- Always allow 15 inches (38 cm) of clearance on all sides of the purifier.
- DO NOT ROUTE CORD UNDER FURNITURE OR APPLIANCES. Do not run the power cord under carpeting. Do not cover cord with throw rugs, runners or similar coverings. Place the power cord away from high traffic areas.
- DO NOT sit on or place anything on top of the purifier.
- DO NOT place the air purifier near sources of heat, such as stoves, ovens, radiators, or computers.
- DO NOT use this appliance with indoor smoke-type insect repellents or in places with oily residues, burning incense or chemical fumes.
- DO NOT open the bottom cover while the air purifier is on. It will automatically turn off the unit.
- Always unplug the appliance from the power supply before servicing.
- DO NOT clean the appliance with water or any other liquid to avoid electric shock or injury.
- DO NOT attempt to repair this device in any way or use any replacement components or parts to modify the air purifier. Contact Customer Support immediately if your appliance is no longer working.
- Only use Airthereal Day Dawning ADH70 replacement filters for this unit.
- If you experience any problems while operating the air purifier, refer to the Troubleshooting section in the manual. If the problem is NOT solved, contact Customer Support.
- If the unit is damaged or NOT functioning properly, discontinue use and contact Customer Support.

# INSTALLATION INSTRUCTIONS

1. Rotate the bottom cover counterclockwise and remove the HEPA filter (which is sealed in plastic when it arrives).

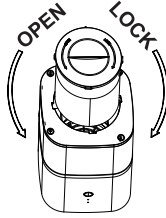

2. Remove the plastic seal from the filter.

**NOTE:** The plastic seal must be removed, otherwise the machine will not work).

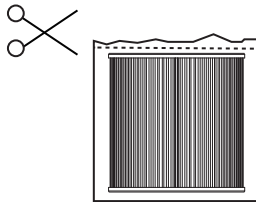

3. Place the filter back into the unit. Close the bottom cover by rotating it clockwise.

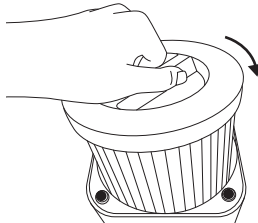

4. Place the air purifier where desired with at least 15 inches of open space around all sides of the purifier.

**NOTE:** Place at least 15 inches away from TVs, radios, and other electronic products. Electromagnetic interference from certain electronics may cause product malfunction. Only use the unit on firm and flat surfaces. Flimsy or slanted surfaces may result in abnormal noise and vibrations.

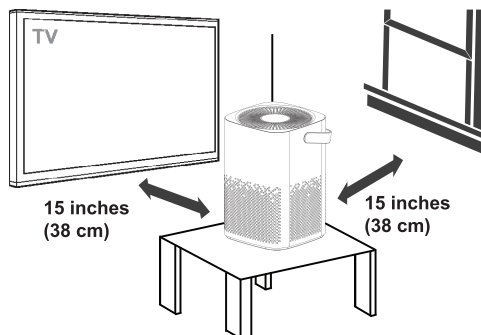

# OPERATION

Follow these instructions to reduce the risk of serious injury or death and to reduce risk of damaging the unit.

1. Plug the cable into the power input on the back of the air purifier. (Only use the adapter that comes with the device, otherwise the air purifier may not working properly. )

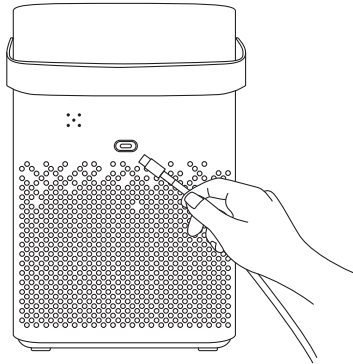

2. Plug the adapter into a 120V power outlet. The purifier will beep when plugged into a proper power source.

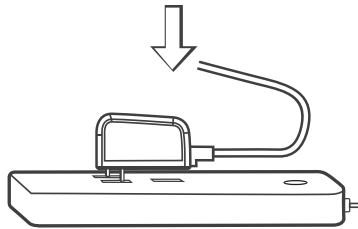

3. Turn on the air purifier - the air purifier power indicator will light up blue and work at medium (2) speed.

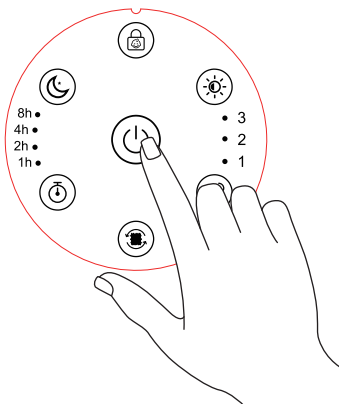

4. Select the appropriate working mode for your room.

## Touch-control panel introduction



### Power Button

- Press the "power" button, and the air purifier will run at medium speed, the power indicator and speed indicator will be light up.
- Press the "power" button again to turn off the air purifier.



### Child-Lock

Press and hold the Child-Lock button for 3 seconds to Lock and unlock.



### Light Button

Press the button to turn off the light. (The light turn on by default when power on.)



### Fan Speed

Press to start air circulation. 3 fan speeds are available (low, medium, and high, corresponding with the values 1, 2, and 3 on the LED Display).



### Replace the Filter

When the icon turn red, it mean the filter need to replace. After replace the filter, you should press and hold the button for 5 seconds until the red light turn off, Then you can use as normal.



### Timer

Press to button to timer mode, you can set time to turn on/off the unit. (Timer can be set from 1-2-4-8 hours or to NO TIMER, corresponding to values 1-2-4-8h on the LED display.)



### Sleep Mode

Press to turn on the Sleep Mode.

#### NOTE:

- Press any button to turn off the unit.
- Sleep Mode uses the lowest fan speed.
- The light of the bottom will keep the setting before sleep mode, if you want to turn off, press the light button to turn off.



# MAINTENANCE

**We recommend replacing the air filter every 6-8 months for optimal use.**

► It's time to replace the air filter when the below signals appear:

- Increased noise
- Decreased airflow
- Clogged filters
- Presence of odors from the unit

► Purchase a new Airthereal Air Filter Replacement:

• Visit: [www.airthereal.com](http://www.airthereal.com)

• Search B0BZVK3VFK on Amazon for ADH70 air purifier replacement filter  
(Only use Airthereal Day Dawning ADH70 replacement filters for this unit.)

► Replace the Air Filter

1. Power off and unplug the unit, then rotate the bottom cover.

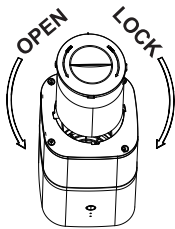

2. Remove the old filter. Unwrap a new one and install it in the unit.

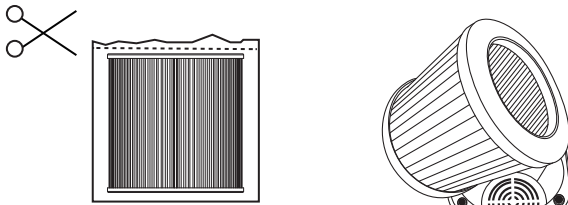

3. Power the unit on. Press and hold the filter button for 5 seconds until the red light turns off to reset the replacement reminder.

**NOTE:** If the bottom cover is not installed properly the unit will not power on.

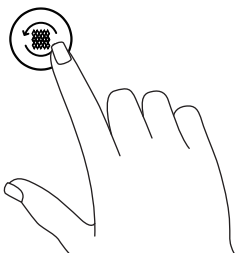

# CLEANING

► **Unplug the power cord before cleaning.**

- The plastic shell should be cleaned with a soft, damp cloth.
- Add mild detergent as needed.
- Remove the front panel and clean the air outlet with a vacuum cleaner to remove any dust.
- For optimal maintenance, clean the unit every 2 months.

# TROUBLESHOOTING

Problem	Cause	Solution
No power or response.	Unit is not plugged into an electrical outlet.	Connect the plug to a powered electrical outlet.
	Outlet is not working properly.	Try plugging the air purifier into a different outlet.
	Bottom cover is not properly placed on the unit.	Properly replace the button cover as noted in the Getting Started section.
	Power cord is damaged.	Immediately discontinue use and contact Customer Support.
	Air purifier is defective or malfunctioning.	
Unusual noise while operating.	Dirty filters.	Replace the air filters as instructed.
	Filters installed improperly.	
	Foreign object inside the unit.	Immediately discontinue use and contact Customer Support. DO NOT attempt to open the air purifier.
	Flimsy or slanted surfaces resulting in abnormal noise and vibrations.	Place air purifier on hard, flat surfaces.
Significantly reduced airflow.	Not enough space around the unit.	Ensure that there is at least 15 inches (38 cm) between the unit and other objects.
Poor air purification quality.	Surrounding area exceeds the applicable area.	ADH70 is applicable to a small house.
	Air inlet or outlet is blocked.	Remove objects that block the air inlet or outlet.
	Filter(s) not properly placed in housing.	Properly place the filter as noted in the Getting Started and Replacing the Filters sections.

# LIMITED WARRANTY

We provide a 2-year warranty from the day of purchase. For more information please visit [www.airthereal.com/warranty](http://www.airthereal.com/warranty).

## What's covered?

Defects due to faulty materials and workmanship of the product.

## What's NOT covered?

1. Damage caused by the owner when attempting to fix or altering the product by him or herself.
2. Damage caused by misuse, abuse, neglect, alterations, or unauthorized repair.
3. Natural depreciation.

## Warranty Period

Warranty becomes effective from the date of original purchase and will last for 2 years.

## Who's covered?

This limited warranty is only effective for the original purchaser. It is non-transferable.

## How to request warranty services?

To obtain the benefit of this warranty, please email [support@airthereal.com](mailto:support@airthereal.com). Our customer service team will address your issue as soon as possible!



**WARNING Cancer and Reproductive Harm**  
[www.p65warnings.ca.gov](http://www.p65warnings.ca.gov)

Always here to help you  
[www.airthereal.com](http://www.airthereal.com)



**Keep Out Of Reach Of Children**

Produced for: West Ryder Technology LLC  
2330 Paseo Del Prado STE C304 Las Vegas, NV 89102  
EPA EST NO: 99066-CHN-1  
[support@airthereal.com](mailto:support@airthereal.com)

Made in China

V 20240218

FOR THE AIR WE CARE