

EXIDOR

700 SERIES

HEAVY DUTY HIGH SECURITY
LOCKS, BOLTS & EXIT HARDWARE



CE 1121
AAA024
EN 1125: 2008
37601321AA

What's inside

04	Security testing	21	High security automatic deadlocking range	28	Parts list
05	Product selector	22	Outside access devices	29	Regulations
07	Single door range	24	Accessories	30	Glossary
15	CE marked double door range	26	Keep options	31	Product features
18	Non CE marked double door range	27	Technical data		

Guarantee

To support the high quality and first class engineering that has gone into the Exidor range, the manufacturer gives a ten year guarantee (subject to conditions) against defects due to faulty manufacturing, workmanship or defective material. The manufacturer agrees to replace any defective Exidor product free of charge provided the product has been fitted in accordance with the fitting instructions and maintained correctly.

Technical Support

Comprehensive information and technical support services are available by contacting:

Tel: +44 (0)1543 460040 Fax: +44 (0)1543 570050
email: technical@exidor.co.uk

Or visit our website:

exidor.co.uk

There are a number of enhancements we've made to the Exidor website. You'll also find new company info, technical data, and downloadable pdfs of the latest product literature – all presented in a clear and contemporary style that we hope you'll enjoy.

We're aiming to keep on improving the website, with more new specifiers on the way, and additions to our gallery of products and projects. If you have comments and ideas on ways we can make it even better and more useful, just let us know.

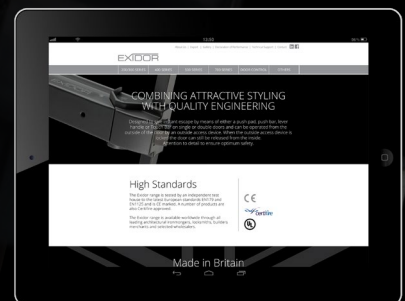



Introducing the 700 Series High Security Bolts & Exit Hardware

Exidor Ltd is a UK based engineering company manufacturing a comprehensive, high specification range of innovative panic and emergency exit hardware, and security products.

We've been meeting the needs of architects, specifiers, project managers, OEM's and building managers for more than 60 years. In that time, we've built an unrivalled record of developing and continually enhancing a product range that's known all over the world.

The Exidor 700 series heavy duty high security system combines the requirements of safety and security with the functions of a panic and emergency exit device. The range has been specifically developed to meet the demands required against a physical attack without compromising safety.

The 700 series is British manufactured from high quality steel for strength and rigidity and available in both steel and timber door versions.

All products in the range are manufactured to the highest specifications and, where applicable, have been certified to the European Standards EN1125 for Panic Exit and EN179 for Emergency Exit Devices.

The Exidor 700 series has also been approved to LPS1175 level 6 (Burglary resistance test), Sold Secure Silver Standard and is suitable for high security applications.

Certified to 200,000 uses, the 700 series is available in single, two, three or four point locking, depending on the level of security required, as well as a multi-bolt version for use where emergency exit is not required. Accessories include a choice of outside access devices, locking boxes, high security cylinder escutcheons and heavy duty tower bolts.

All products are available in RAL 7016 finish, stainless steel effect or, where the operating environment is highly corrosive, a solid stainless steel version is available, on request.



What does British manufacturing mean to us?

Understanding what our customers need. Providing local and reliable service. Having a wide range of standard units available from stock for next day delivery. Being able to provide non-standard products. Reacting quickly when it matters. Working to International quality and manufacturing standards and certified to ISO 9001. And caring – professionally – about quality.

High Security Bolts & Exit Hardware

Tested and Approved to LPS1175 Level 6 Burglary Resistance Test and Sold Secure Silver Standard



Attacking the door with a chisel and mallet to remove the skin.



With the door skin removed, a drill is used to attack the hardware.



Inside view after 10 mins and the 4th bolt is still holding the door secure.



Inside view after 15 mins and the 4th bolt is still holding the door secure.



Inside view after 20 mins and the mechanism has jammed preventing entry.

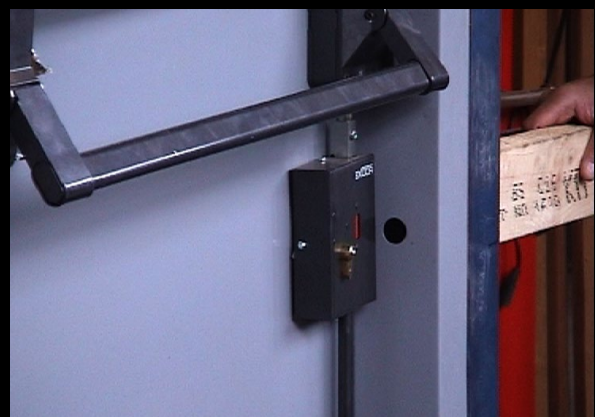

Inside view shows the door is held closed.

Product Selector

Single Doors

Lever Handle Operated

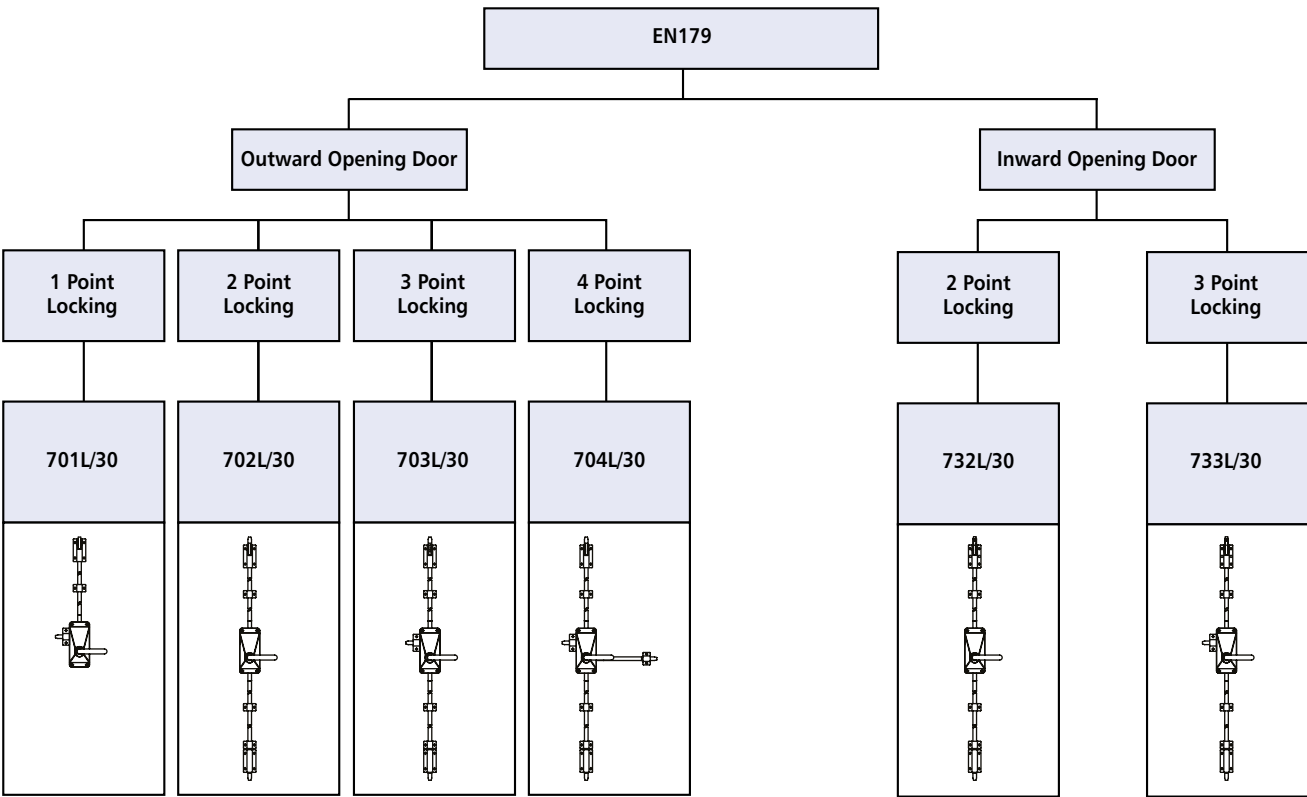

Push Bar Operated

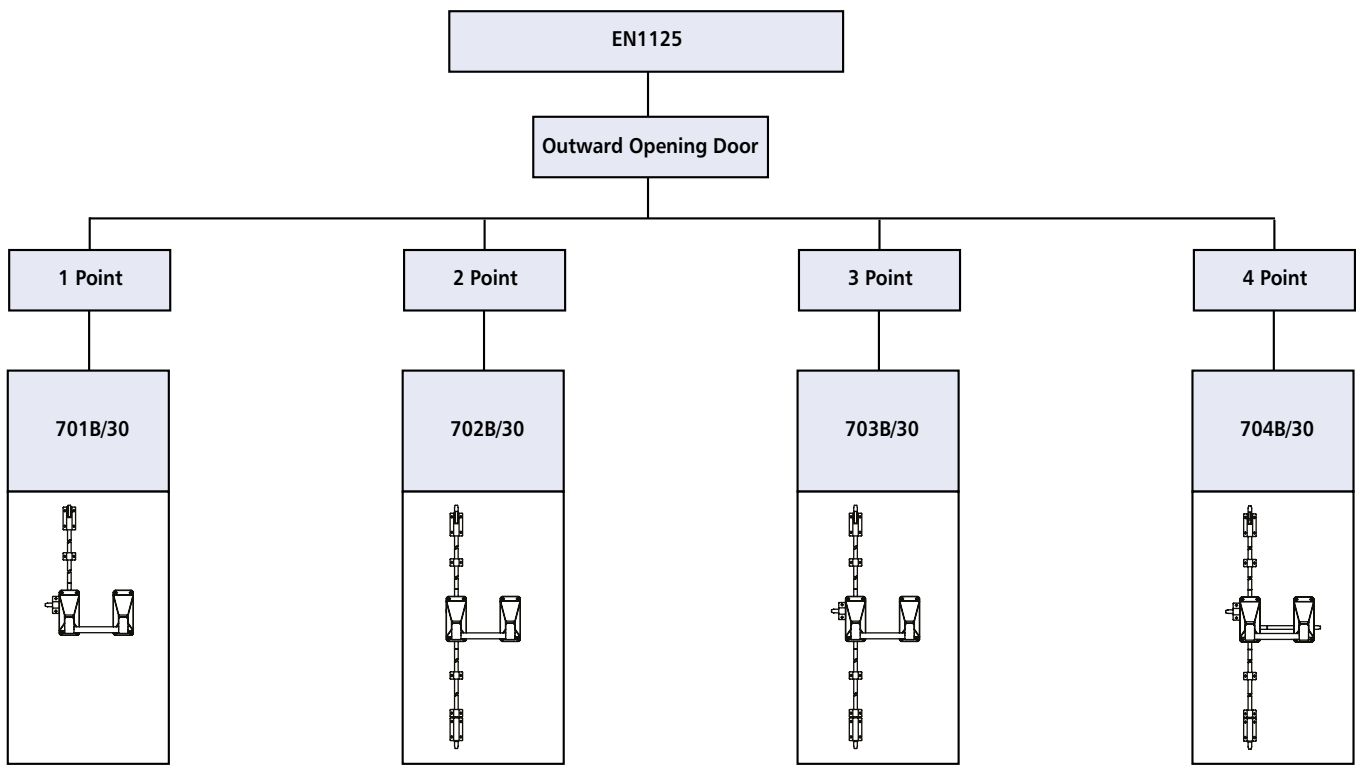

Product Selector

Double Doors

Push Bar Operated

Push Bar Operated with Overlap

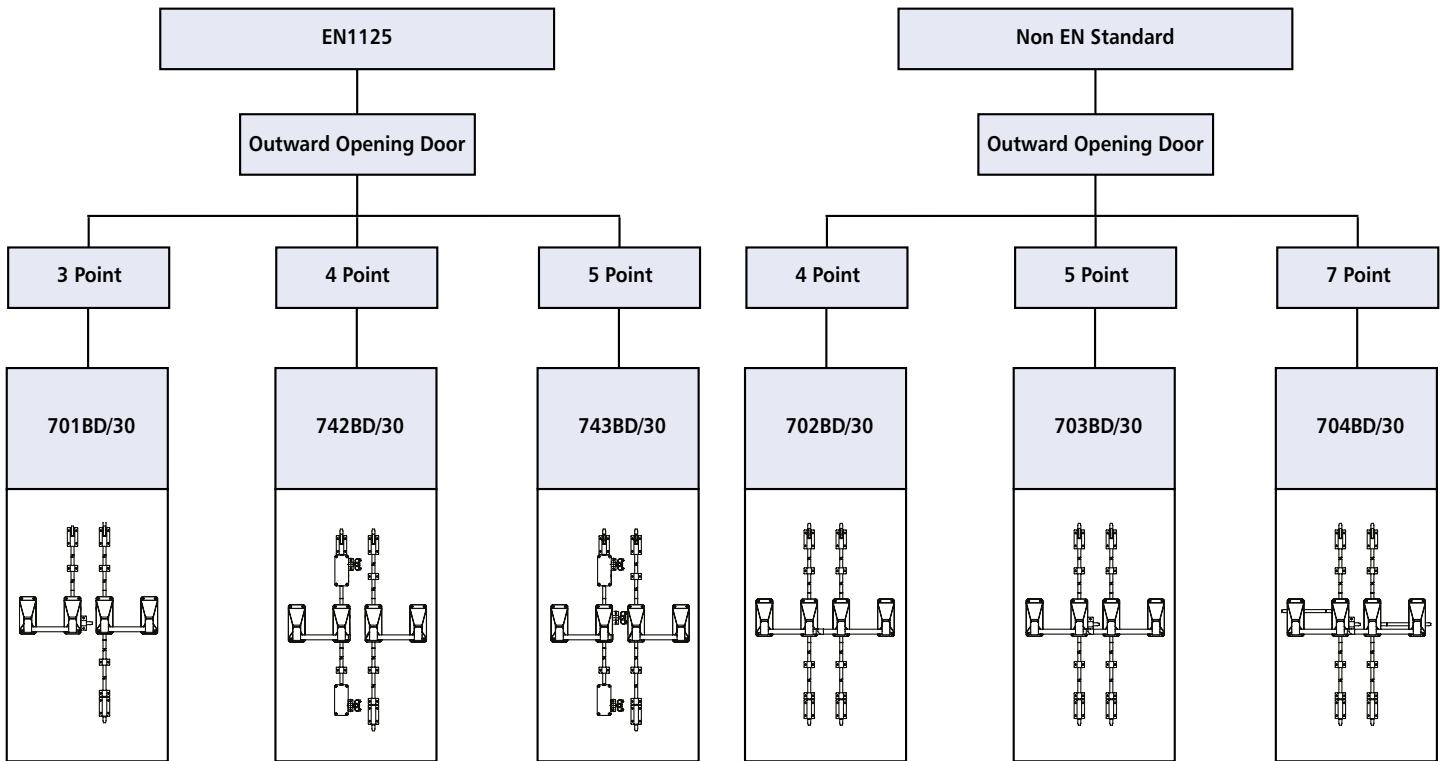

High Security Multi-Bolt

Single Doors

Lever Handle Operated

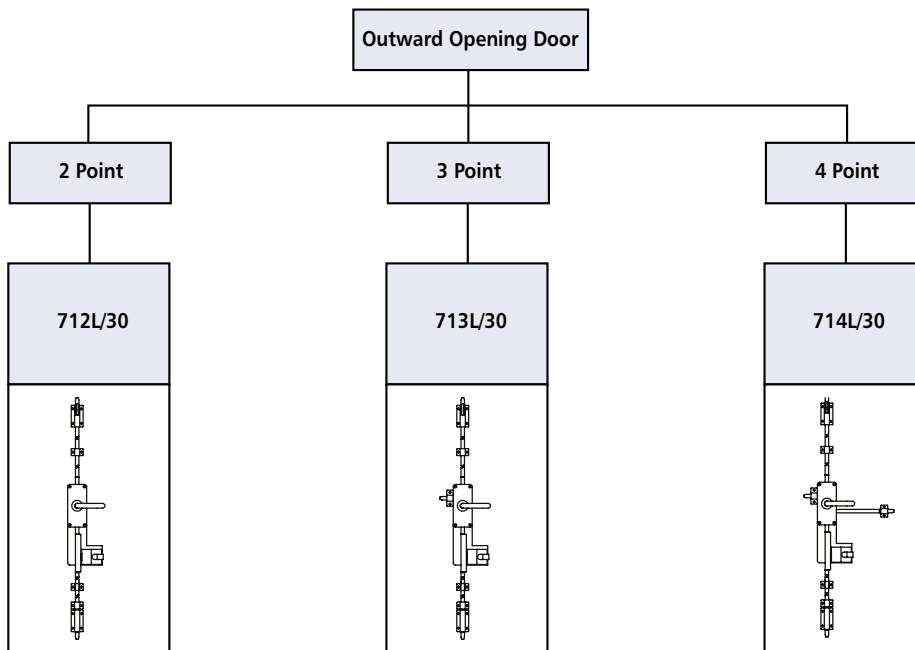

Single Door 701L/30

BS EN 179



SINGLE POINT LOCKING
OUTWARD OPENING DOORS

701L/30

Classification No.	3	7	6	B	1	3	5	1	A	A
EN 179 : 2008										

The Exidor 701L/30 is a high security surface mounted emergency exit latch for outward opening single door applications. Simply depressing the lever provides safe and speedy exit in the event of an emergency. The main body is constructed from a mixture of steel and stainless steel, with steel being used for the internal components and bolts. There is also an anti-thrust latch mechanism in the main unit making it suitable for use in high security applications.

- Handed, please refer to handing diagrams on page 27
- Surface mounted
- 30mm bolt throw
- Anti-thrust latch bolt mechanism in the main body to prevent physical attack
- Steel and timber door versions available

Steel door - 701L/30S/LH (left handed), 701L/30S/RH (right handed)

Timber door - 701L/30T/LH (left handed), 701L/30T/RH (right handed)



701L/30/RH

Optional accessories for the 701L/30

- 709EC Outside access device with Euro cylinder – knob operated
- 709EC/NC Outside access device with Euro aperture – knob operated
- 710EC Outside access device with Euro cylinder – lever operated
- 710EC/NC Outside access device with Euro aperture – lever operated

Finishes

Available in RAL 7016, Stainless Steel Effect, Solid Stainless Steel. Other finishes available on request.

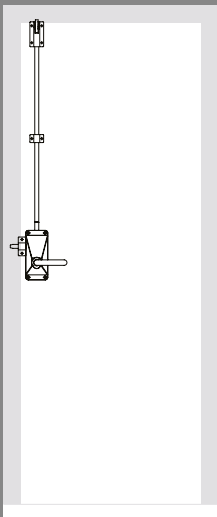

701L/30/LH

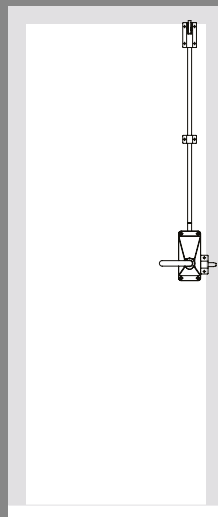

701L/30/RH

The top shoot mechanism allows for automatic re-latching, but the shoot does not enter the frame.

Single Door 702L/30 | 732L/30

BS EN 179



TWO POINT LOCKING
OUTWARD OPENING DOORS

702L/30

Classification No.	3	7	6	B	1	3	5	1	A	A
EN 179 : 2008										

The Exidor 702L/30 is a high security surface mounted two point emergency exit bolt for outward opening single door applications. Incorporated as standard is an automatic top trip mechanism. The main body is constructed from a mixture of steel and stainless steel, with steel being used for the internal components and bolts. There is also an anti-thrust mechanism in the bottom bolt, making it suitable for use in high security applications.

- Non-handed
- Surface mounted
- Adjustable top and bottom bolts
- 30mm bolt throw
- Anti-thrust bottom bolt to prevent physical attack
- Steel and timber door versions available

Steel door - 702L/30S
Timber door - 702L/30T

INWARD OPENING DOORS

732L/30

Classification No.	3	7	6	B	1	3	5	1	A	D
EN 179 : 2008										

The Exidor 732L/30 offers all the security functions and convenience of the Exidor emergency exit bolt, but is suitable for use on inward opening single door applications. Simply depressing the lever provides safe and speedy exit in the event of an emergency.

- Non-handed
- Surface mounted
- Adjustable top and bottom bolts
- 30mm bolt throw
- Anti-thrust bottom bolt to prevent physical attack
- Steel and timber door versions available

Steel door - 732L/30S
Timber door - 732L/30T



702L/30 | 732L/30

Optional accessories for the 702L/30 and 732L/30

- 709EC Outside access device with Euro cylinder – knob operated
- 709EC/NC Outside access device with Euro aperture – knob operated
- 710EC Outside access device with Euro cylinder – lever operated
- 710EC/NC Outside access device with Euro aperture – lever operated
- 705EC/LH Mechanical locking box with Euro half cylinder – left handed
- 705EC/RH Mechanical locking box with Euro half cylinder – right handed
- 705EA/LH Mechanical locking box with Euro aperture – left handed
- 705EA/RH Mechanical locking box with Euro aperture – right handed
- 705TC/LH Mechanical locking box with 80mm Euro profile double cylinder – left handed
- 705TC/RH Mechanical locking box with 80mm Euro profile double cylinder – right handed

- 705TA/LH Mechanical locking box with 80mm Euro aperture – left handed
- 705TA/RH Mechanical locking box with 80mm Euro aperture – right handed

Finishes

Available in RAL 7016, Stainless Steel Effect, Solid Stainless Steel. Other finishes available on request.

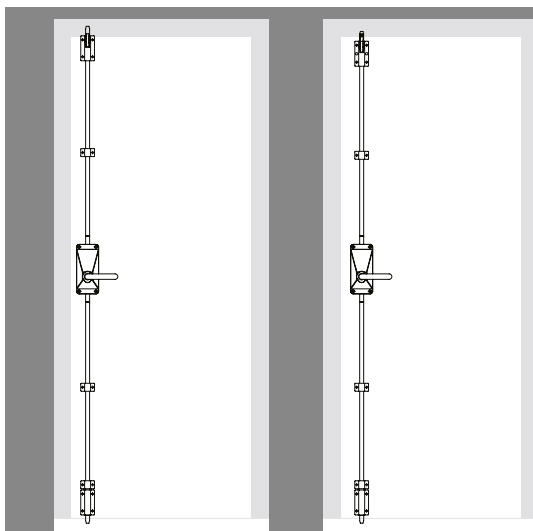

702L/30

732L/30

Single Door 703L/30 | 733L/30

BS EN 179



THREE POINT LOCKING
OUTWARD OPENING DOORS

703L/30

Classification No.	3	7	6	B	1	3	5	1	A	A
EN 179 : 2008										

The Exidor 703L/30 is a high security surface mounted three point locking emergency exit bolt for outward opening single door applications. Incorporated as standard is an automatic top trip mechanism. Simply depressing the lever provides safe and speedy exit in the event of an emergency. The main body is constructed from a mixture of steel and stainless steel, with steel being used for the internal components and bolts. There is also an anti-thrust mechanism in the bottom bolt, and the latch bolt, making it suitable for use in high security applications.

- Non-handed
- Surface mounted
- Adjustable top and bottom bolts
- 30mm bolt throw
- Anti-thrust bottom bolt and latch bolt to prevent physical attack
- Steel and timber door versions available

Steel door - 703L/30S
Timber door - 703L/30T

INWARD OPENING DOORS

733L/30

Classification No.	3	7	6	B	1	3	5	1	A	D
EN 179 : 2008										

The Exidor 733L/30 offers all the functions and convenience of the Exidor three point locking emergency exit bolt, but is suitable for use on inward opening single door applications. Simply depressing the lever provides safe and speedy exit in the event of an emergency.

- Non-handed
- Surface mounted
- Adjustable top and bottom bolts
- 30mm bolt throw
- Anti-thrust bottom bolt and latch bolt to prevent physical attack
- Steel and timber door versions available

Steel door - 733L/30S
Timber door - 733L/30T



703L/30 | 733L/30

Optional accessories for the 703L/30 and 733L/30

- 709EC Outside access device with Euro cylinder – knob operated
- 709EC/NC Outside access device with Euro aperture – knob operated
- 710EC Outside access device with Euro cylinder – lever operated
- 710EC/NC Outside access device with Euro aperture – lever operated
- 705EC/LH Mechanical locking box with Euro half cylinder – left handed
- 705EC/RH Mechanical locking box with Euro half cylinder – right handed
- 705EA/LH Mechanical locking box with Euro aperture – left handed
- 705EA/RH Mechanical locking box with Euro aperture – right handed
- 705TC/LH Mechanical locking box with 80mm Euro profile double cylinder – left handed

- 705TC/RH Mechanical locking box with 80mm Euro profile double cylinder – right handed
- 705TA/LH Mechanical locking box with 80mm Euro aperture – left handed
- 705TA/RH Mechanical locking box with 80mm Euro aperture – right handed

Finishes

Available in RAL 7016, Stainless Steel Effect, Solid Stainless Steel. Other finishes available on request.

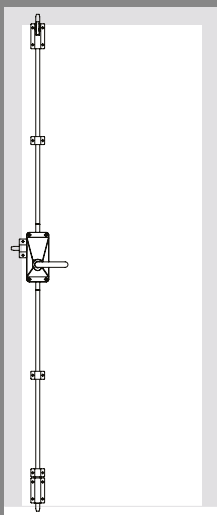

703L/30

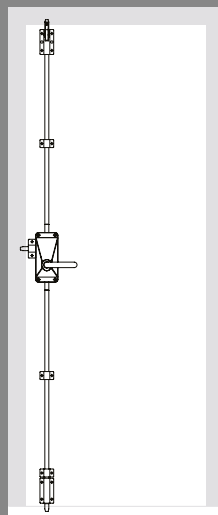

733L/30

Single Door 704L/30

BS EN 179



FOUR POINT LOCKING
OUTWARD OPENING DOORS

704L/30

Classification No.	3	7	6	B	1	3	5	1	A	A
EN 179 : 2008										

The Exidor 704L/30 is a surface mounted four point locking emergency exit bolt for outward opening single door applications. It is ideally suited to very high security applications, where emergency escape is a consideration. Incorporated as standard is an automatic top trip mechanism. Simply depressing the lever provides safe and speedy exit in the event of an emergency. The main body is constructed from a mixture of steel and stainless steel, with steel being used for the internal components and bolts. There is also an anti-thrust mechanism in the bottom bolt and the latch bolt.

- Non-handed
- Surface mounted
- Adjustable top and bottom bolts
- 30mm bolt throw
- Anti-thrust bottom bolt and latch bolt to prevent physical attack
- Steel and timber door versions available

Steel door - 704L/30S
Timber door - 704L/30T



704L/30

Optional accessories for the 704L/30

- 709EC Outside access device with Euro cylinder – knob operated
- 709EC/NC Outside access device with Euro aperture – knob operated
- 710EC Outside access device with Euro cylinder – lever operated
- 710EC/NC Outside access device with Euro aperture – lever operated
- 705EC/LH Mechanical locking box with Euro half cylinder – left handed
- 705EC/RH Mechanical locking box with Euro half cylinder – right handed
- 705EA/LH Mechanical locking box with Euro aperture – left handed
- 705EA/RH Mechanical locking box with Euro aperture – right handed
- 705TC/LH Mechanical locking box with 80mm Euro profile double cylinder – left handed
- 705TC/RH Mechanical locking box with 80mm Euro profile double cylinder – right handed

- 705TA/LH Mechanical locking box with 80mm Euro aperture – left handed
- 705TA/RH Mechanical locking box with 80mm Euro aperture – right handed

Finishes

Available in RAL 7016, Stainless Steel Effect, Solid Stainless Steel. Other finishes available on request.

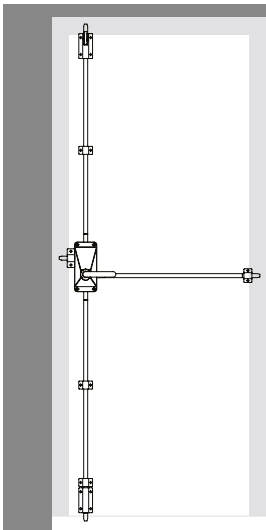

704L/30

Single Door 701B/30

BS EN 1125



SINGLE POINT LOCKING
OUTWARD OPENING DOORS

701B/30

Classification No.	3	7	6	B	1	3	2	1	A	A
EN 1125 : 2008										

The Exidor 701B/30 is a high security surface mounted panic latch for outward opening single door applications, where security is a consideration. The unit is operated by a forward thrust of the crossbar to give a speedy exit in panic situations. The main body is constructed from a mixture of steel and stainless steel, with steel being used for the internal components and bolts. There is also an anti-thrust latch mechanism in the main unit making it suitable for use in security applications.

- Handed, please refer to handing diagrams on page 27
- Surface mounted
- 30mm bolt throw
- Anti-thrust latch bolt to prevent physical attack
- Steel and timber door versions available

Steel door - 701B/30S/LH (left handed), 701B/30S/RH (right handed)
Timber door - 701B/30T/LH (left handed), 701B/30T/RH (right handed)



701B/30/RH

Additional options

- Microswitch (suffix 'MS' after the product code)

Finishes

Available in RAL 7016, Stainless Steel Effect, Solid Stainless Steel. Other finishes available on request.

Optional accessories for the 701B/30

- 709EC Outside access device with Euro cylinder – knob operated
- 709EC/NC Outside access device with Euro aperture – knob operated
- 710EC Outside access device with Euro cylinder – lever operated
- 710EC/NC Outside access device with Euro aperture – lever operated

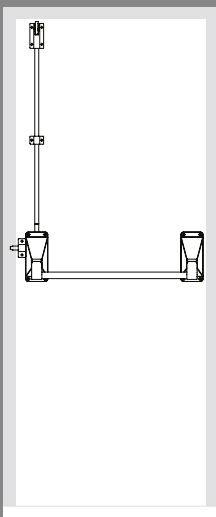

701B/30/LH

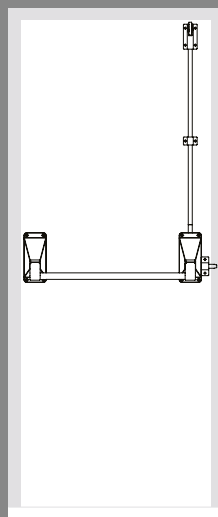

701B/30/RH

The top shoot mechanism allows for automatic re-latching, but the shoot does not enter the frame.

Single Door 702B/30

BS EN 1125



TWO POINT LOCKING
OUTWARD OPENING DOORS

702B/30

Classification No.	3	7	6	B	1	3	2	1	A	A
EN 1125 : 2008										

The Exidor 702B/30 is a high security surface mounted two point panic bolt for outward opening single door applications. Incorporated as standard is an automatic top trip mechanism. The main body is constructed from a mixture of steel and stainless steel, with steel being used for the internal components and bolts. There is also an anti-thrust mechanism in the bottom bolt making it suitable for use in high security applications.

- Non-handed
- Surface mounted
- Adjustable top and bottom bolts
- 30mm bolt throw
- Anti-thrust bottom bolt to prevent physical attack
- Steel and timber door versions available

Steel door - **702B/30S**

Timber door - **702B/30T**



702B/30

Additional options

- Microswitch (suffix 'MS' after the product code)

Optional accessories for the 702B/30

- 709EC Outside access device with Euro cylinder – knob operated
- 709EC/NC Outside access device with Euro aperture – knob operated
- 710EC Outside access device with Euro cylinder – lever operated
- 710EC/NC Outside access device with Euro aperture – lever operated
- 705EC/LH Mechanical locking box with Euro half cylinder – left handed
- 705EC/RH Mechanical locking box with Euro half cylinder – right handed
- 705EA/LH Mechanical locking box with Euro aperture – left handed
- 705EA/RH Mechanical locking box with Euro aperture – right handed
- 705TC/LH Mechanical locking box with 80mm Euro profile double cylinder – left handed

- 705TC/RH Mechanical locking box with 80mm Euro profile double cylinder – right handed
- 705TA/LH Mechanical locking box with 80mm Euro double cylinder aperture – left handed
- 705TA/RH Mechanical locking box with 80mm Euro double cylinder aperture – right handed

Finishes

Available in RAL 7016, Stainless Steel Effect, Solid Stainless Steel. Other finishes available on request.

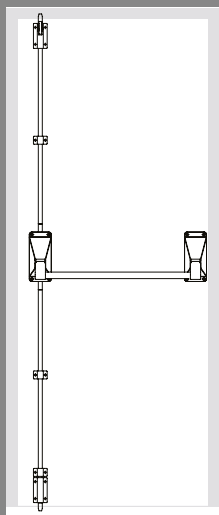

702B/30

Single Door 703B/30

BS EN 1125



THREE POINT LOCKING
OUTWARD OPENING DOORS

703B/30

Classification No.	3	7	6	B	1	3	2	1	A	A
EN 1125 : 2008										

The Exidor 703B/30 is a high security surface mounted three point panic bolt for outward opening single door applications. Incorporated as standard is an automatic top trip mechanism. The unit is operated by a forward thrust of the crossbar to give a speedy exit in panic situations. The main body is constructed from a mixture of steel and stainless steel, with steel being used for the internal components and bolts. There is also an anti-thrust mechanism in the bottom bolt and the latch bolt making it suitable for use in high security applications.

- Non-handed
- Surface mounted
- Adjustable top and bottom bolts
- 30mm bolt throw
- Anti-thrust latch bolt and bottom bolt to prevent physical attack
- Steel and timber door versions available

Steel door - 703B/30S
Timber door - 703B/30T



703B/30

Additional options

- Microswitch (suffix 'MS' after the product code)

Optional accessories for the 703B/30

- 709EC Outside access device with Euro cylinder – knob operated
- 709EC/NC Outside access device with Euro aperture – knob operated
- 710EC Outside access device with Euro cylinder – lever operated
- 710EC/NC Outside access device with Euro aperture – lever operated
- 705EC/LH Mechanical locking box with Euro half cylinder – left handed
- 705EC/RH Mechanical locking box with Euro half cylinder – right handed
- 705EA/LH Mechanical locking box with Euro aperture – left handed
- 705EA/RH Mechanical locking box with Euro aperture – right handed
- 705TC/LH Mechanical locking box with 80mm Euro profile double cylinder – left handed

- 705TC/RH Mechanical locking box with 80mm Euro profile double cylinder – right handed
- 705TA/LH Mechanical locking box with 80mm Euro double cylinder aperture – left handed
- 705TA/RH Mechanical locking box with 80mm Euro double cylinder aperture – right handed

Finishes

Available in RAL 7016, Stainless Steel Effect, Solid Stainless Steel. Other finishes available on request.

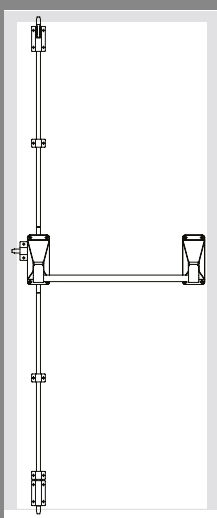

703B/30

Single Door 704B/30

BS EN 1125



FOUR POINT LOCKING
OUTWARD OPENING DOORS

704B/30

Classification No.	3	7	6	B	1	3	2	1	A	A
EN 1125 : 2008										

The Exidor 704B/30 is a surface mounted four point locking panic bolt for outward opening single door applications. It is ideally suited to very high security applications, where panic escape is a consideration. Incorporated as standard is an automatic top trip mechanism. The main body is constructed from a mixture of steel and stainless steel, with steel being used for the internal components and bolts. There is also an anti-thrust mechanism in the bottom bolt and the latch bolt.

- Non-handed
- Surface mounted
- Adjustable top and bottom bolts
- 30mm bolt throw
- Anti-thrust latch bolt and bottom bolt to prevent physical attack
- Steel and timber door versions available

Steel door - **704B/30S**
Timber door - **704B/30T**



704B/30

Additional options

- Microswitch (suffix 'MS' after the product code)

Optional accessories for the 704B/30

- 709EC Outside access device with Euro cylinder – knob operated
- 709EC/NC Outside access device with Euro aperture – knob operated
- 710EC Outside access device with Euro cylinder – lever operated
- 710EC/NC Outside access device with Euro aperture – lever operated
- 705EC/LH Mechanical locking box with Euro half cylinder – left handed
- 705EC/RH Mechanical locking box with Euro half cylinder – right handed
- 705EA/LH Mechanical locking box with Euro aperture – left handed
- 705EA/RH Mechanical locking box with Euro aperture – right handed
- 705TC/LH Mechanical locking box with 80mm Euro profile double cylinder – left handed

- 705TC/RH Mechanical locking box with 80mm Euro profile double cylinder – right handed
- 705TA/LH Mechanical locking box with 80mm Euro double cylinder aperture – left handed
- 705TA/RH Mechanical locking box with 80mm Euro double cylinder aperture – right handed

Finishes

Available in RAL 7016, Stainless Steel Effect, Solid Stainless Steel. Other finishes available on request.

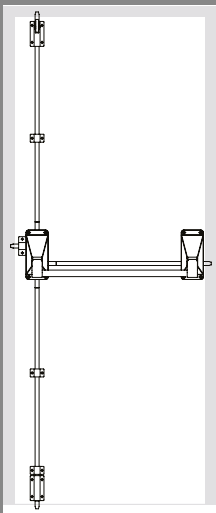

704B/30

Double Doors 701BD/30

BS EN 1125



THREE POINT LOCKING
OUTWARD OPENING DOORS

701BD/30

Classification No.	3	7	6	B	1	3	2	1	A	A
EN 1125 : 2008										

The Exidor 701BD/30 for double doors is a high security complete package consisting of a panic latch (701B/30), a two point panic bolt (702B/30) and a centre bolt keep (PHS006). The unit is certified to EN1125:2008 and is suitable for double door applications, where security is a consideration. The main body is constructed from a mixture of steel and stainless steel, with steel being used for the internal components and bolts. There is also an anti-thrust mechanism in the bottom bolt and the latch bolt making it suitable for use in security applications.

- Handed, please refer to handing diagrams on page 27
- Surface mounted
- Adjustable top and bottom bolts
- 30mm bolt throw
- Anti-thrust latch bolt and bottom bolt to prevent physical attack
- Steel and timber door versions available

Steel door - 701BD/30S/LH (left handed), 701BD/30S/RH (right handed)

Timber door - 701BD/30T/LH (left handed), 701BD/30T/RH (right handed)



701BD/30/RH

Additional options

- Microswitch (suffix 'MS' after the product code)

Optional accessories for the 701BD/30

- 709EC Outside access device with Euro cylinder – knob operated
- 709EC/NC Outside access device with Euro aperture – knob operated
- 710EC Outside access device with Euro cylinder – lever operated
- 710EC/NC Outside access device with Euro aperture – lever operated
- 705EC/LH Mechanical locking box with Euro half cylinder – left handed
- 705EC/RH Mechanical locking box with Euro half cylinder – right handed
- 705EA/LH Mechanical locking box with Euro aperture – left handed
- 705EA/RH Mechanical locking box with Euro aperture – right handed
- 705TC/LH Mechanical locking box with 80mm Euro profile double cylinder – left handed

- 705TC/RH Mechanical locking box with 80mm Euro profile double cylinder – right handed
- 705TA/LH Mechanical locking box with 80mm Euro double cylinder aperture – left handed
- 705TA/RH Mechanical locking box with 80mm Euro double cylinder aperture – right handed

Finishes

Available in RAL 7016, Stainless Steel Effect, Solid Stainless Steel. Other finishes available on request.

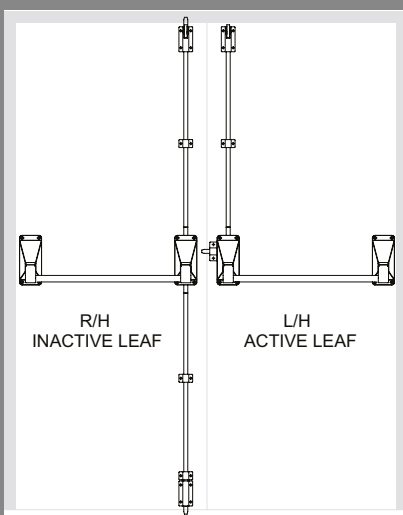

701BD/30/LH (Left Handed active)

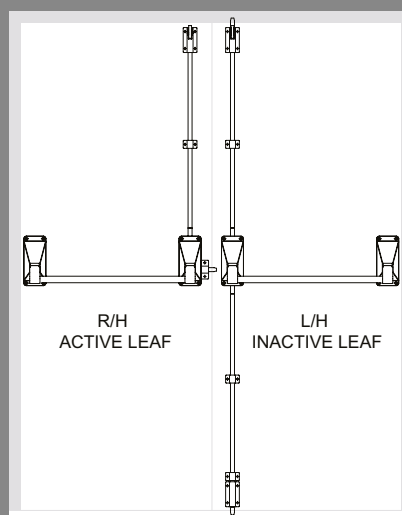

701BD/30/RH (Right Handed active)

The top shoot mechanism on single point allows for automatic re-latching, but the shoot does not enter the frame.

Rebated Double Doors 742BD/30

BS EN 1125



FOUR POINT LOCKING
OUTWARD OPENING DOORS

742BD/30

Classification No.	3	7	6	B	1	3	2	1	A	A
EN 1125 : 2008										

The Exidor 742BD/30 for rebated double doors is a high security complete package offering secure four point locking and incorporates the new horizontal locking mechanism. This allows the unit to be certified to EN1125:2008 and it is suitable for rebated double door applications where security is a consideration. The main body is constructed from a mixture of steel and stainless steel with steel being used for the internal components and bolts. There is also an anti-thrust mechanism in the horizontal bolts, increasing the products resistance to attack.

- CE Marked
- Non-handed
- Surface mounted
- Adjustable top and bottom bolts
- 30mm bolt throw
- Anti-thrust bottom and horizontal bolts to prevent physical attack

Steel door - **742BD/30S**
Timber door - **742BD/30T**



742BD/30

Additional options

- Microswitch (suffix 'MS' after the product code)

Optional accessories for the 742BD/30

- 709EC Outside access device with Euro cylinder – knob operated
- 709EC/NC Outside access device with Euro aperture – knob operated
- 710EC Outside access device with Euro cylinder – lever operated
- 710EC/NC Outside access device with Euro aperture – lever operated
- 705EC/LH Mechanical locking box with Euro half cylinder – left handed
- 705EC/RH Mechanical locking box with Euro half cylinder – right handed
- 705EA/LH Mechanical locking box with Euro aperture – left handed
- 705EA/RH Mechanical locking box with Euro aperture – right handed
- 705TC/LH Mechanical locking box with 80mm Euro profile double cylinder – left handed

- 705TC/RH Mechanical locking box with 80mm Euro profile double cylinder – right handed
- 705TA/LH Mechanical locking box with 80mm Euro double cylinder aperture – left handed
- 705TA/RH Mechanical locking box with 80mm Euro double cylinder aperture – right handed

Finishes

Available in RAL 7016, Stainless Steel Effect, Solid Stainless Steel. Other finishes available on request.

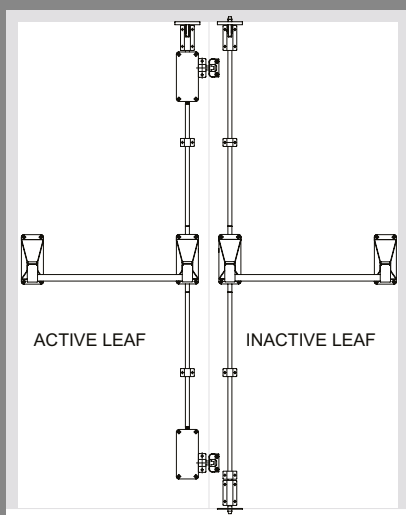

742BD/30

Rebated Double Doors 743BD/30

BS EN 1125



FIVE POINT LOCKING
OUTWARD OPENING DOORS

743BD/30

Classification No.	3	7	6	B	1	3	2	1	A	A
EN 1125 : 2008										

The Exidor 743BD/30 for rebated double doors is a complete package offering high security five point locking and incorporates the new horizontal locking mechanism. This allows the unit to be certified to EN1125:2008 and it is suitable for double door applications where a high level of security is a consideration. The main body is constructed from a mixture of steel and stainless steel with steel being used for the internal components and bolts. There is also an anti-thrust mechanism in the latch bolt and the horizontal bolts, increasing the products resistance to attack.

- CE Marked
- Non-handed
- Surface mounted
- Adjustable top and bottom bolts
- 30mm bolt throw
- Anti-thrust bottom and horizontal bolts to prevent physical attack

Steel door - 743BD/30S
Timber door - 743BD/30T



743BD/30

Additional options

- Microswitch (suffix 'MS' after the product code)

Optional accessories for the 701BD/30

- 709EC Outside access device with Euro cylinder – knob operated
- 709EC/NC Outside access device with Euro aperture – knob operated
- 710EC Outside access device with Euro cylinder – lever operated
- 710EC/NC Outside access device with Euro aperture – lever operated
- 705EC/LH Mechanical locking box with Euro half cylinder – left handed
- 705EC/RH Mechanical locking box with Euro half cylinder – right handed
- 705EA/LH Mechanical locking box with Euro aperture – left handed
- 705EA/RH Mechanical locking box with Euro aperture – right handed
- 705TC/LH Mechanical locking box with 80mm Euro profile double cylinder – left handed

- 705TC/RH Mechanical locking box with 80mm Euro profile double cylinder – right handed
- 705TA/LH Mechanical locking box with 80mm Euro double cylinder aperture – left handed
- 705TA/RH Mechanical locking box with 80mm Euro double cylinder aperture – right handed

Finishes

Available in RAL 7016, Stainless Steel Effect, Solid Stainless Steel. Other finishes available on request.

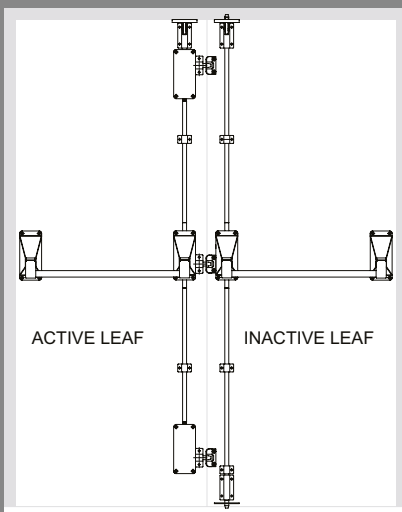

743BD/30

Double Doors 702BD/30

**This product is not CE marked and cannot be used on escape doors within the EU*



FOUR POINT LOCKING
OUTWARD OPENING DOORS

702BD/30

The Exidor 702BD/30 for double doors is a high security complete package consisting of a pair of two point panic bolts (702B/30). This unit cannot be CE marked* as it uses an overlapping crossbar system between the units. However, it is suitable for door applications, where security is a consideration. The main body is constructed from a mixture of steel and stainless steel, with steel being used for the internal components and bolts. There is also an anti-thrust mechanism in the bottom bolts making it suitable for use in high security applications.

- Non-handed
- Surface mounted
- Adjustable top and bottom bolts
- 30mm bolt throw
- Anti-thrust bottom bolts to prevent physical attack
- Steel and timber door versions available

Steel door - **702BD/30S**
Timber door - **702BD/30T**



702BD/30

Additional options

- Microswitch (suffix 'MS' after the product code)

Optional accessories for the 702BD/30

- 709EC Outside access device with Euro cylinder – knob operated
- 709EC/NC Outside access device with Euro aperture – knob operated
- 710EC Outside access device with Euro cylinder – lever operated
- 710EC/NC Outside access device with Euro aperture – lever operated
- 705EC/LH Mechanical locking box with Euro half cylinder – left handed
- 705EC/RH Mechanical locking box with Euro half cylinder – right handed
- 705EA/LH Mechanical locking box with Euro aperture – left handed
- 705EA/RH Mechanical locking box with Euro aperture – right handed
- 705TC/LH Mechanical locking box with 80mm Euro profile double cylinder – left handed

- 705TC/RH Mechanical locking box with 80mm Euro profile double cylinder – right handed
- 705TA/LH Mechanical locking box with 80mm Euro double cylinder aperture – left handed
- 705TA/RH Mechanical locking box with 80mm Euro double cylinder aperture – right handed

Finishes

Available in RAL 7016, Stainless Steel Effect, Solid Stainless Steel. Other finishes available on request.

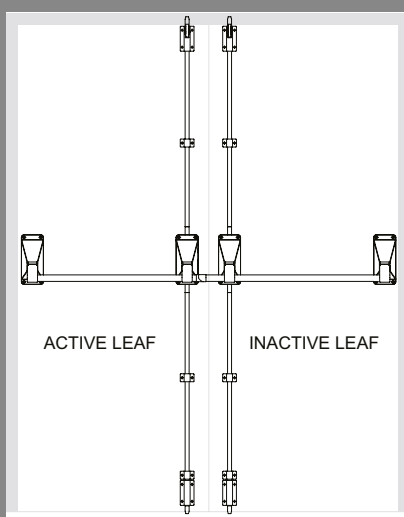

702BD/30

Double Doors 703BD/30

FIVE POINT LOCKING
OUTWARD OPENING DOORS

703BD/30

The Exidor 703BD/30 for double doors is a high security complete package consisting of a two point panic bolt (702B/30), a three point locking panic bolt (703B/30) and a centre bolt keep (PHS006). This unit cannot be CE marked* as it uses an overlapping crossbar system between the units. However, it is suitable for door applications, where security is a consideration. The main body is constructed from a mixture of steel and stainless steel, with steel being used for the internal components and bolts. There is also an anti-thrust mechanism in the bottom bolt and the latch bolt making it suitable for use in high security applications.

- Non-handed
- Surface mounted
- Adjustable top and bottom bolts
- 30mm bolt throw
- Anti-thrust bottom bolts and latch bolt to prevent physical attack
- Steel and timber door versions available

Steel door - 703BD/30S

Timber door - 703BD/30T

**This product is not CE marked and cannot be used on escape doors within the EU*



703BD/30

Additional options

- Microswitch (suffix 'MS' after the product code)

Optional accessories for the 703BD/30

- 709EC Outside access device with Euro cylinder – knob operated
- 709EC/NC Outside access device with Euro aperture – knob operated
- 710EC Outside access device with Euro cylinder – lever operated
- 710EC/NC Outside access device with Euro aperture – lever operated
- 705EC/LH Mechanical locking box with Euro half cylinder – left handed
- 705EC/RH Mechanical locking box with Euro half cylinder – right handed
- 705EA/LH Mechanical locking box with Euro aperture – left handed
- 705EA/RH Mechanical locking box with Euro aperture – right handed
- 705TC/LH Mechanical locking box with 80mm Euro profile double cylinder – left handed

- 705TC/RH Mechanical locking box with 80mm Euro profile double cylinder – right handed
- 705TA/LH Mechanical locking box with 80mm Euro double cylinder aperture – left handed
- 705TA/RH Mechanical locking box with 80mm Euro double cylinder aperture – right handed

Finishes

Available in RAL 7016, Stainless Steel Effect, Solid Stainless Steel. Other finishes available on request.

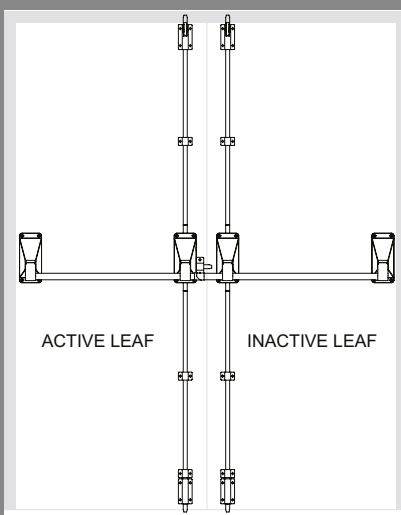

703BD/30

Double Doors 704BD/30

**This product is not CE marked and cannot be used on escape doors within the EU*



SEVEN POINT LOCKING
OUTWARD OPENING DOORS

704BD/30

The Exidor 704BD/30 for double doors is a complete high security package consisting of a four point locking panic bolt (704B/30), a reverse three point locking panic bolt (703B/30) and a centre bolt keep (PHS006). This unit cannot be CE marked* as it uses an overlapping crossbar system between the units. However, it is suitable for door applications, where security is a consideration. The main body is constructed from a mixture of steel and stainless steel, with steel being used for the internal components and bolts. There is also an anti-thrust mechanism in the bottom bolts and the latch bolt making it suitable for use in very high security applications.

- Non-handed
- Surface mounted
- Adjustable top and bottom bolts
- 30mm bolt throw
- Anti-thrust bottom bolts and latch bolt to prevent physical attack
- Steel and timber door versions available

Steel door - 704BD/30S

Timber door - 704BD/30T



704BD/30

Additional options

- Microswitch (suffix 'MS' after the product code)

Optional accessories for the 704BD/30

- 709EC Outside access device with Euro cylinder – knob operated
- 709EC/NC Outside access device with Euro aperture – knob operated
- 710EC Outside access device with Euro cylinder – lever operated
- 710EC/NC Outside access device with Euro aperture – lever operated
- 705EC/LH Mechanical locking box with Euro half cylinder – left handed
- 705EC/RH Mechanical locking box with Euro half cylinder – right handed
- 705EA/LH Mechanical locking box with Euro aperture – left handed
- 705EA/RH Mechanical locking box with Euro aperture – right handed
- 705TC/LH Mechanical locking box with 80mm Euro profile double cylinder – left handed

- 705TC/RH Mechanical locking box with 80mm Euro profile double cylinder – right handed
- 705TA/LH Mechanical locking box with 80mm Euro double cylinder aperture – left handed
- 705TA/RH Mechanical locking box with 80mm Euro double cylinder aperture – right handed

Finishes

Available in RAL 7016, Stainless Steel Effect, Solid Stainless Steel. Other finishes available on request.

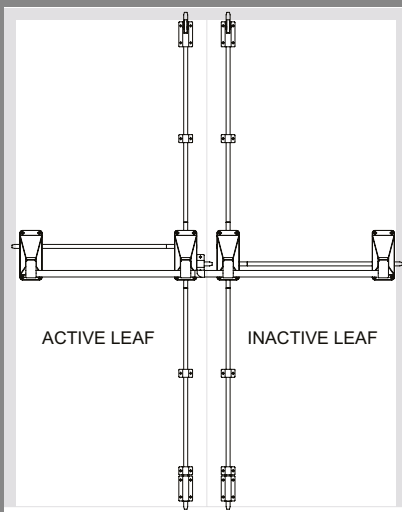

704BD/30

High Security Automatic Deadlocking Multi-Point Lock with Handle



New to the 700 series range is the Exidor automatic deadlocking multi-point lock with lever handle. Designed for use in applications such as ATM rooms, the multi-point lock automatically deadlocks when the door shuts, ensuring that a key or thumb turn is always required to open the door. The deadlocking box uses an offset thumb turn Euro profile cylinder. This product is unsuitable for use on doors where panic and emergency exit may be required. The product is supplied complete with a locking box and two, three or four point lock with lever handle. Please note that this product is handed according to the illustrations on page 27.

Performance

The unit will automatically deadlock when the door closes, ensuring a high level of security. The key or thumb turn is always required to unlock the mechanism from either side to allow the door to be opened.

Two Point Locking With Euro Profile Thumb Turn Cylinder:

Steel door **702L/30S/DEC/LH (left handed), 702L/30S/DEC/RH (right handed)**

Timber door **702L/30T/DEC/LH (left handed), 702L/30T/DEC/RH (right handed)**

Two Point Locking With Euro Profile Aperture:

Steel door **702L/30S/DEA/LH (left handed), 702L/30S/DEA/RH (right handed)**

Timber door **702L/30T/DEA/LH (left handed), 702L/30T/DEA/RH (right handed)**

Three Point Locking With Euro Profile Thumb Turn Cylinder:

Steel door **703L/30S/DEC/LH (left handed), 703L/30S/DEC/RH (right handed)**

Timber door **703L/30T/DEC/LH (left handed), 703L/30T/DEC/RH (right handed)**

Three Point Locking With Euro Profile Aperture:

Steel door **703L/30S/DEA/LH (left handed), 703L/30S/DEA/RH (right handed)**

Timber door **703L/30T/DEA/LH (left handed), 703L/30T/DEA/RH (right handed)**

Four Point Locking With Euro Profile Thumb Turn Cylinder:

Steel door **704L/30S/DEC/LH (left handed), 704L/30S/DEC/RH (right handed)**

Timber door **704L/30T/DEC/LH (left handed), 704L/30T/DEC/RH (right handed)**

Four Point Locking With Euro Profile Aperture:

Steel door **704L/30S/DEA/LH (left handed), 704L/30S/DEA/RH (right handed)**

Timber door **704L/30T/DEA/LH (left handed), 704L/30T/DEA/RH (right handed)**



705 DEC/RH

Outside Access Devices



All the Exidor 700 series Outside Access Devices (OAD's) have been certified for use with the Exidor 700 series range of high security panic and emergency exit hardware. The use of any other OAD will invalidate the CE marking on these products.

709 Knob Operated Outside Access Device

The Exidor 709 is supplied either with or without cylinder, and has the advantage that a high security master keyed 45mm half Euro profile cylinder can be used. Suitable for use with the Exidor 700 series, this OAD is manufactured from stainless steel which helps prevent force and drill attack, and incorporates cylinder protection to prevent manipulation.

- Non-handed
- Suitable for high security applications
- Surface mounted on the outside of the door using concealed machine screws
- Available with or without cylinder
- When ordered with the cylinder, three keys are supplied as standard
- Supplied as standard for doors up to 45mm thick
- Longer spindles available on request for door thicknesses over 45mm

Performance

When locked, the mechanism is disengaged allowing the knob to rotate freely. When unlocked, the knob, spindle and mechanism engage allowing the bolts to be withdrawn from the outside. The knob remains engaged until it is re-locked.



709EC



709EC/NC

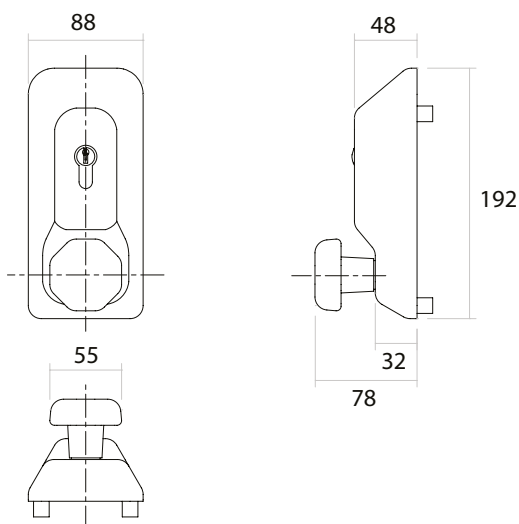

All measurements in mm

Finishes

Available in RAL 7016 and Solid Stainless Steel. Other finishes available on request.

Outside Access Devices

CE



All the Exidor 700 series Outside Access Devices (OAD's) have been certified for use with the Exidor 700 series range of high security panic and emergency exit hardware. The use of any other OAD will invalidate the CE marking on these products.

710 Lever Operated Outside Access Device

The Exidor 710 is supplied either with or without cylinder, and has the advantage that a high security master keyed 45mm half Euro profile cylinder can be used. Suitable for use with the Exidor 700 series, this OAD is manufactured from stainless steel which helps prevent force and drill attack, and incorporates cylinder protection to prevent manipulation.

- Non-handed
- Meets the dimensional requirements of BS8300 and approved Document "M" (Equality Act)
- Suitable for high security applications
- Surface mounted on the outside of the door using concealed machine screws
- Available with or without cylinder
- When ordered with the cylinder, three keys are supplied as standard
- Supplied as standard for doors up to 45mm thick
- Longer spindles available on request for door thicknesses over 45mm



710EC

Performance

When locked, the mechanism is disengaged allowing the lever to move freely. When unlocked, the lever, spindle and mechanism engage allowing the bolts to be withdrawn from the outside. The lever remains engaged until it is re-locked.

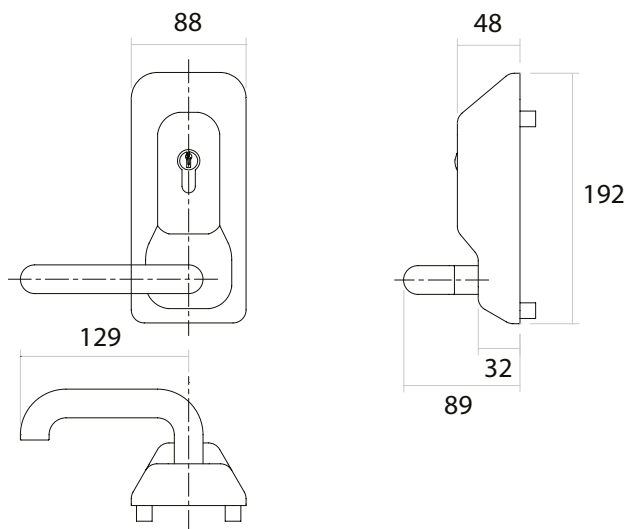

710EC/NC

Finishes

Available in RAL 7016 and Solid Stainless Steel. Other finishes available on request.

All measurements in mm

In the unlocked position this product meets all the requirements of EN179 and EN1125 when fitted to panic and emergency hardware. However, when locked it will invalidate the CE marking of the panic hardware. Please check with local laws and fire authorities to ensure compliance with local requirements and ensure a safe system of work is in place.

705 Locking Box

The Exidor 705 locking box allows the Exidor 700 series range of heavy duty panic, emergency and high security locking products to be deadlocked. This enhances the security of the products from outside the door and also ensures that the door cannot be opened, even if being attacked from the inside. The locking box has both anti drill and anti force plates incorporated into its design to increase security, has the option of using a 40mm half Euro profile cylinder, an offset Euro profile double cylinder or an offset Euro profile thumbturn cylinder and comes complete with a back plate to ensure easy installation. There is also a visual indicator to show if it's locked or unlocked. Please note that this product is handed according to the illustrations on page 27.

Performance

Turning the key will engage the locking box and ensure that the Exidor 700 series bolts are deadlocked and cannot be opened by depressing the lever or the bar. A red indicator panel shows that the locking box is in the locked status. The key is required to unlock the mechanism and the indicator panel will now show white to indicate that the 700 series bolts are active.



705 EC/RH

705EC/LH Locking box with 40mm Euro profile half cylinder – left handed

705EC/RH Locking box with 40mm Euro profile half cylinder – right handed

705EA/LH Locking box with 40mm Euro profile half cylinder aperture – left handed

705EA/RH Locking box with 40mm Euro profile half cylinder aperture – right handed

705TC/LH Locking box with security escutcheon, with an offset Euro profile double cylinder – left handed

705TC/RH Locking box with security escutcheon, with an offset Euro profile double cylinder – right handed

705TA/LH Locking box with security escutcheon, suitable for use with an offset Euro profile double cylinder, (not supplied) – left handed

705TA/RH Locking box with security escutcheon, suitable for use with an offset Euro profile double cylinder, (not supplied) – right handed

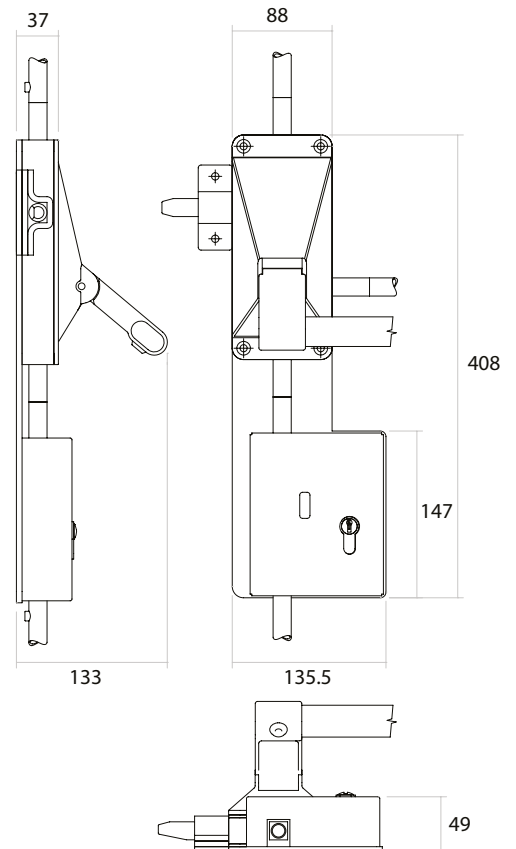

All measurements in mm

707 Heavy Duty Escutcheon

The Exidor 707 high security escutcheon is designed for use with the 705 range of locking boxes. It is fitted over the Euro profile cylinder used with these products and offers protection against a physical attack on the outside of the door. Manufactured from hardened steel, the 707 is concealed fixed by bolting through from the locking box and provides protection against drilling.



707

Heavy Duty Tower Bolts

Epoxy powder coated with electro galvanised 19mm diameter steel shoot bolts, the heavy duty tower bolt range is designed to complement the Exidor 700 series high security bolts and panic and emergency hardware.

Ranging from 10" to 36" in length, the bolts are suitable for both steel and timber door applications and there is a full range of keeps available.

Heavy duty hexagonal head screw bolts are supplied for fixing

HS923/10 10" heavy duty tower bolt with standard keep for steel or timber flush doors and frames

HS924/10 10" heavy duty tower bolt with angled keep to suit outward opening doors with a timber frame and a 12mm recess

HS925/10 10" heavy duty tower bolt with angled keep to suit outward opening doors with a timber frame and a 19mm recess

HS926/10 10" heavy duty tower bolt with keep to suit inward opening doors with a timber frame

HS923/36 36" heavy duty tower bolt with standard keep for steel or timber flush doors and frames

Heavy Duty Tower Bolt Keeps

PHS001 Standard keep to suit steel or timber flush doors and frames

PHS002 Angled keep to suit outward opening doors with timber frames and a 12mm recess

PHS003 Angled keep to suit outward opening doors with timber frames and a 19mm recess

PHS004 Keep to suit inward opening doors with a timber frame

PHS005 Flat floor keep

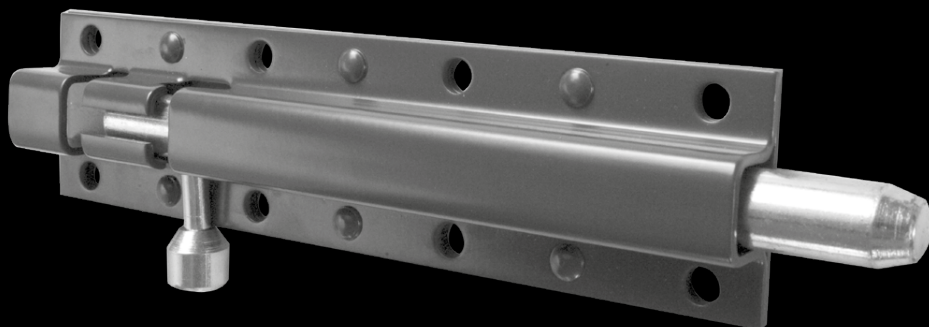

Heavy Duty Tower Bolt

TIMBER & STEEL DOOR KEEPS

Latch Bolt and 4th Point Side Keeps

P6102 Standard Latch / Hinge Bolt Keep

- Supplied as standard with the 701L/30, 703L/30, 704L/30, 704BD/30, 701B/30, 703B/30, 704B/30, 713L/30 and 714L/30

Construction - mild steel | Finish - powder coated

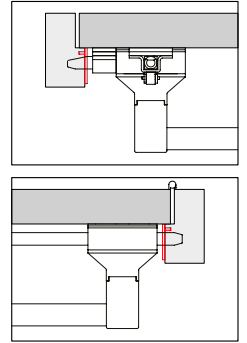

P6102

PHS006 Double Door Keep

- Supplied as standard with the 701BD/30, 703BD/30, 742BD/30, 743BD/30, 704BD/30 and 733L/30

Construction - mild steel | Finish - powder coated

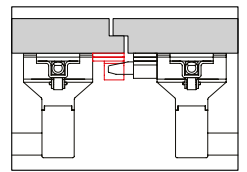
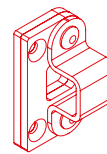

PHS006

Top Bolt Keeps

P6104 Standard Top Trip Keep

- Supplied as standard with the 702L/30, 703L/30, 704L/30, 702B/30, 703B/30, 704B/30, 701BD/30, 702BD/30, 703BD/30, 742BD/30, 743BD/30, 704BD/30, 712L/30, 713L/30 and 714L/30

Construction - mild steel | Finish - powder coated

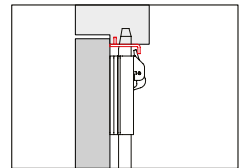
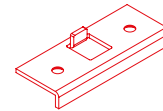

P6104

P6146 Standard Top Trip Plate for Single Point Devices

- Supplied as standard with the 701L/30, 701B/30 and 701BD/30
- No clearance hole in the frame is required

Construction - mild steel | Finish - powder coated

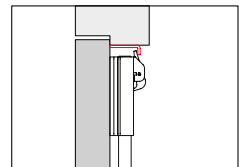
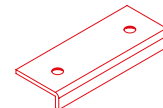

P6146

Bottom Bolt Keeps

P6102 Standard Flat Bottom Keep

- Supplied as standard with the 702L/30, 732L/30, 703L/30, 733L/30, 704L/30, 702B/30, 703B/30, 704B/30, 701BD/30, 702BD/30, 703BD/30, 704BD/30, 742BD/30, 743BD/30, 712L/30, 713L/30 and 714L/30

Construction - mild steel | Finish - powder coated

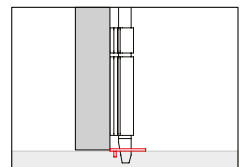
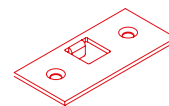

P6102

P0301 Easy Clean Floor Socket

Construction - cast iron | Finish - zinc plated

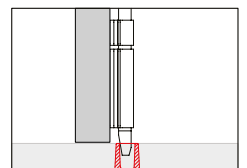
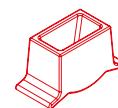

P0301

3405 Surface Mounted Bottom Keep

- Surface mounted keep for bottom shoot bolts
- No clearance hole in the floor is required

Construction - diecast zinc alloy | Finish - zinc plated

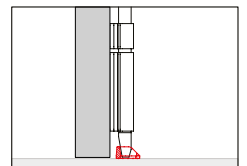

3405

Technical Data

Maintenance

It is important that all heavy duty high security locks, bolts and panic and emergency exit hardware devices are inspected and maintained properly to maintain performance and ensure safety when exiting a building in any situation.

Once the device is fitted regular maintenance is recommended.

Weekly:

- Make sure the exit device functions correctly
- Any fixings that have worked loose should be re-secured
- Any damaged components should be replaced
- Ensure there are no obstructions which prevent the panic emergency exit unit from functioning correctly

Every three months:

- Check for wear. Any visible worn components should be replaced

Fixing / Installation

Installation instructions are supplied with all the Exidor heavy duty high security locks, bolts and panic and emergency exit hardware. Provided the instructions are followed and the units are fitted by a competent person, the Exidor range will offer a high degree of safety and security. **No responsibility can be accepted by the manufacturer if the installation instructions are not followed.**

In order to meet the CEN European standards the door and frame should be of good quality and suitable to support the hardware.

Make sure that any weather strips or fixings on the door or frame do not interfere with the opening and closing of the door.

All bars and shoot bolts should be cut to the exact size on site and each is supplied with loose end plugs. Unless specified the Exidor range is supplied with all the necessary fixings for timber or steel frames and doors. However, for alternative fixings, please contact the manufacturer or your supplier.

Construction

The main body and slave units are constructed from a mixture of steel and stainless steel. The internal components are manufactured from steel and shoot ends are of solid steel with tubular steel rods.

Standard Sizes

Standard sized units are suitable for doors up to 1220mm wide and 2440mm high. The shoot bolts and cross bars can be cut down on site to suit the door height and width.

For larger doors above 2440mm high special size top shoot bolt lengths are available up on request. The following lengths are stocked by Exidor Ltd.

- 1210mm for doors up to 2440mm high (Standard size supplied)
- 1600mm for doors up to 2680mm high
- 2100mm for doors up to 3180mm high

Handing

The following diagrams identify if you require a left handed or right handed product, where applicable:

SINGLE DOORS OUTWARD OPENING

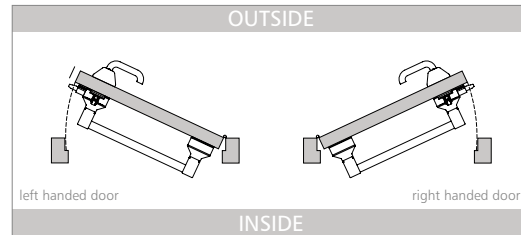

SINGLE DOORS INWARD OPENING

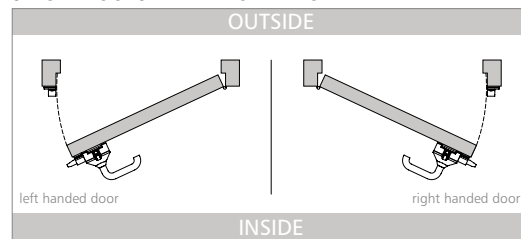

DOUBLE DOORS OUTWARD OPENING

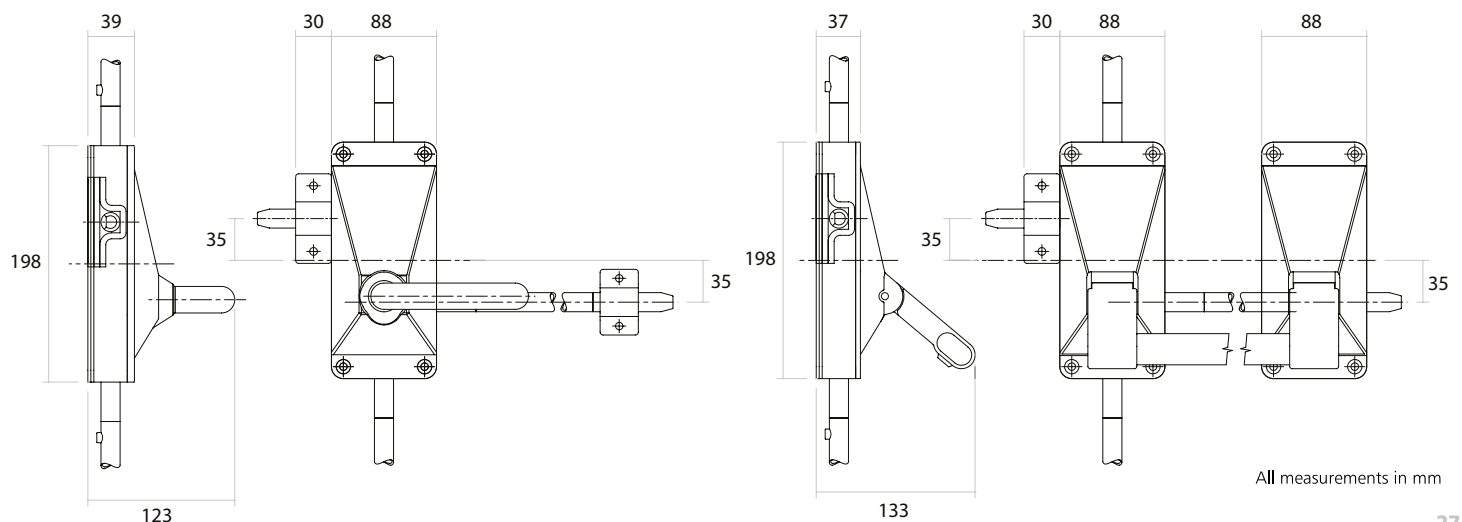
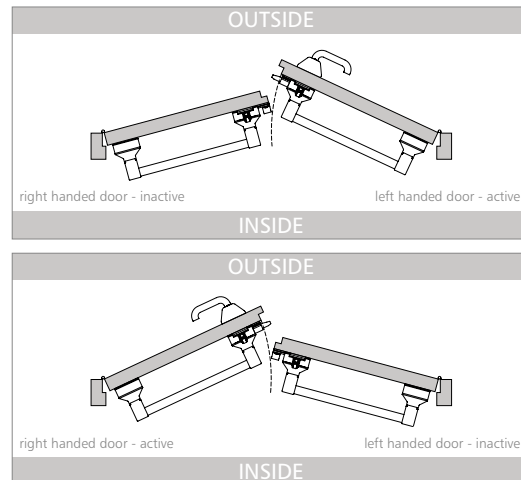

All measurements in mm

Parts List

1. Panic Push bar
2. Top Shoot Tube
3. Bottom Shoot Tube
4. Guide
5. Top Trip Guide Assembly
6. Bottom Guide
7. Bottom Keep Plate
8. Push Bar Mechanism Unit
9. Push Bar Slave Unit
10. Push Bar Arm Front Plate Assembly
11. Push Bar Slave Front Plate Assembly
12. 4th Locking Point Shoot Tube
13. Top Shoot Bolt
14. Bottom Shoot Bolt
15. Latch Keep
16. 4th Locking Point Keep
17. Top Trip Plate
18. 4th Locking Point Shoot Bolt
19. Tube Screws
20. Lever Handle Mechanism Unit
21. Lever Handle Front Plate Assembly
22. Latch Bolt Supporting Strap

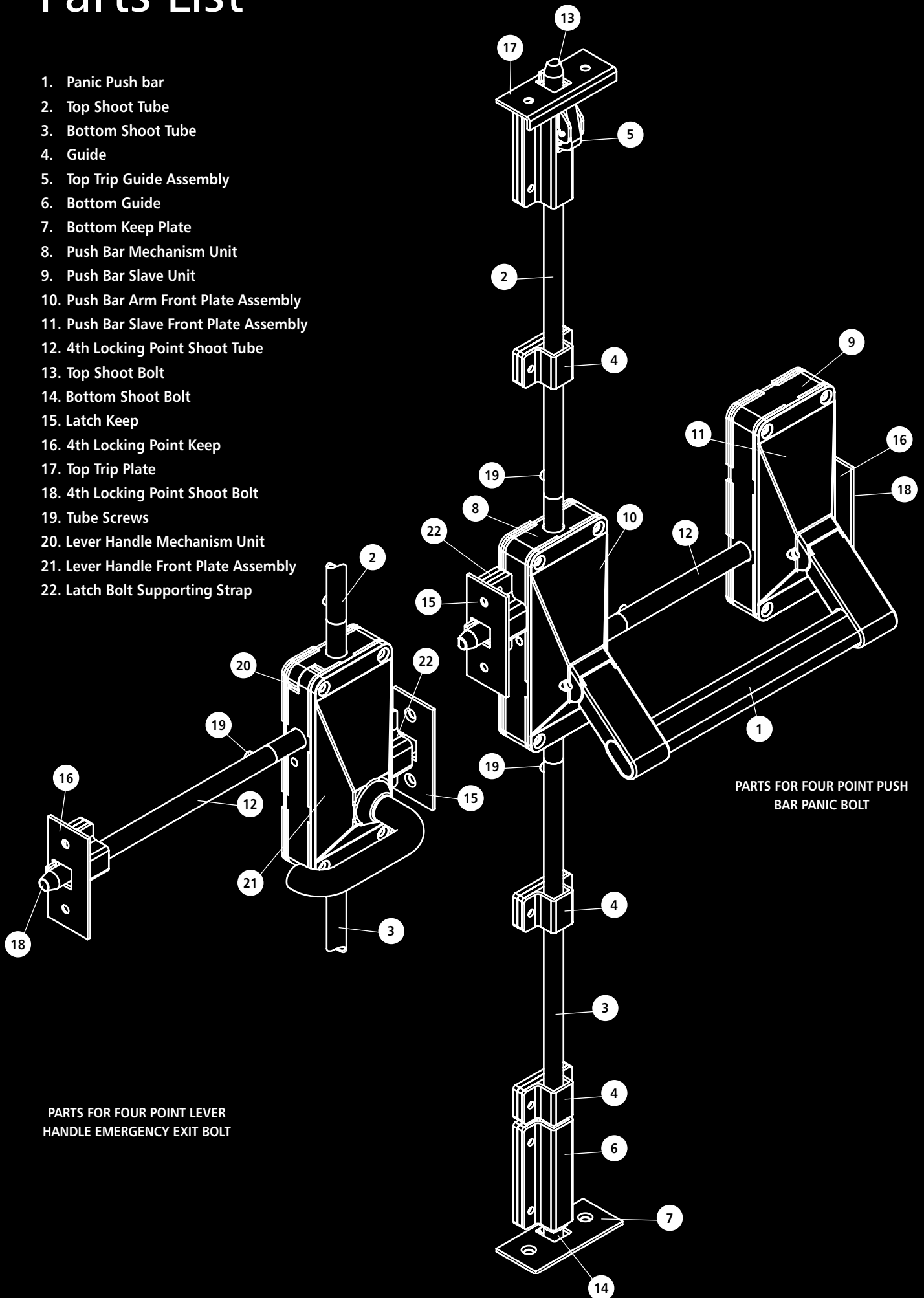

PARTS FOR FOUR POINT PUSH BAR PANIC BOLT

PARTS FOR FOUR POINT LEVER HANDLE EMERGENCY EXIT BOLT

Regulations

The two standards for panic and emergency exit hardware are as follows:-

EN179: 2008

For push pad and lever handle devices which can only be used in areas where occupants of the building are familiar with the layout and means of escape, and where members of the public do not have access.

Application examples: factory, warehouse, offices



EN1125: 2008

For push bar and touch bar devices which can be used in any environment, particularly areas open to members of the public.

Application examples: shopping centres, areas of entertainment, public buildings



Classification Coding System for Panic and Emergency Exit Hardware

Under both these two standards each product is tested and classified accordingly to show its compliance by the identification of a 10-digit code that is visible on the product and fitting instructions. Each digit represents a category and how it measured against the standard to which it was tested.

Example:

Digit: 1 2 3 4 5 6 7 8 9 10

Classification No.	3	7	6	B	1	3	2	2	A	A
--------------------	---	---	---	---	---	---	---	---	---	---



Digit 1 - Category of Use

Only one category is identified

3 = high frequency of use where there is little incentive to exercise care, i.e. where there is a chance of an accident occurring and misuse.

Example: Doors to shops, hospitals, schools and other buildings which provide access to designated areas and which are used by the public and others frequently carrying or propelling bulky objects.

Digit 2 - Durability

6 = tested up to 100,000 cycles

7 = tested up to 200,000 cycles

Digit 3 - Door Mass

5 = for doors up to 100kg

6 = for doors up to 200kg

7 = for doors over 200kg

Digit 4 - Suitability for use on fire / smoke doors

0 = not approved for use on fire / smoke door assemblies

A = suitable for use on smoke door assemblies

B = Suitable for use on fire and smoke door assemblies based on a test in accordance with EN1634-1

Digit 5 - Safety

Only the top grade is allowed on panic and emergency exit hardware

1 = safety

Digit 6 - Corrosion Resistance to EN 1670

3 = high resistance

4 = very high resistance

Digit 7 - Security for Products

EN 1125

2 = 1,000 N - this is the grade allowed under EN 1125

EN 179

2 = 1,000N / 3 = 2,000N / 4 = 3,000N / 5 = 5,000N

These four grades are used to allow the opportunity of greater security because these devices are subject to testing with doors under a greater pressure.

Digit 8 - Projection of Device

1 = large projection (projection of 150mm from the face of the door)

2 = standard projection (projection of 100mm from the face of the door)

Digit 9 - Type of Device

EN 179

A = emergency device using a lever handle

B = emergency device using a push pad

EN 1125

A = panic device using a push bar

B = panic device using a touch bar

Digit 10 - Door Application

EN 179

A = outwardly opening single exit door, double exit door: active or inactive leaf

B = outwardly opening single exit door only

C = outwardly opening double exit door: inactive leaf only

D = inwardly opening single exit door only

EN 1125

A = single door, double door: active or inactive leaf

B = single door only

C = double door: inactive leaf only

Glossary

Emergency Exit Hardware

Products that are classified as emergency exit hardware offer a single operation of a lever or push pad to release the device. These are certified to EN179 and can be used on premises that require prior knowledge of its operation and where panic situations are not foreseen, such as offices and areas that are not open to the public.

Panic Exit Hardware

Products that are classified as panic exit hardware offer a single operation of a push bar or touch bar to release the device. These are certified to EN1125 and can be used on premises that do not require prior knowledge of its operation and where panic situations are foreseen, such as places of entertainment, public buildings and areas open to the public.

Rebated Doors

A pair of double doors that are rebated.

Non-Rebated Doors

A pair of double doors that are flush fitting.

Mechanism Unit

This is the main unit that controls the travel of the bolts and latches.

Automatic Top Trip

Device used to hold the bolts in the withdrawn position when the door is open. When the door is closed too, the automatic top trip releases the bolts securing the door.

Anti-thrust

A device built into a unit to prevent either a bolt or latch from being forced back when in the closed position, thus increasing the level of security.

Adjustable Shoots

To overcome the problem of bolts not fully engaging in the keeps due to the door or frame moving after a period of time, adjustable shoots are available on Exidor panic bolts. They allow ± 5 mm of adjustment, and are particularly suited for soft wood, UPVC and steel doors.

Slave Unit

The slave unit supports the cross bar on any panic hardware.

Micro Switch

For situations that require the panic hardware to be linked to a monitoring or alarm system a micro switch can be fitted in the slave unit. The micro switch closes an electrical circuit when the cross bar is operated.

Multi Bolt

The high security multi-bolt is a deadlocking option for use where panic or emergency escape is not required.

When activated, the unit is deadlocked to prevent access from the outside, and is only released by withdrawal of the deadbolt by the key/turn of the nightlatch lever.

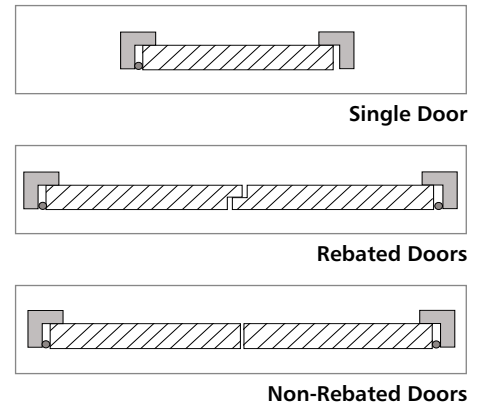

Product Features

Single doors

Product No.	Description	EN Standard		Door Type (opening)		CE Mark	Fire Rated	Steel Door Fixings	Timber Door Fixings	Deadlocking Function	Locking Points
		179	1125	Inward	Outward						
701B/30T	Push bar single panic latch		●		●	●	●		●		1
701B/30S	Push bar single panic latch		●		●	●	●	●			1
701L/30T	Lever operated single emergency exit latch	●			●	●	●		●		1
701L/30S	Lever operated single emergency exit latch	●			●	●	●	●			1
702B/30T	Push bar single panic bolt		●		●	●	●		●		2
702B/30S	Push bar single panic bolt		●		●	●	●	●			2
702L/30T	Lever operated single emergency exit bolt	●			●	●	●		●		2
702L/30S	Lever operated single emergency exit bolt	●			●	●	●	●			2
732L/30T	Lever operated single emergency exit bolt	●		●		●	●		●		2
732L/30S	Lever operated single emergency exit bolt	●		●		●	●	●			2
703B/30T	Push bar three point panic bolt		●		●	●	●		●		3
703B/30S	Push bar three point panic bolt		●		●	●	●	●			3
703L/30T	Lever operated three point emergency exit bolt	●			●	●	●		●		3
703L/30S	Lever operated three point emergency exit bolt	●			●	●	●	●			3
733L/30T	Lever operated three point emergency exit bolt	●		●		●	●		●		3
733L/30S	Lever operated three point emergency exit bolt	●		●		●	●	●			3
704B/30T	Push bar four point panic bolt		●		●	●	●		●		4
704B/30S	Push bar four point panic bolt		●		●	●	●	●			4
704L/30T	Lever operated four point emergency exit bolt	●			●	●	●		●		4
704L/30S	Lever operated four point emergency exit bolt	●			●	●	●	●			4
712L/30T	Lever operated high security two point multi-bolt				●				●	●	2
712L/30S	Lever operated high security two point multi-bolt				●			●		●	2
713L/30T	Lever operated high security three point multi-bolt				●				●	●	3
713L/30S	Lever operated high security three point multi-bolt				●			●		●	3
714L/30T	Lever operated high security four point multi-bolt				●				●	●	4
714L/30S	Lever operated high security four point multi-bolt				●			●		●	4

Double Doors

Product No.	Description	EN Standard		Door Type (opening)		CE Mark	Fire Rated	Steel Door Fixings	Timber Door Fixings	Deadlocking Function	Locking Points
		179	1125	Inward	Outward						
701BD/30T	Three Point Locking double door set		●		●	●	●		●		3
701BD/30S	Three Point Locking double door set		●		●	●	●	●			3
742BD/30T	Four point locking CE marked double door set		●		●	●	●		●		4
742BD/30S	Four point locking CE marked double door set		●		●	●	●	●			4
702BD/30T	Four point locking double door set				●				●		4
702BD/30S	Four point locking double door set				●			●			4
743BD/30T	Five point locking CE marked double door set		●		●	●	●		●		5
743BD/30S	Five point locking CE marked double door set		●		●	●	●	●			5
703BD/30T	Five point locking double door set				●				●		5
703BD/30S	Five point locking double door set				●			●			5
704BD/30T	Seven point locking double door set				●				●		7
704BD/30S	Seven point locking double door set				●			●			7

Find It Fast!

You don't need to trawl through catalogues any more. Just use the product specifiers on our new website to take you straight to the specific product you want.

exidor.co.uk



EXIDOR

www.exidor.co.uk

Exidor Limited
Progress Drive, Cannock
Staffordshire, WS11 0JE
England, UK

Tel: +44 (0)1543 578661
Fax: +44 (0)1543 570050
Email: sales@exidor.co.uk



1121
AAA024
EN 1125: 2008
37601321AA

Uniclass L4181	EPIC D181
CI/SfB (31.59)	X

Issue 3 EX405

A subsidiary of
chamberlin plc

Every effort has been made to ensure the accuracy of the particulars contained in this brochure. All details and specifications were deemed correct at time of going to press. However, Exidor Limited reserve the right to alter specifications with or without prior notice and at such times in a manner they think fit. Customers are advised to call Exidor Limited on +44 (0) 1543 578661 if they require further details or clarification of specifications.