

ES34/35 Espagnolette Bolt Fitting Instructions

Pre-Assembly Notes

Note 1.

We recommend that you assemble the bolts to the centre module of this product on a flat surface such as work bench or floor, check required dimensions and cut to size before fixing to your door. There is one 6.25mm hole in the end of each of these bolts, if/when you have to reduce the length of these bolts this 6.25mm hole must not be cut off, any adjustment should be made from the opposite end. Extra-long bolts measuring 1800mm are available at an extra cost should your door height require them.

Note 2.

The length of the bolts for inward opening doors can be to the top and bottom edges of your door, plus, if you desire, any extra for unusual gaps, as long as they do not foul the door frame or floor when the door is opened or closed. For outward opening doors the bolts will need to be shorter than the overall door height to make allowance for rebates within the frame.

Note 3.

Joinery sections vary considerably, there are three different keeps supplied with this product but due to the variety of joinery sections available some adjustments to your particular joinery may be necessary. Also supplied are two shims, these are flat and of the same profile as the saddles that hold the bolts to your door, for outward opening doors the most likely suitable strike plate will be the angle plate, the shims should, if necessary, be fitted behind the top and bottom saddles to help guide the bolts into the slot in the angle keep, the position of these saddles is determined by the fitter as it will have to suit your particular joinery sections.

Note 4.

Always drill pilot holes for fixing screws.

ES34/35 Espagnolette Bolt Fitting Instructions

Parts List

Please check that all parts are included before beginning assembly.

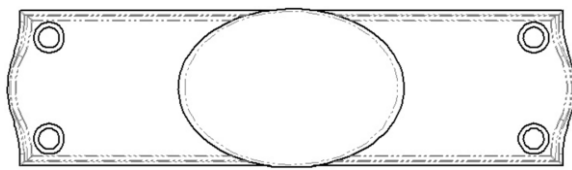

1 x Centre Module

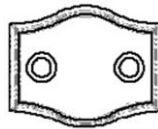

2 x End Saddle

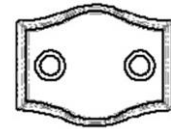

3 x Centre Bolt Saddle

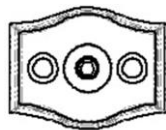
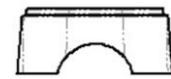
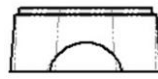

1 x Lock Saddle

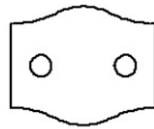

2 x Shim

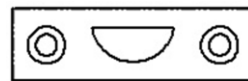

1 x Flat Keep

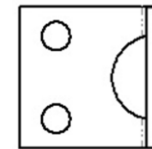

2 x Angle Keep

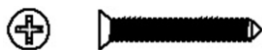
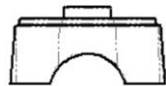

4 x 30mm Screw



4 x 38mm Screw



12 x 30mm Screw



2 x 16mm Screw

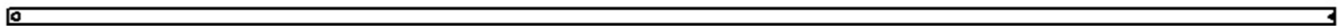

2 x 1.2m Bolt

ES34/35 Espagnolette Bolt Fitting Instructions

1. Measure the 'sight' size of your door, taking into account any unusual gaps that there may be at the top and bottom, and determine your preferred position for the centre module.
Note. It is important that when the bolts are fixed to the door they do not foul your door frame or floor when the door is opened or closed but that they are long enough to enter the locking keeps when the product is used.

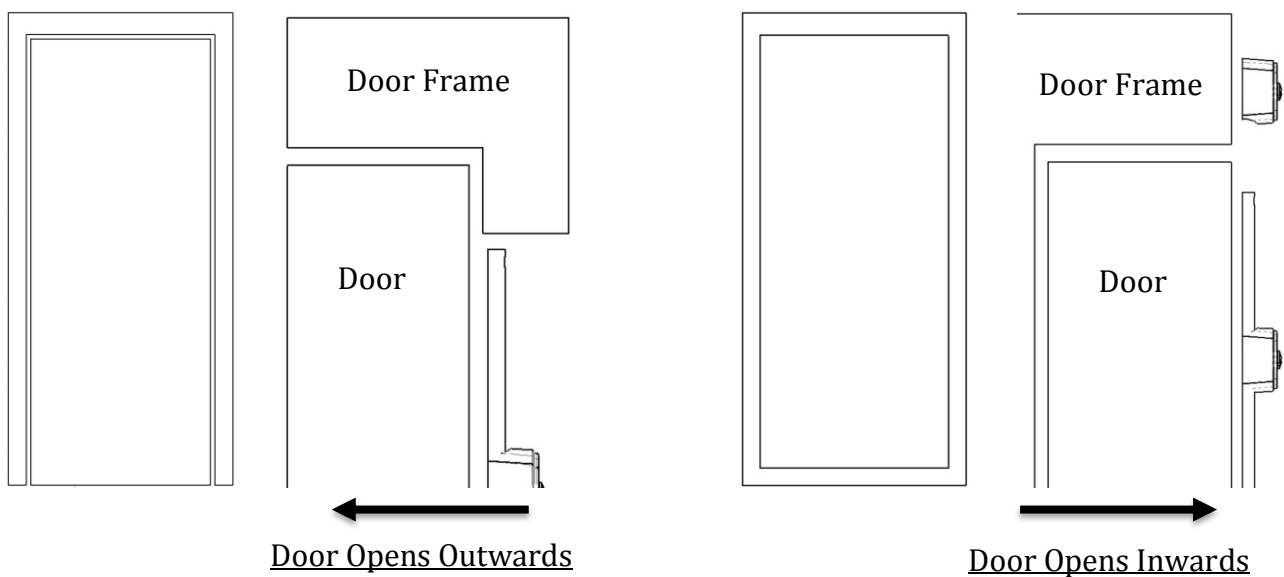

2. Ensure that the centre module is in the un-bolted position by turning the knob in an anti-clockwise direction i.e. with the two sliding levers withdrawn into the mechanism.

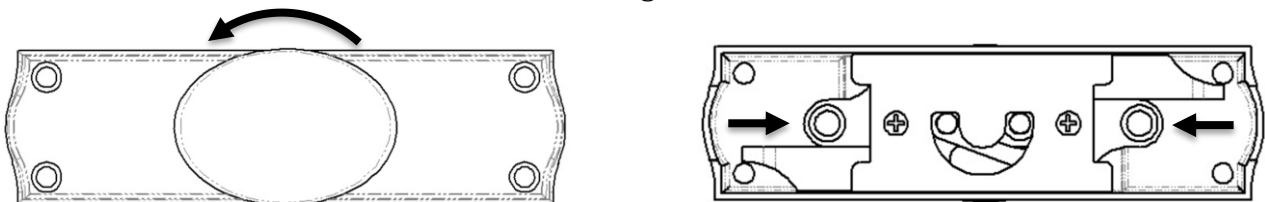

ES34/35 Espagnolette Bolt Fitting Instructions

3. Connect one bolt to the mechanism by positioning one of the pins on the rear of the centre module into the 6.25mm hole in the bolt, measure the length you require this bolt to be, remove and cut to length, repeat this procedure for the other bolt.

Note. Please be sure you have measured accurately, if un-sure offer the parts to the door before making any reductions.

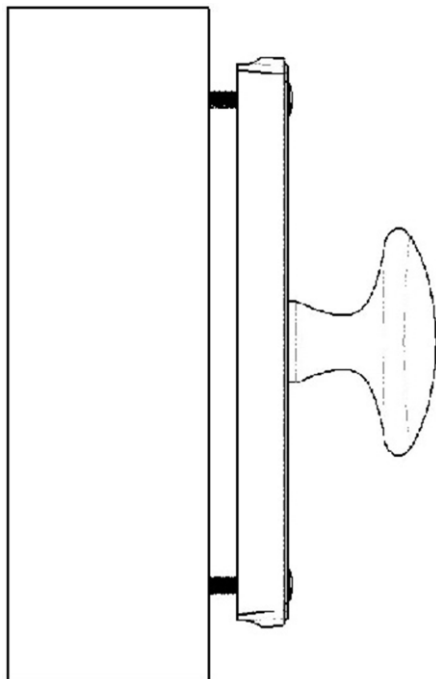
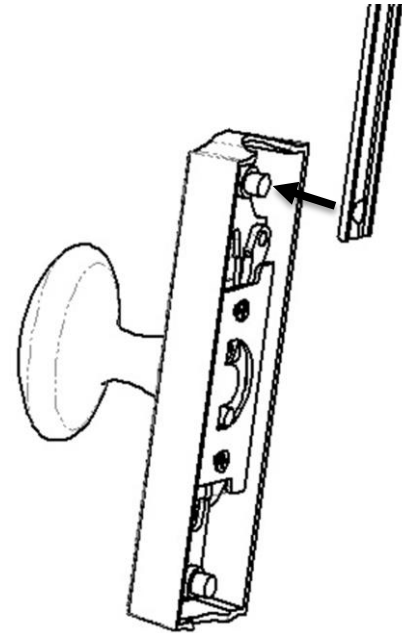

4. Once you have done this fix the centre module to the selected position on your door using the 38mm long screws but do not drive screws fully as you need to be able to connect the bolts to the back of the mechanism.

ES34/35 Espagnolette Bolt Fitting Instructions

5. Maneuverer the one of the bolts into the either of oval shaped holes in the centre module with the flat side to the door face, and connect the 6.25mm hole in the bolt to the pin on the back of the centre module mechanism.
6. Repeat this procedure for the opposite side and then finally screw in the centre module fully, making sure that the bolts are the correct lengths. If not, make adjustments as necessary before continuing.
7. There are four types of saddles supplied with this product, some of them are fitted with a nylon insert to help stop scratching to the bolts when in operation, the position of these saddles is your decision but we would suggest that one is fixed near to the outer end of each bolt. Fix all four saddles in position with the 30mm screws provided.
Note. One saddle has a hexagon set screw in the centre, this will enable you to lock the bolts into the 'shot' or 'un-shot' position should you so desire, using the hexagon 'Allen' key provided. Make sure your bolts are vertically straight before fitting the saddles and also remember the possible necessity for the shims as referred to in note 3.

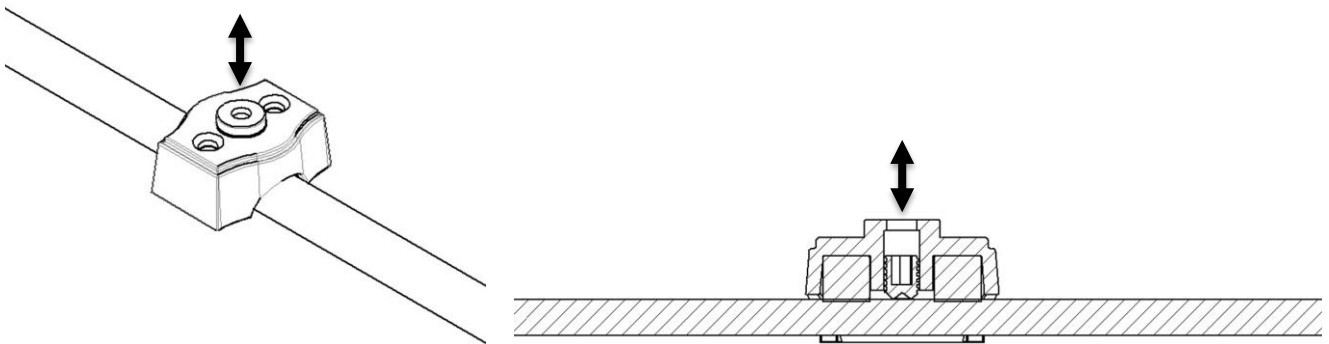

8. Now fit whatever keeps are best suited to your joinery but some adjustment to your joinery may be necessary at this point.