



ES400-404

AIR TRANSFER VENT

Dimensions (mm):

- ES400 150x150
- ES401 150x300
- ES402 300x300
- ES403 112x225
- ES404 225x225



ES420-424

FACE PLATE COVER FOR AIR TRANSFER VENT

Dimensions (mm):

- ES420 To match ES400 150x150
- ES421 To match ES401 150x300
- ES422 To match ES402 300x300
- ES423 To match ES403 112x225
- ES424 To match ES404 225x225

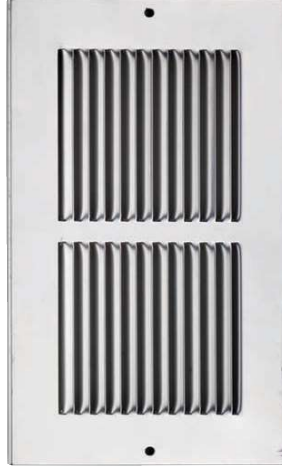

CYLINDERS MP5 STANDARD SECURITY
EURO SINGLE CYLINDER

Dimensions (mm):

CYE71140 40-30/10
CYE71145 45-35/10



EURO DOUBLE CYLINDER

Dimensions (mm):

CYE71260 60-30/30
CYE71270 70-35/35
CYE71280 80-40/40
CYE71290 90-45/45
CYE712100 100-50/50

Offset Variations:

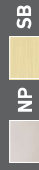
CYE7123035 65-30/35
CYE7123040 70-30/40
CYE7123050 80-30/50
CYE7123540 75-35/40
CYE7123545 80-35/45
CYE7123550 85-35/50
CYE7124045 85-40/45
CYE7124050 90-40/50
CYE7124055 95-40/55
CYE7124060 100-40/60
CYE7124550 95-45/50
CYE7124555 100-45/55

CYLINDERS MP5 STANDARD SECURITY
OVAL SINGLE CYLINDER

Dimensions (mm):

CYE72140 40-30/10
CYE72145 45-35/10

EURO CYLINDER AND TURN

Dimensions (mm):

CYE71360 60-30/30
CYE71370 70-35/35
CYE71380 80-40/40
CYE71390 90-45/45

Offset Variations: 1st dimension = key side

CYE7133040 70-30/40
CYE7133540 75-35/40
CYE7133555 90-35/55
CYE7134030 70-40/30
CYE7134035 75-40/35
CYE7134050 90-40/50
CYE7134060 100-40/60
CYE7134555 100-45/55
CYE7135040 90-50/40
CYE7135535 90-55/35
CYE7135545 100-55/45
CYE7136040 100-60/40





CYLINDERS MP5 STANDARD SECURITY

OVAL DOUBLE CYLINDER



Dimensions (mm):
CYE72260 60-30/30
CYE72270 70-35/35



OVAL CYLINDER AND TURN



Dimensions (mm):
CYE72360 60-30/30
CYE72370 70-35/35



STANDARD RIM CYLINDER



Dimensions (mm):
CYE73520 32 Dia.



CYLINDERS MP5 STANDARD SECURITY

CYLINDERS MP5 STANDARD SECURITY

CYLINDERS MP5 STANDARD SECURITY

EURO SINGLE CYLINDER



Dimensions (mm):	KA	UMK
CYA71140	40-30/10	CYB77140
CYA71145	45-35/10	CYB77145
CYA71150	50-40/10	CYB77150



EURO DOUBLE CYLINDER



Dimensions (mm):	KA	UMK
CYA71260	60-30/30	CYB77260
CYA71270	70-35/35	CYB77270
CYA71280	80-40/40	CYB77280
CYA71290	90-45/45	CYB77290
CYA712100	100-50/50	CYB772100
CYA712110	110-55/55	CYB772110

Offset Variations:

CYA7123040	70-30/40	CYB7723040
CYA7123050	80-30/50	CYB7723050
CYA7123540	75-35/40	CYB7723540
CYA7123545	80-35/45	CYB7723545
CYA7123550	85-35/50	CYB7723550
CYA7124050	90-40/50	CYB7724050
CYA7124060	100-40/60	CYB7724060
CYA7124550	95-45/50	CYB7724550



RIM CYLINDER & EURO CYLINDER/TURN



Dimensions (mm):	
CYA71370/73520	70-35/35



EURO CYLINDER & TURN (Pair)



Dimensions (mm):	
CYA71370/2	70-35/35



CYLINDERS MP5 STANDARD SECURITY

CYLINDERS MP5 STANDARD SECURITY

EURO CYLINDER & TURN



Dimensions (mm):	KA	UMK
CYA71360	60-30/30	CYB77360
CYA71370	70-35/35	CYB77370
CYA71380	80-40/40	CYB77380
CYA71390	90-45/45	CYB77390
CYA713100	100-50/50	CYB773100

Offset Variations: 1st dimension = key side

CYA713040	70-30/40	CYB773040
CYA7134030	70-40/30	CYB7734030
CYA7133545	80-35/45	CYB7733545
CYA7134535	80-45/35	CYB7734535
CYA7134060	100-40/60	CYB7734060
CYA7136040	100-60/40	CYB7736040



OVAL SINGLE CYLINDER



Dimensions (mm):	KA	UMK
CYA72140	40-30/10	CYB78140
CYA72145	45-35/10	CYB78145
CYA72150	50-40/10	CYB78150



OVAL DOUBLE CYLINDER



Dimensions (mm):	KA	UMK
CYA72260	60-30/30	CYB78260
CYA72270	70-35/35	CYB78270
CYA72280	80-40/40	CYB78280



OVAL CYLINDER AND TURN



Dimensions (mm):	KA	UMK
CYA72360	60-30/30	CYB78360
CYA72370	70-35/35	CYB78370
CYA72380	80-40/40	CYB78380



STANDARD RIM CYLINDER



Dimensions (mm): KA
CYA73520 32 Dia. CYB76520 UMK



THREADED RIM CYLINDER



Dimensions (mm): KA
CYA73620 32 Dia. CYB76620 UMK
CYA73620/2 32 Dia. (Pair)



OPEN SHACKLE PADLOCK



Dimensions (mm): KA
CYB7PLO47 47 CYB7PLO47KA CYB7PLO47UMK
Matching Cylinder:
CYA71130SC/O CYB74130/O CYB77130/O



CLOSED SHACKLE PADLOCK



Dimensions (mm): KA
CYH7PLC55 55 CYB7PLC55KA CYB7PLC55UMK
Matching Cylinder:
CYA71130SC/C CYB74130/C CYB77130/C





CYLINDERS MP5 STANDARD SECURITY

EURO BATHROOM CYLINDER & TURN



Dimensions (mm):
CYA70470 70-35/35



EURO SINGLE THUMBTURN ONLY



Dimensions (mm):
CYA70445 45-35/10



CYLINDERS MP5 STANDARD SECURITY

LEVER INSERT FOR EURO CYLINDER LOCK



Dimensions (mm):
AEIL5000 33



CYLINDERS MPx6 HIGH SECURITY

EURO SINGLE CYLINDER



Dimensions (mm):

KA	UMK
CYX71146 46-36/10	CYF77146
CYX71150 50-40/10	CYF77150

PB **PC** **SC**

EURO DOUBLE CYLINDER



Dimensions (mm):

KA	UMK
CYX71270 70-35/35	CYF77270
CYX71280 80-40/40	CYF77280
CYX71290 90-45/45	CYF77290
CYX712100 100-50/50	CYF772100
CYX712110 110-55/55	CYF772110

Offset Variations:

CYX7123540 75-35/40	CYF7423540
CYX7123545 80-35/45	CYF7423545
CYX7123550 85-35/50	CYF7423550
CYX7124050 90-40/50	CYF7424050
CYX7124060 100-40/60	CYF7424060
CYX7124550 95-45/50	CYF7424550

PB **PC** **SC**

CYLINDERS MPx6 HIGH SECURITY

EURO CYLINDER AND TURN



Dimensions (mm):

KA	UMK
CYX71370 70-35/35	CYF77370
CYX71380 80-40/40	CYF77380
CYX71390 90-45/45	CYF77390
CYX713100 100-50/50	CYF773100

Offset Variations: 1st dimension = key side

CYX7133545 80-35/45	CYF7433545
CYX7134060 100-40/60	CYF7434060
CYX7134535 80-45/35	CYF7434535
CYX7136040 100-60/40	CYF7436040

PB **PC** **SC**

STANDARD RIM CYLINDER



Dimensions (mm):

KA	UMK
CYF73524 32 Dia.	CYF79524

PB **PC** **SC**

CYLINDERS MPx6 HIGH SECURITY

THREADED RIM CYLINDER



Dimensions (mm): KA UMK
CYF73624 32 Dia. CYF76624 CYF79624



RESTRICTED CYLINDERS MP10 HIGH SECURITY

EURO SINGLE CYLINDER



Dimensions (mm): KA UMK
CYH71142 42-32/10 CYG74142 CYG77142
CYH71146 46-36/10 CYG74146 CYG77146
CYH71150 50-40/10 CYG74150 CYG77150



EURO DOUBLE CYLINDER



Dimensions (mm): KA UMK
CYH71264 64-32/32 CYG74264 CYG77264
CYH71270 70-35/35 CYG74270 CYG77270
CYH71280 80-40/40 CYG74280 CYG77280
CYH71290 90-45/45 CYG74290 CYG77290
CYH712100 100-50/50 CYG742100 CYG772100

Offset Variations:

CYH7123240 72-32/40 CYG7423240 CYG7723240
CYH7123250 82-32/50 CYG7423250 CYG7723250
CYH7123540 75-35/40 CYG7423540 CYG7723540
CYH7123545 80-35/45 CYG7423545 CYG7723545
CYH7123550 85-35/50 CYG7423550 CYG7723550
CYH7123555 90-35/55 CYG7423555 CYG7723555
CYH7124045 85-40/45 CYG7424045 CYG7724045
CYH7124050 90-40/50 CYG7424050 CYG7724050
CYH7124055 95-40/55 CYG7424055 CYG7724055
CYH7124060 100-40/60 CYG7424060 CYG7724060
CYH7124550 95-45/50 CYG7424550 CYG7724550
CYH7124555 100-45/55 CYG7424555 CYG7724555



RESTRICTED CYLINDERS MP10 HIGH SECURITY

EURO CYLINDER AND TURN



Dimensions (mm):	KA	UMK
CYH71364	64-32/32	CYG74364
CYH71370	70-35/35	CYG74370
CYH71380	80-40/40	CYG74380
CYH71390	90-45/45	CYG74390
CYH713100	100-50/50	CYG743100

Offset Variations: 1st dimension = key side

CYH7133240	72-32/40	CYG7433240	CYG7733240
CYH7133545	80-35/45	CYG7433545	CYG7733545
CYH7133555	90-35/55	CYG7433555	CYG7733555
CYH7134032	72-40/32	CYG7434032	CYG7734032
CYH7134050	90-40/50	CYG7434050	CYG7734050
CYH7134060	100-40/60	CYG7434060	CYG7734060
CYH7134535	80-45/35	CYG7434535	CYG7734535
CYH7134550	95-45/50	CYG7434550	CYG7734550
CYH7135040	90-50/40	CYG7435040	CYG7735040
CYH7135045	95-50/45	CYG7435045	CYG7735045
CYH7136040	100-60/40	CYG7436040	CYG7736040

CLASSROOM CYLINDERS



Dimensions (mm):	KA	UMK
CYH71370CR	70-35/35	CYG74370CR
CYH71380CR	80-40/40	CYG74380CR

Dimensions (mm):	KA	UMK
CYH71370CR	70-35/35	CYG77370CR
CYH71380CR	80-40/40	CYG77380CR

RESTRICTED CYLINDERS MP10 HIGH SECURITY

OVAL SINGLE CYLINDER



Dimensions (mm):	KA	UMK
CYH72142	42-32/10	CYG78142
CYH72146	46-36/10	CYG78146

Dimensions (mm):	KA	UMK
CYH72264	64-32/32	CYG75264
CYH72270	70-35/35	CYG75270
CYH72280	80-40/40	CYG75280

OVAL DOUBLE CYLINDER



Dimensions (mm):	KA	UMK
CYH72264	64-32/32	CYG75264
CYH72270	70-35/35	CYG75270
CYH72280	80-40/40	CYG75280

Dimensions (mm):	KA	UMK
CYH72264	64-32/32	CYG78264
CYH72270	70-35/35	CYG78270
CYH72280	80-40/40	CYG78280

RESTRICTED CYLINDERS MP10 HIGH SECURITY

OVAL DOUBLE CYLINDER AND TURN



Dimensions (mm): KA
 CYH72364 64-82/82 CYG75364 UMK
 CYH72370 70-85/85 CYG75370
 CYH72380 80-40/40 CYG75380



SCANDINAVIAN OVAL CYLINDER



Dimensions (mm): KA UMK
 CYH72-S031 31 CYG75-S031
 CYH72-SP31/31 31/31 CYG75-SP31/31



RESTRICTED CYLINDERS MP10 HIGH SECURITY

OPEN SHACKLE PADLOCK



Dimensions (mm): KA UMK
 CYH7PLO47 47 CYG7PLO47KA CYG7PLO47UMK
 Matching Cylinder: CYG74.130/0 CYG77130/0



CLOSED SHACKLE PADLOCK



Dimensions (mm): KA UMK
 CYH7PLC55 55 CYG7PLC55KA CYG7PLC55UMK
 Matching Cylinder: CYG74.130/C CYG77130/C



RESTRICTED CYLINDERS MP10 HIGH SECURITY

UNIVERSAL RIM CYLINDER



Dimensions (mm): KA CYH73525 UMK CYG79525
 32 Dia. CYG76525

PB **PC** **SC**

PATENTED CYLINDERS MP15 MAXIMUM SECURITY

EURO SINGLE CYLINDER



Dimensions (mm): KA UMK
 CYP71141 41-31/10 CYP74141 CYP77141
 CYP71145 45-35/10 CYP74145 CYP77145

PB **PC** **SC**

EURO DOUBLE CYLINDER



Dimensions (mm): KA UMK
 CYP71262 62-31/31 CYP74262 CYP77262
 CYP71270 70-35/35 CYP74270 CYP77270
 CYP71282 82-41/41 CYP74282 CYP77282

PB **PC** **SC**



PATENTED CYLINDERS MP15 MAXIMUM SECURITY

EURO CYLINDER AND TURN



Dimensions (mm):
KA UMK
 CYP71362 62-31/31 CYP74362 CYP77362
 CYP71370 70-35/35 CYP74370 CYP77370
 CYP71382 82-41/41 CYP74382 CYP77382



STANDARD RIM CYLINDER



Dimensions (mm): 32 Dia.
KA UMK
 CYP73526 CYP76526 CYP79526



CYLINDER ACCESSORIES

ALTERNATIVE THUMBURNS



CYZ70006



CYZ70008



CYZ70011



CYZ70007



CYZ70009



CYZ70012



CYZ70016

Dimensions (mm):

CYZ70006 24x26 Standard Thumbturn
CYZ70007 28x34 Large Thumbturn
CYZ70008 38x25 Round Thumbturn
CYZ70009 24x26 Large Thumbturn with Grip
CYZ70011 28x31 Tall Semi-Circular Thumbturn
CYZ70012 24x28 Peanut Shaped Thumbturn
CYZ70016 28x66 Shaped Disabled Thumbturn



ACCESSORIES



- CYZ73607** Cylinder ring for threaded cylinder 7mm
- CYZ73610** Cylinder ring for threaded cylinder 10mm
- CYZ70002** 19mm key ring
- CYZ70003** Key tag
- CYZ70004NP** M5x65mm fixing screw (Nickel Plate)
- CYZ70004EB** M5x65mm fixing screw (Electro Brass)
- CYZ70040** Fixing screw for rim cylinder
- CYZ75060** Tail for 5/6 Pin rim cylinder
- CYZ70050** Tail for 10 Pin rim cylinder
- CYZ70050** Steel backplate for standard rim cylinder

KEYS



5 Pin Keys and Key Blanks:

- CYZ70000** Stocksuite master key
- CYZ70001** 5 Pin key blank
- CYZ7000D** Additional cut key/differ key
- CYZ7000M** Master/sub master key

6 Pin Keys and Key Blanks:

- CYZ78001NS** 6 Pin key blank
- CYZ7800MNS** Additional differ key
- CYZ7800DMS** Master/sub master key

10 Pin Keys and Key Blanks:

- CYZ75000NS** Stocksuite master key
- CYZ7500CNS** Construction key
- CYZ7500DMS** Differ key
- CYZ500MNS** Workshop cut master/sub master key

15 Pin Keys and Key Blanks (Colour Coded):

- CYZ72001B** Master/sub master key - blue
- CYZ72001BK** Differ key - black
- CYZ72001R** Construction key - red
- CYZ72001G** Grand master key - green













ESE5025

CONTRACT EURO PROFILE
SASHLOCK

Dimensions (mm): 64
Variations:
ESE5030

EB
 NP











EDE5025

CONTRACT EURO PROFILE
DEADLOCK

Dimensions (mm): 64
Variations:
EDE5030

EB
 NP











OSE5025

CONTRACT OVAL PROFILE
SASHLOCK

Dimensions (mm): 64
Variations:
OSE5030

EB
 NP











ODE5025

CONTRACT OVAL PROFILE
DEADLOCK

Dimensions (mm): 64
Variations:
ODE5030

EB
 NP











BAE5025

CONTRACT BATHROOM LOCK

Dimensions (mm): 64
Variations:
BAE5025/R
BAE5030
BAE5030/R

BLACK
 EB
 NP





ULE5025



CONTRACT UPRIGHT LATCH

Dimensions (mm): 64
Variations:
ULE5025/R
ULE5030
ULE5030/R

EB
 NP







LDE5325

CONTRACT 3 LEVER DEADLOCK

Dimensions (mm): 64 76

Variations:
LDE5330



RDE8043

CONTRACT RIM DEADLOCK

Dimensions (mm): 102x76

Variations:
RLE8043 Rim Latch
RSE8053 140x76 Rim Lock
RSE8064 152x102 Rim Lock



LSE5225-5330

CONTRACT SASHLOCK

Variations:
LSE5225 2 Lever 64
LSE5225/R 2 Lever Radius 64
LSE5230 2 Lever 76
LSE5230/R 2 Lever Radius 76
LSE5325 3 Lever 64
LSE5325/R 3 Lever Radius 64
LSE5330 3 Lever 76
LSE5330/R 3 Lever Radius 76



DSB8225

CONTRACT DOOR SECURITY BOLT

Dimensions (mm): 60

Variations:
WSB8125 Radius 64



LSE5225/REB

CONTRACT 2 LEVER SASHLOCK REBATED

Dimensions (mm): 64



DSK8000B

DOOR SECURITY BOLT KEY

Dimensions (mm):
Length: 35 65

Variations:
DSK8000L



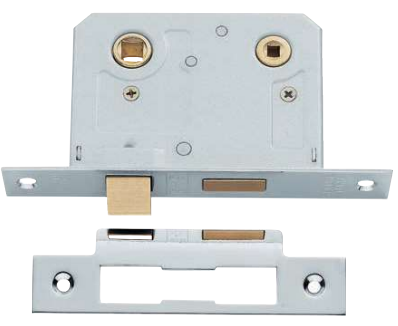







BL1-4

BATHROOM LOCK

Finish Variations:

BL1	EB/FB	64
BL3		76
BL2	NP	64
BL4		76

		
EB	FB	NP







BTL1-4

BOLT THROUGH TUBULAR LATCH

Finish Variations:

BTL1	EB	64
BTL3		76
BTL2	NP	64
BTL4		76

	
EB	NP









TL1-4

TUBULAR LATCH

Finish Variations:EB/FB/PCB

TL1	64
TL3	76
TL2	NP
TL4	64
	76

			
EB	FB	NP	PCB

CONTRACT LOCKS



RCB8260

CONTRACT RIM CYLINDER ROLLERBOLT

Dimensions (mm): 60

Variations: RCB8260L Lockcase Only

EB PC SC



RCN8240

CONTRACT RIM CYLINDER NIGHTLATCH

Dimensions (mm): 40

Variations: RCN8240L Lockcase Only

EB PC SC



RCN8260

CONTRACT RIM CYLINDER NIGHTLATCH

Dimensions (mm): 60

Variations: RCN8260L Lockcase Only

EB PC SC

CONTRACT LOCKS



RCN8160

TRADITIONAL RIM CYLINDER NIGHTLATCH

Dimensions (mm): 60

EB GN



RCN8340

DEADLOCKING RIM CYLINDER NIGHTLATCH

Dimensions (mm): 40

Variations: RCN8340L Lockcase Only

EB PC SC



RCN8360

DEADLOCKING RIM CYLINDER NIGHTLATCH

Dimensions (mm): 60

Variations: RCN8360L Lockcase Only

EB PC SC

EASI-T CONTRACT DIN LOCKS

DLE0055L

CONTRACT DIN LATCH

Dimensions (mm): 55
Variations: DLE0055L/R
Radius



DLE0055EP

CONTRACT DIN EURO PROFILE DEADLOCK

Dimensions (mm): 55
Variations: DLE0055EP/R
Radius



DLE7255EP

CONTRACT DIN EURO PROFILE SASHLOCK

Dimensions (mm): 55
Centres: 72
Variations: DLE7255EP/R
Radius



EASI-T CONTRACT DIN LOCKS

DLE7255NL

CONTRACT DIN EURO PROFILE NIGHTLATCH

Dimensions (mm): 55
Centres: 72
Variations: DLE7255NL/R
Radius



DLE7855WC

CONTRACT DIN BATHROOM LOCK

Dimensions (mm): 78
Centres: Follower 5 - 55
Variations: DLE7855WC/R
DLE7855WC/8
Radius
Follower 8



<p>LDS5325-5530</p> <p>DEADLOCK</p> <p>Variations: LDS5325 3 Lever 64 LDS5330 3 Lever 76 LDS5525 5 Lever 64 LDS5530 5 Lever 76</p> <p></p>						

<p>LSS5325-5530</p> <p>SASHLOCK</p> <p>Variations: LSS5325 3 Lever 64 LSS5330 3 Lever 76 LSS5525 5 Lever 64 LSS5530 5 Lever 76</p> <p></p>						

<p>RSL5030</p> <p>ROLLER BOLT EURO PROFILE DEADLOCK</p> <p>Dimensions (mm): 76</p> <p></p>						

EUROSPEC

LDS5325-30 13mm ARD5205 and 25mm ARD5210 rebate kits available in PVD and SSS finish.
 LSS5325-30 13mm ARS5105 and 25mm ARS5110 rebate kits available in PVD and SSS finish.
 RSL5030 13mm ARR5105 rebate kit available in SSS finish.
 Radius forend and strike pack available. Contact our sales office on 01228 511030 for details.

<p>EDS5025</p> <p>EURO PROFILE DEADLOCK</p> <p>Dimensions (mm): 64</p> <p>Variations: EDS5030 76</p> <p></p>						

<p>ESS5025</p> <p>EURO PROFILE SASHLOCK</p> <p>Dimensions (mm): 64</p> <p>Variations: ESS5030 76</p> <p></p>						

<p>ODS5025</p> <p>OVAL PROFILE CYLINDER DEADLOCK</p> <p>Dimensions (mm): 64</p> <p>Variations: ODS5030 76</p> <p></p>						

EUROSPEC

EDS5025-30 13mm ARD5005 and 25mm ARD5210 rebate kits available in PVD and SSS finish.
 ESS5025-30 13mm ARS5105 and 25mm ARS5110 rebate kits available in PVD and SSS finish.
 ODS5025-30 13mm ARD5205 and 25mm ARD5210 rebate kits available in PVD and SSS finish.
 Radius forend and strike pack available. Contact our sales office on 01228 511030 for details.

EASI-T ARCHITECTURAL LOCKS

--	--	--	--	--	--

OSS5025

OVAL PROFILE CYLINDER SASHLOCK

Dimensions (mm): 64
 Variations: OSS5030

--	--	--	--	--	--

BAS5025

BATHROOM LOCK

Dimensions (mm):
 Follower 5 - 64

Variations:
 BAS5030 Follower 5 - 76

--	--	--	--	--	--

MCN5025

EURO PROFILE CYLINDER NIGHTLATCH - CASE ONLY

Dimensions (mm): 64
 Variations: MCN5030

OSS5025-30, 13mm ARS5105 and 25mm ARS5110 rebate kits available in PVD and SSS finish.
 BAS5025, 13mm ARS5105 and 25mm ARS5110 rebate kits available in PVD and SSS finish.
 MCN5025-30, 13mm ARS5005 rebate kit available in SSS finish.
 Radius forend and strike pack available. Contact our sales office on 01228 511030 for details.

EASI-T ARCHITECTURAL LOCKS

--	--	--	--	--	--

FLD8025

FLAT DEADLOCK

Dimensions (mm): 64
 Variations: FLD8030
 FLD8040

--	--	--	--	--	--

FLL8025

FLAT LATCH

Dimensions (mm): 64
 Variations: FLL8030
 FLL8040

--	--	--	--	--	--

FLL5025

FLAT LATCH

Dimensions (mm): 64
 Variations: FLL5030
 FLL5040

FLL5025-40 13mm ARS105 rebate kit available in EB and SCP finish.
 FLL5025-40 13mm ARS5005 rebate kit available in EB and SCP finish.
 Radius forend and strike pack available. Contact our sales office on 01228 511030 for details.
 FLL5040 not available in EB finish. FLD8025-40 and FLL8025-40 do not have Easi-T facility.

EASI-T ARCHITECTURAL LOCKS

LCP1000

**EURO SECURITY CYLINDER
PULL WITH MINI LEVER**

Dimensions (mm): 94x52

PC SAA
PVD SC

FLE8030

MORTICE BOX LATCH

Dimensions (mm):
Backset: 76 63

NP

ULS5025

UPRIGHT LATCH

Dimensions (mm): 64 76

Variations:
ULS5030

PVD SSS

EASI-T ARCHITECTURAL LOCKS

DLD5030-50

TUBULAR DEAD BOLT

Variations:
DLD5030 Follower 8 - 76
DLD5040 Follower 8 - 102
DLD5050 Follower 8 - 127

FB PB SS

TLD5030-5850

TUBULAR DEAD BOLT

Variations:
TLD5030 Follower 5 - 76
TLD5040 Follower 5 - 102
TLD5050 Follower 5 - 127
TLD5830 Follower 8 - 76
TLD5840 Follower 8 - 102
TLD5850 Follower 8 - 127

EB SSS

DL5025-50

**HEAVY SPRUNG
TUBULAR LATCH**

Variations:
DL5025 Follower 8 - 64
DL5030 Follower 8 - 76
DL5040 Follower 8 - 102
DL5050 Follower 8 - 127

FB PB SS

	<p>TLS8030</p> <p>HEAVY SPRUNG TUBULAR LATCH</p> <p>Dimensions (mm): Follower 8 - 76</p> <p> <input type="checkbox"/> EB <input type="checkbox"/> NP <input type="checkbox"/> SC </p>

	<p>TLM503045/57</p> <p>MAGNETIC TUBULAR LATCH</p> <p>Variations: Backset 45 Backset 57</p> <p> <input type="checkbox"/> BSS <input type="checkbox"/> PVD <input type="checkbox"/> SSS <input type="checkbox"/> FB </p>

	<p>URLS5325-5530</p> <p>UNIVERSAL REPLACEMENT SASHLOCK</p> <p>Variations: 3 Lever 64 3 Lever 76 5 Lever 64 5 Lever 76</p> <p> <input type="checkbox"/> PVD <input type="checkbox"/> SSS </p>

	<p>URES5025-30</p> <p>UNIVERSAL REPLACEMENT EURO PROFILE SASHLOCK</p> <p>Variations: URES5025 URES5030</p> <p> <input type="checkbox"/> PVD <input type="checkbox"/> SSS </p>

	<p>URO5025-30</p> <p>UNIVERSAL REPLACEMENT OVAL PROFILE SASHLOCK</p> <p>Variations: URO5025 URO5030</p> <p> <input type="checkbox"/> PVD <input type="checkbox"/> SSS </p>

	<p>URBS5025-30</p> <p>UNIVERSAL REPLACEMENT BATHROOM SASHLOCK</p> <p>Variations: URBS5025 URBS5030</p> <p> <input type="checkbox"/> PVD <input type="checkbox"/> SSS </p>

DLS0060EP																			
DIN EURO PROFILE DEADLOCK																			
Dimensions (mm): 60																			
Variations: DLS0060EPSSS/R																			

DLS0060L																			
DIN LATCH																			
Dimensions (mm): 60																			
Variations: DLS0060LSSS/R																			

DLS7260EP																			
DIN EURO PROFILE SASHLOCK																			
Dimensions (mm): 60																			
Centres: 72																			
Variations: DLS7260EPSSS/R																			

EUROSPEC

DLS0060EP 13mm ARDS5005 rebate kit available in SSS finish. DLS0060L 13mm ARDS5005 rebate kit available in SSS finish. DLS7260EP 13mm ARDS5005 rebate kit available in SSS finish. DLS0060L and DLS7260EP also available in BSS and PVD finish using strike plate and forend kit. ASS5100 100mm split spindle with lock back feature available. ALP5038 1/2 set fixing plate also available. Contact our sales office on 01228 511030 for details.

DLS7260NLA																			
DIN EURO PROFILE NIGHTLATCH Anti-Thrust Strib																			
Dimensions (mm): 60																			
Centres: 72																			
Variations: DLS7260NLA5SS/R																			

DLS7860WC																			
DIN BATHROOM LOCK																			
Dimensions (mm): 60																			
Centres: 78																			
Variations: DLS7860WCSSS/R																			
Radius DLS7860WC/8/SSSFollower 8																			

DLS7260ESC																			
DIN EURO PROFILE ESCAPE LOCK																			
Dimensions (mm): 60																			
Centres: 72																			
Variations: DLS7260ESCSSS/R																			

EUROSPEC

DLS7260NLA 13mm ARDS5005 rebate kit available in SSS finish. DLS7860WC 13mm ARDS5005 rebate kit available in SSS finish. DLS7260NLA, DLS7860WC and DLS7260ESC 13mm ARDS5005 rebate kit available in SSS finish. ASS5100 100mm split spindle with lock back feature available. ALP5038 1/2 set fixing plate also available. Contact our sales office on 01228 511030 for details.

EASI-T BRITISH STANDARD LOCKS

LDB5525	5 LEVER BS DEADLOCK						
Dimensions (mm): 64							
Variations: 76							
LDB5530							

LSB5525	5 LEVER BS SASHLOCK						
Dimensions (mm): 64							
Variations: 76							
LSB5530							

EDB5025	EURO PROFILE BS CYLINDER DEADLOCK - COMPLETE SET						
Dimensions (mm): 64							
Variations: 76							
EDB5030							

LDB5525-30 13mm ARB5205 and 25mm ARB5210 rebate kits available in PVD and SSS finish. LSB5525-30 13mm ARB5105 and 25mm ARB5110 rebate kits available in PVD and SSS finish. EDB5025-30 13mm ARB5405 and 25mm ARB5410 rebate kits available in PVD and SSS finish. LSS5325-30 13mm ARB5105 and 25mm ARB5110 rebate kits available in PVD and SSS finish. Radius forend and strike pack available. LDB and LSB BS locks florentine bronze accessory packs available. Contact our sales office on 01228 511030 for details.

EASI-T BRITISH STANDARD LOCKS

ESB5025	EURO PROFILE BS CYLINDER SASHLOCK - COMPLETE SET						
Dimensions (mm): 64							
Variations: 76							
ESB5030							

EDB5025/CT	EURO PROFILE BS CYLINDER & TURN DEADLOCK - COMPLETE SET						
Dimensions (mm): 64							
Variations: 76							
EDB5030/CT							

ESB5025/CT	EURO PROFILE BS CYLINDER & TURN SASHLOCK - COMPLETE SET						
Dimensions (mm): 64							
Variations: 76							
ESB5030/CT							

ESB5025 13mm ARB5305 and 25mm ARB5310 rebate kits available in PVD and SSS finish. EDB5025-30CT 13mm ARB5405 and 25mm ARB5410 rebate kits available in PVD and SSS finish. ESB5025-30CT 13mm ARB5305 and 25mm ARB5310 rebate kits available in PVD and SSS finish. Radius forend and strike pack available. Contact our sales office on 01228 511030 for details.



LFB2

FIRE BRIGADE LOCK

Dimensions (mm): 51

Fire Brigade Lock Key:
AKSFB2



SSS



CL155SGVCB

**MECHANICAL DIGITAL
DOOR LOCK**

Dimensions (mm): 60
Latch:



SV



WINDOW FITTINGS



SZS73

CASEMENT FASTENER
Not Suitable for Weather Stripped Windows

Dimensions (mm): 120

CP PB
SC SN

WINDOW FITTINGS

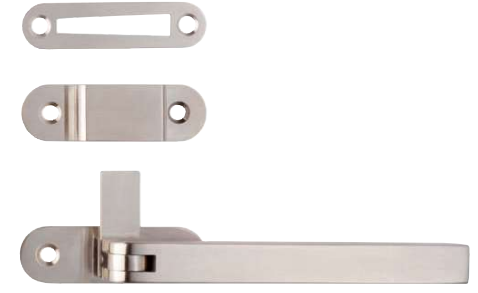

WF30

SQUARE CASEMENT FASTENER
Complete with Hook Plate and Flat Keep
Suitable for Weather Stripped Windows

Dimensions (mm): 125

SS

WINDOW FITTINGS



SZS44S

CASEMENT FASTENER

Dimensions (mm): 254

Variations: 203 305
SZS44C
SZS44B

CP SC SN



WF32

SQUARE CASEMENT STAY

Dimensions (mm): 253

SS



WF35

SQUARE LOCKING ESPAG FASTENER

Dimensions (mm): 125
Length:

SS

10

10



WF22S

ROUND CASEMENT STAY

Dimensions (mm): 253
Length:

Variations:
WF23
WF24

SS

10

10



WF21

ROUND CASEMENT FASTENER

Complete with Hook Plate and Flat Keep
Suitable for Weather Stripped Windows

Dimensions (mm): 125
Length:

SS

10

10



WF25

ROUND LOCKING ESPAG FASTENER

Dimensions (mm): 125
Length:

SS

10

10

WINDOW FITTINGS

WF12S

BULB END CASEMENT STAY
 Dimensions (mm): 254
 Length: 202
 Variations: 305

WF12C
 WF12B

CP FB SC
 DB PB SN



M44S

VICTORIAN CASEMENT STAY
 Dimensions (mm): 254
 Length: 202
 Variations: 305

M44C
 M44B

CP PB SN
 DB SC



AA73

SCREW DOWN PATTERN CASEMENT STAY
 Dimensions (mm): 254
 Length:

PB





WF12B not available in FB and SN finish. WF12C not available in DB, FB and SN finish. M44B not available in SN finish. M44C not available in DB or SN finish. For matching casement fasteners see P416.

WINDOW FITTINGS

DK7

QUADRANT ARM STAY
 Dimensions (mm): 150
 Length:

CP PB SC



DK8

ROLLER ARM STAY
 Dimensions (mm): 150
 Length:

CP PB SC



AA96

SASH HANDLE
 Dimensions (mm): 102
 Length:
 Variations: AA97

CP PB SC



WINDOW FITTINGS

WF14

PIN FOR FLUSH FITTING CASEMENT

Dimensions (mm): 42x39

Overall:

CP PB SC



WF15

EJMA PIN
9° Bevel for EJMA Windows

Dimensions (mm): 40x15
Plate: 27°
Height:

CP PB SC



WF17

LOCKING CASEMENT STAY PIN

Dimensions (mm): 40x15
Plate: 35
Height:

CP PB SC
FB PCB



WINDOW FITTINGS

V1006LCK

LOCKING CASEMENT FASTENER
Wedge Pattern Locking
Suitable for Weather Stripped Windows

Dimensions (mm): 13x67

Overall:

CP PB SC



V1008LH/RH

CRANKED LOCKING ESPAG HANDLE
V1008LH - Left hand
V1008RH - Right Hand
Suitable for Weather Stripped Windows

Dimensions (mm): 110

Length:

CP PB SC
FB







WF11

BULB END CASEMENT FASTENER
Both Hook and Mortice Plate Suitable for Weather Stripped Windows

Dimensions (mm): 98
Length:

Variations: Mortice Plate only
WF16 Suitable for Weather Stripped Windows



V1005

CASEMENT FASTENER
Wedge Pattern Suitable for Weather Stripped Windows

Dimensions (mm): 57x13
Backplate:

Variations:
V1005LCK Locking Casement Fastener 57x13



V1007LCK

VICTORIAN LOCKING CASEMENT FASTENER WITH NIGHT VENT
Suitable for Weather Stripped Windows

Dimensions (mm): 16x60
Backplate:

--	--	--

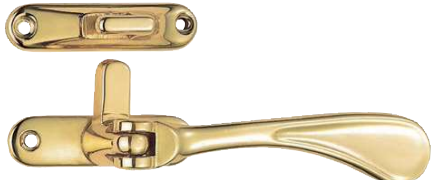

M73

CASEMENT FASTENER REVERSIBLE
Reversible Pattern Both Hook and Mortice Plate Not Suitable for Weather Stripped Windows

Dimensions (mm): 57x13
Backplate:

WINDOW FITTINGS



AA40

FITCH PATTERN SASH FASTENER

Dimensions (mm): 64x25

Overall:

Variations:
AA40LCK Locking Fitch Pattern Sash Fastener

CP PB SC



AQ39

ARCHITECTURAL QUALITY QUADRANT SASH FASTENER

Dimensions (mm): 70x20

Overall:

CP PB SC SN

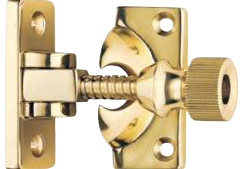

AQ43

ARCHITECTURAL QUALITY BRIGHTON SASH FASTENER

Dimensions (mm): 57x20

Overall:

CP PB SC SN

WINDOW FITTINGS



AA39

QUADRANT ARM SASH FASTENER

Dimensions (mm): 70x20

Overall:

PB

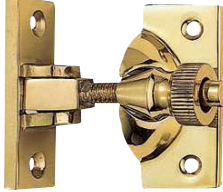

AA41

BRIGHTON PATTERN SASH FASTENER

Dimensions (mm): 57x20

Overall:

PB



DK42

FAN LIGHT CATCH

Dimensions (mm): 45x45

Overall:

CP PB SC

A042

GROOVED SASH LIFT

Dimensions (mm):
Overall: 52x48

CP PB
SC SN



AA42

SASH LIFT

Dimensions (mm):
Overall: 50x45

CP PB SC



AA42RI

RING SASH LIFT

Dimensions (mm):
Overall: 46x37

Variations:
AA42R Horizontal Fix: 44x34

CP PB SC



A050

SASH WINDOW LIFT

Dimensions (mm):
Overall: 63x24

CP PB
SC SN



A091

SASH WINDOW AXLE PULLEY

Galv Forend with Nylon Wheel

Dimensions (mm):
Forend: 117x25
Body: 76x39
Pulley: 42 Outer Dia.
Wheel Thickness: 10

GALV





AQ92



SASH WINDOW AXLE PULLEY
Square Forend with Nylon Wheel

Dimensions (mm):

Forend: 117x25
Body: 76x39
Pulley: 42 Outer Dia.
Wheel Thickness: 10

Variations:

AQ96

Heavy Duty Radius Forend with Brass Wheel

Dimensions (mm):

Forend: 127x28
Body: 83x52
Pulley: 50 Outer Dia.
Wheel Thickness: 13



AQ93



SASH WINDOW AXLE PULLEY
Square Forend with Brass Wheel

Dimensions (mm):

Forend: 117x25
Body: 76x39
Pulley: 42 Outer Dia.
Wheel Thickness: 10



LX21



SINGLE TOWEL RAIL

Dimensions (mm):
 Width: 450
 Height: 52
 Projection: 85

Variations:
LX22 Width: 650
LX23 Width: 850

BSS SS



Icons:   



LX25

GLASS SHELF

Dimensions (mm):
 Width: 650
 Height: 52
 Projection: 127

BSS SS



Icons:   

LX04



PULL HANDLE / GRAB RAIL

Dimensions (mm):
 Width: 500
 Height: 52
 Projection: 100

Variations:
LX04-600 Width: 600

BSS SS



Icons:   

LX07



PAPER HOLDER

Dimensions (mm):
 Width: 156
 Height: 52
 Projection: 90

Variations:
LX09 Hand Towel Holder Width: 237

BSS SS



Icons:   



LX12

SINGLE TUMBLER HOLDER

Dimensions (mm):
 Width: 63
 Height: 142
 Projection: 92

BSS SS



Icons:   



LX13

SOAP DISH

Dimensions (mm):
 Width: 112
 Height: 62
 Projection: 126

BSS SS



LX05

TOWEL RING

Dimensions (mm):
 Width: 301
 Height: 301
 Projection: 90

BSS SS



LX05

TOWEL RING

Dimensions (mm):
 Width: 301
 Height: 301
 Projection: 90

BSS SS



LX03

ROBE HOOK

Dimensions (mm):
 Width: 50
 Height: 53
 Projection: 44

BSS SS



LX14

TOILET BRUSH AND HOLDER

Dimensions (mm):
 Width: 78
 Height: 415
 Projection: 108

BSS SS



LX03

ROBE HOOK

Dimensions (mm):
 Width: 50
 Height: 53
 Projection: 44

BSS SS



LX03

ROBE HOOK

Dimensions (mm):
 Width: 50
 Height: 53
 Projection: 44

BSS SS



LX03

ROBE HOOK

Dimensions (mm):
 Width: 50
 Height: 53
 Projection: 44

BSS SS

LW18



DOUBLE TOWEL RAIL

Dimensions (mm):
 Width: 525
 Height: 115
 Projection: 122

Variations:
LW19 Width: 675
LW20 Width: 825

CP



Icons:   

LW21



SINGLE TOWEL RAIL

Dimensions (mm):
 Width: 525
 Height: 78
 Projection: 90

Variations:
LW22 Width: 675
LW23 Width: 825

CP



Icons:   

LW24



GLASS SHELF

Dimensions (mm):
 Width: 520
 Height: 50
 Projection: 100

Variations:
LW25 Width: 670
LW26 Width: 825

CP



Icons:   



LW05

TOWEL RING

Dimensions (mm):
 Width: 182
 Height: 240
 Projection: 92

CP



Icons:   



LW07

PAPER HOLDER

Dimensions (mm):
 Width: 177
 Height: 123
 Projection: 50

CP



Icons:   



LW12

SINGLE TUMBLER HOLDER

Dimensions (mm):
 Width: 77
 Height: 100
 Projection: 150



LW14

TOILET BRUSH AND HOLDER

Dimensions (mm):
 Width: 116
 Height: 380
 Projection: 182



LW13

SOAP DISH AND HOLDER

Dimensions (mm):
 Width: 112
 Height: 82
 Projection: 167



LW17

TRIANGULAR SOAP TRAY

Dimensions (mm):
 Width: 220
 Height: 66
 Projection: 220





LW02

DOUBLE ROBE HOOK

Dimensions (mm):
 Width: 59
 Height: 62
 Projection: 58

CP







LW09

TOOTHBRUSH HOLDER

Dimensions (mm):
 Width: 77
 Height: 72
 Projection: 151

CP







LW08

SPARE PAPER HOLDER

Dimensions (mm):
 Width: 76
 Height: 160
 Projection: 93

CP







LW27

LIQUID SOAP DISPENSER

Dimensions (mm):
 Width: 77
 Height: 166
 Projection: 150

CP





LW29





OVAL MIRROR

Dimensions (mm):
 Width: 400
 Height: 498
 Projection: 18

CP



LE18





DOUBLE TOWEL RAIL

Dimensions (mm):
 Width: 525
 Height: 123
 Projection: 102

Variations:
LE19 Width: 665
LE20 Width: 820

CP

LE21





SINGLE TOWEL RAIL

Dimensions (mm):
 Width: 465
 Height: 87
 Projection: 106

Variations:
LE22 Width: 670
LE23 Width: 820

CP

LE24





GLASS SHELF

Dimensions (mm):
 Width: 460
 Height: 52
 Projection: 123

Variations:
LE25 Width: 610
LE26 Width: 760

CP

LE28









OVERHEAD TOWEL RACK

Dimensions (mm):
 Width: 582
 Height: 168
 Projection: 299

CP

LE30









GALLERY RAIL GLASS SHELF

Dimensions (mm):
 Width: 559
 Height: 59
 Projection: 163

CP

LE04

GRAB RAIL

Dimensions (mm):
 Width: 513
 Height: 70
 Projection: 63

CP



LE02

DOUBLE ROBE HOOK

Dimensions (mm):
Width: 79
Height: 52
Projection: 70

CP



LE03

SINGLE ROBE HOOK

Dimensions (mm):
Width: 52
Height: 52
Projection: 55

CP



LE05

TOWEL RING

Dimensions (mm):
Width: 169
Height: 195
Projection: 65

CP



LE07

PAPER HOLDER

Dimensions (mm):
Width: 182
Height: 119
Projection: 64

CP

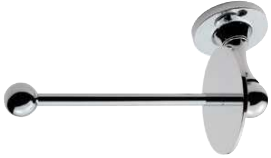

LE08

SPARE PAPER HOLDER

Dimensions (mm):
Width: 70
Height: 190
Projection: 98

CP



LE11

DOUBLE TUMBLER HOLDER

Dimensions (mm):
Width: 167
Height: 97
Projection: 150

CP

	LE12
SINGLE TUMBLER HOLDER	
Dimensions (mm):	
Width:	73
Height:	98
Projection:	125
<input type="checkbox"/> CP	

	LE13
SOAP DISH AND HOLDER	
Dimensions (mm):	
Width:	157
Height:	53
Projection:	166
<input type="checkbox"/> CP	

	LE09
TOOTHBRUSH HOLDER	
Dimensions (mm):	
Width:	107
Height:	107
Projection:	87
<input type="checkbox"/> CP	

LE12 spare tumblers LE11C available. LE13 spare soap dishes LE13C available. LE09 spare toothbrush pots LE09C available. Contact our sales office on 01228 511030 for details.

	LE06
PILLAR PAPER HOLDER	
Dimensions (mm):	
Width:	210
Height:	52
Projection:	80
<input type="checkbox"/> CP	

	LE31
DOG BONE PAPER HOLDER	
Dimensions (mm):	
Width:	208
Height:	53
Projection:	78
<input type="checkbox"/> CP	

	LE16
SHOWER SOAP DISH	
Dimensions (mm):	
Width:	192
Height:	63
Projection:	128
<input type="checkbox"/> CP	



LE17

TRIANGULAR TRAY

Dimensions (mm):
 Width: 226
 Height: 68
 Projection: 226

CP

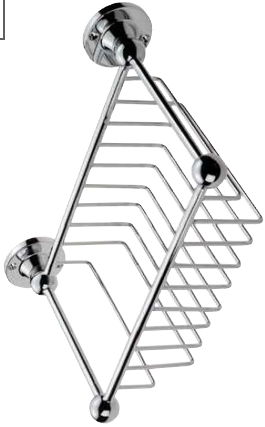

LE15

SPONGE HOLDER

Dimensions (mm):
 Width: 277
 Height: 88
 Projection: 178

CP



LE14

TOILET BRUSH AND HOLDER

Dimensions (mm):
 Width: 115
 Height: 415
 Projection: 154

CP



LV19

DOUBLE TOWEL RAIL

Dimensions (mm):
 Width: 600
 Height: 47
 Projection: 118

CP



LV22

SINGLE TOWEL RAIL

Dimensions (mm):
 Width: 600
 Height: 47
 Projection: 70

CP



LV24

GLASS SHELF

Dimensions (mm):
 Width: 520
 Height: 97
 Projection: 126

CP





LV02

ROBE HOOK

Dimensions (mm):
 Width: 47
 Height: 70
 Projection: 70

CP









LV05

TOWEL BAR

Dimensions (mm):
 Width: 218
 Height: 54
 Projection: 70

CP











LV07

PAPER HOLDER

Dimensions (mm):
 Width: 175
 Height: 47
 Projection: 70

CP











LV12

SINGLE TUMBLER HOLDER

Dimensions (mm):
 Width: 127
 Height: 95
 Projection: 98

CP











LV11

DOUBLE TUMBLER HOLDER

Dimensions (mm):
 Width: 175
 Height: 95
 Projection: 98

CP







LV13

SOAP DISH AND HOLDER

Dimensions (mm):

Width:	149
Height:	50
Projection:	118

CP

LV14

TOILET BRUSH AND HOLDER

Dimensions (mm):

Width:	165
Height:	370
Projection:	122

CP

FINGERTIP



FTD685

BAR HANDLE

CODE	CP	SN	M4	T
FTD685C	160	180	41	25
FTD685D	192	212	41	25
FTD685E	224	244	41	25

CP MSC CPSN



FTD4215

ARIA HANDLE

CODE	CP	SN	M4	T
FTD4215C	160	200	27	25
FTD4215E	224	264	27	25
FTD4215G	320	360	27	25
FTD4215J	448	488	27	25

CP MSC CPSN



FTD4220

OVENCO HANDLE

CODE	CP	SN	M4	T
FTD4220C	160	240	35	25
FTD4220D	192	272	35	25
FTD4220E	224	314	35	25
FTD4220G	320	410	35	25

CP SN

FINGERTIP



FTD4225

SOLANO HANDLE

CODE	CP	SN	M4	T
FTD4225C	160	172	36	25
FTD4225E	224	236	36	25
FTD4225G	320	332	36	25
FTD4225J	448	460	36	25

CP MSC CPSN



FTD3170

VALETTA BOW HANDLE

CODE	CP	SN	M4	T
FTD3170A	160	184	27	25
FTD3170B	192	219	27	25
FTD3170C	320	338	29	25

CP SN



FTD3180

FULCRUM D HANDLE

CODE	CP	SN	M4	T
FTD3180A	160	183	31	25
FTD3180B	320	343	31	25

CP SN



FTD3190

SARO BOW HANDLE

CODE	TT	TTI	M4
FTD3190A	160	182	26 25
FTD3190B	224	240	26 25

CP SN



FTD3065

SLIM D HANDLE

CODE	TT	TTI	M4
FTD3065A	128	163	25 25
FTD3065B	160	193	26 25
FTD3065C	192	225	26 25
FTD3060D	256	288	26 25

CP SN



FTD3550

SQUARE SECTION HANDLE

CODE	TT	TTI	M4
FTD3550B	128	143	37 25
FTD3550C	160	175	37 25
FTD3550D	192	207	37 25
FTD3550E	224	239	37 25
FTD3550F	320	335	37 25
FTD3550G	448	463	37 25

NB SN



FTD4750

BAR HANDLE

CODE	TT	TTI	M4
FTD4750B	128	168	36 25 & 62
FTD4750B	160	200	36 25 & 62
FTD4750B	192	232	36 25 & 62
FTD4750B	256	296	36 25 & 62
FTD4750B	320	360	36 25 & 62
FTD4750B	448	488	36 25 & 62
FTD4750B	608	648	36 25 & 62
FTD4750B	864	904	36 25 & 62

SNSS



FTD480

KEYHOLE HANDLE

CODE	TT	TTI	M4
FTD480B	160	184	43 25
FTD480E	256	280	43 25
FTD480H	352	376	43 25
FTD480J	448	472	43 25
FTD480K	608	632	43 25

SNSS



FTD470

KEYHOLE HANDLE

CODE	TT	TTI	M4
FTD470B	128	140	32 25
FTD470C	160	172	32 25
FTD470D	192	204	32 25
FTD470E	224	236	32 25
FTD470J	448	460	32 25
FTD470L	576	588	32 25

CPSN

FINGERTIP



FTD685

CLEAR ACRYLIC BAR HANDLE

CODE	TT	TT	TT	M4	T
FTD685A	96	116	41	25	25
FTD685B	128	148	41	25	25
FTD685C	160	180	41	25	25

ACC

FINGERTIP



FTD2065

TAPERED END HANDLE

CODE	TT	TT	TT	M4	T
FTD2065	160	202	32	25	25

CP **SN**



FTD2550

RECTANGULAR SECTION D HANDLE

CODE	TT	TT	TT	M4	T
FTD2550B	128	136	30	25	25
FTD2550C	160	168	30	25	25
FTD2550D	192	200	30	25	25
FTD2550E	224	232	30	25	25

SS



FTD3150

VENTURI D HANDLE

CODE	TT	TT	TT	M4	T
FTD3150A	128	146	34	62	62
FTD3150B	160	182	37	62	62

CP **SN**



FTD335

DUO HANDLE

CODE	TT	TT	TT	M4	T
FTD335B	128	152	34	62	62

CPMSC



FTD2030

ANGLED END BOW HANDLE

CODE	TT	TT	TT	M4	T
FTD2030A	128	167	30	25	25
FTD2030B	192	241	30	25	25

SN

FINGERTIP



AA100

CABINET D HANDLE

CODE				
AA100	96	104	31	62
AA101	96	104	31	62
AA102	152	160	31	62
AA103	152	160	31	62

CP PB



FTD460

D HANDLE

CODE			
FTD460A	96	106	30
FTD460B	128	138	30
FTD460C	160	170	30
FTD460D	192	202	30
FTD460E	224	234	30
FTD460F	288	298	30
FTD460G	320	330	30
FTD460H	352	362	30

CP



FTD3160

CURVA BOW HANDLE

CODE				
FTD3160A	160	170	24	25
FTD3160B	224	238	34	25

CP SN

FINGERTIP



FTD2040

CONCAVE BOW HANDLE

CODE				
FTD2040A	128	162	24	25
FTD2040B	160	202	30	25

CP SN



FTD3440

SOLO HANDLE

CODE				
FTD3440	128	154	26	25

SN





FTD520

SHAKER STYLE HANDLE

CODE					
FTD520	76	128	26	62	



CP SB SN



FTD2500



RECTANGULAR SECTION T-BAR HANDLE

CODE				M4	T
FTD2500A	128	197	30	25	25
FTD2500B	160	229	30	25	25
FTD2500C	192	260	30	25	25
FTD2500D	224	292	30	25	25



SS



FTD445



STEEL T-BAR HANDLE

CODE				M4	T
FTD445A	96	156	35	25	25
FTD445B	128	188	35	25	25
FTD445C	160	220	35	25	25
FTD445D	192	252	35	25	25
FTD445E	224	284	35	25	25
FTD445F	288	348	35	25	25
FTD445G	352	412	35	25	25
FTD445H	384	444	35	25	25
FTD445J	448	508	35	25	25
FTD445L	512	572	35	25	25
FTD445M	608	668	35	25	25
FTD445N	640	700	35	25	25
FTD445P	768	828	35	25	25
FTD445S	864	924	35	25	25
FTD445V	960	1020	35	25	25
FTD445W	1024	1084	35	25	25



CP SC SN



FTD605R



REEDED HANDLE

CODE				M4	T
FTD605R	128	151	39	62	62



NB SN



FTD410



STAINLESS STEEL T-BAR HANDLE

CODE				M4	T
FTD410A	96	156	30	25	25
FTD410B	128	188	30	25	25
FTD410C	160	220	30	25	25



SS



FTD200



CURVED HANDLE

CODE				M4	T
FTD200B	128	150	31	62	62



CP SC

FTD444



MINI T-BAR HANDLE

CODE				M4	T
FTD444	64	100	26	25	25

CP MSC SN

FINGERTIP



FTD250

CURVED HANDLE WITH OVAL FEET

CODE	128	141	27	25
FTD250B	128	141	27	25

SN

FINGERTIP



FTD2080

CHUNKY ARCHED GRIP HANDLE

CODE	128	155	32	25
FTD2080A	128	155	32	25
FTD2080B	160	195	41	25

SN



FTD2090

L SECTION PULL HANDLE

CODE	160	176	22	25
FTD2090B	160	176	22	25
FTD2090D	224	240	22	25

CP SN



FTD330

CRINKLE HANDLE

CODE	160	175	30	62
FTD330B	160	175	30	62

SN NB



FTD2095

LARGE INFINITY HANDLE

CODE	224	264	25	25
FTD2095E	224	264	25	25

CP SN



FTD2035

RADIUSED END FLAT BOW HANDLE



CODE	128	144	24	25
FTD2035A	128	144	24	25
FTD2035B	160	173	26	25

CP SN





FTD343

PLATYPUS BOW HANDLE

CODE  

FTD343	128	166	30	25
--------	-----	-----	----	----





FTD2060

SHOE TREE HANDLE

CODE 



FTD2060A	128	205	28	25
FTD2060B	160	235	32	25







FTD380

WAISTED FLAT BOW HANDLE

CODE  



FTD380A	96	140	23	25
FTD380B	128	182	25	25







FTD272

QUADRA BOW HANDLE

CODE  



FTD272B	127	161	30	25
---------	-----	-----	----	----







FTD280

WIRE PATTERN BOW HANDLE

CODE  



FTD280B	128	168	26	62
---------	-----	-----	----	----





FTD450

BOW HANDLE

CODE   

FTD450A	96	119	30	25
FTD450B	128	153	31	25
FTD450C	160	190	32	25
FTD450D	192	226	32	25
FTD450E	224	256	32	25
FTD450F	288	338	33	25
FTD450G	320	372	36	25
FTD450H	352	406	38	25

FINGERTIP



FTD420

STAINLESS STEEL BOW HANDLE

CODE	128	150	160	190	32	25
FTD420A	96	117	117	30	31	25
FTD420B	128	150	150	31	25	25
FTD420C	160	190	190	32	25	25

SS



FTD2010

WAISTED BOW HANDLE

CODE	128	142	288	28	33	25
FTD2010B	128	142	288	28	33	25
FTD2010E	224	288	288	33	25	25

CP MSC SN



FTD270

CURVED CONVEX GRIP HANDLE

CODE	128	146	28	62
FTD270A	128	146	28	62

SN

FINGERTIP



FTD2025

TWISTED BOW HANDLE

CODE	128	162	30	25
FTD2025B	128	162	30	25

SN



FTD2015

FLAT TOP BOW HANDLE

CODE	128	153	26	25
FTD2015B	128	153	26	25

SN



FTD205

WAVE PATTERN HANDLE

CODE	128	144	22	62
FTD205B	128	144	22	62

CP SC

FINGERTIP





FTD260

POINTED GRIP HANDLE

CODE    M4

FTD260B 128 166 33 62

 CP  SN

FINGERTIP



FTD350

ARCOVALE HANDLE

CODE    M4

FTD350A 64 98 24 62
FTD350B 128 164 27 62



 SN

FINGERTIP





FTD275

CIRCLE DESIGN CURVED HANDLE

CODE    M4



FTD275A 96 142 24 25
FTD275B 128 184 27 25

 CP  SN







FTD555

TRADITIONAL CUP HANDLE

CODE    M4

FTD555 64 104 25 62

 AB  ABB  PT
 SB  SN



FTD230

DIMPLE EFFECT CURVED HANDLE

CODE    M4



FTD230A 96 122 27 23
FTD230B 128 156 27 23

 CP  SN



FTD556

CUP HANDLE



CODE    M4

FTD556 64 86 25 25

 CP  SN



FINGERTIP











FTD2045

CONTEMPORARY CUP HANDLE

CODE				M4
FTD2045A	96	172	18	25
FTD2045B	128	201	18	25



MSC
 SN











CH84

WAVE BOW HANDLE

CODE				M4
CH84A	64	94	23	62
CH84B	96	146	25	62



CP
 SC



FTD565



SHAKER HANDLE

CODE				M4
FTD565	96	130	23	25

MSC
 SN



FINGERTIP



FTD377

TRUMPET KNOB

CODE				M4
FTD377	25	32	25	

SN







FTD3565

HELIO KNOB

CODE				M4
FTD3565	16	32x30	24	25

CP
 SN







FTD3570

ELIAS KNOB

CODE				M4
FTD3570	41x20	24	25	

CP
 SN

FINGERTIP





FTD4030

CRESCENT KNOB

CODE   M4

FTD4030 33x22 16 25

 CP  SN





FTD2095

SMALL INFINITY KNOB

CODE   M4

FTD2095A 32 55 25 25



 CP  SN







FTD4040

PINCH KNOB

CODE   M4

FTD4040 31x18 19 25

 CP  SN



FINGERTIP







FTD4045

MARIN KNOB

CODE   M4

FTD4045A 38x38 21 25

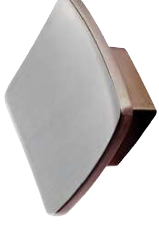

 CP  SN







FTD4020

NOVUS KNOB

CODE   M4

FTD4020A 16 44x44 18 25

 CP  SN







FTD4025

GAMMA KNOB

CODE   M4

FTD4025 32 48x48 23 25

 CP  SN



CH81

SHAPED CYLINDER KNOB

CODE Knob Rose
CH81 15 dia. 13 dia. 20 25

SN



M1003

QUEEN ANNE KNOB

CODE Knob Rose
M1003 23 dia. 25 dia. 33 25 & 62
M1004 28 dia. 30 dia. 41 25 & 62
M1005 35 dia. 38 dia. 51 25 & 62

CP **PB**
 FB **SC**



FTD2525

SQUARE KNOB

CODE D/A
FTD2525A 18x18 25 25
FTD2525B 22x22 30 25

CP **SN**



FTD600R

REEDED KNOB WITH FINIAL EARS

CODE
FTD600R 70x26 26 dia. 46 62

NB **SN**





FTD770

ROUND CRYSTAL KNOB

CODE	Knob	Rose	M4	T
FTD770C	34 dia.	18 dia.	36	25

CP MSN



FTD790

SQUARE CRYSTAL KNOB

CODE	Knob	Rose	M4	T
FTD790B	32 x 32 dia.	31 dia.	25	
FTD790C	38 x 38 dia.	37 dia.	25	

CP MSN



FTD670

LEAD CRYSTAL CLEAR FACETED KNOB

CODE	Knob	Rose	M4	T
FTD670A	25 dia.	18 dia.	36	25
FTD670B	30 dia.	21 dia.	43	25
FTD670C	35 dia.	21 dia.	45	25
FTD670D	40 dia.	23 dia.	51	25

CTB CTC



FTD690

LEAD CRYSTAL CLEAR BALL KNOB

CODE	Knob	Rose	M4	T
FTD690A	27 dia.	28 dia.	40	25
FTD690B	34 dia.	28 dia.	46	25

CTB CTC



DL47

CLASSICAL VICTORIAN KNOB

CODE	Knob	Rose	M4	T
DL47A	25 dia.	30 dia.	27	25 & 62
DL47B	32 dia.	37 dia.	31	25 & 62
DL47C	38 dia.	42 dia.	36	25 & 62
DL47D	45 dia.	47 dia.	42	25 & 62
DL47E	51 dia.	54 dia.	47	25 & 62

ABB CP PB



DK48

DELAMAIN FLOWER KNOB

CODE	Knob	Rose	M4	T
DK48B	27 dia.	32 dia.	33	62
DK48C	32 dia.	38 dia.	39	62

CP PB FB PT

FINGERTIP



DK49

DELAMAIN RINGED KNOB

CODE	Knob	Rose	M4	T
DK49B	28 dia.	30 dia.	29	25 & 62
DK49C	35 dia.	38 dia.	36	25 & 62

CP
 FB
 MSC
 PB
 SN

FINGERTIP



CH30

RINGED KNOB

CODE	Knob	Rose	M4	T
CH30A	17 dia.	17 dia.	18	25
CH30B	20 dia.	20 dia.	21	25
CH30C	24 dia.	24 dia.	26	25

CP
 PB
 SN



FTD245

OVAL PATTERN KNOB

CODE	Knob	Rose	M4	T
FTD245B	34 dia.	14 dia.	32	25

SN
 SC



FTD235

DIMPLE EFFECT KNOB

CODE	Knob	Rose	M4	T
FTD235	28 dia.	12 dia.	24	25
FTD235A	33 dia.	14 dia.	27	25

CP
 SN



FTD3015

HIDDEN FINGER KNOB

CODE	Slotted	T
FTD3015A	25x48x2	18
FTD3015B	50x48x2	18
FTD3015C	75x48x2	18

CP
 SC



FTD255

OVAL KNOB

CODE	Knob	Rose	M4	T
FTD255A	37x19	11x17	22	25

CP
 SN

FINGERTIP



CH6

BALL KNOB

CODE	Knob	Rose	M4	T
CH6A	18 dia.	18 dia.	21	25
CH6B	20 dia.	20 dia.	24	25
CH6C	25 dia.	25 dia.	31	25
CH6D	30 dia.	30 dia.	38	25

CP PB SC



FTD425

STAINLESS STEEL SPHERICAL KNOB

CODE	Knob	Rose	M4	T
FTD425A	25 dia.	25 dia.	29	25
FTD425B	30 dia.	30 dia.	35	25

PS SN SS



FTD345

AZTEC RINGED KNOB

CODE	Knob	Rose	M4	T
FTD345A	24 dia.	12 dia.	20	25
FTD345B	30 dia.	16 dia.	24	25

CP SN

FINGERTIP



FTD515

TRADITIONAL PATTERN KNOB

CODE	Knob	Rose	M4	T
FTD515	34 dia.	20 dia.	2	25 & 62

AB ABB PT SN



FTD125

HOLLOW VICTORIAN KNOB

CODE	Knob	Rose	M4	T
FTD1265A	25 dia.	26 dia.	28	25 & 62
FTD1265B	32 dia.	33 dia.	38	25 & 62
FTD1265C	38 dia.	36 dia.	42	25 & 62

CP PB SC

FINGERTIP



FTD430

STAINLESS STEEL CYLINDRICAL KNOB

CODE	Knob	M4	T
FTD430A	16 dia.	21	25
FTD430B	20 dia.	24	25
FTD430C	25 dia.	30	25
FTD430D	30 dia.	38	25

PS

SS

FINGERTIP



FTD5595

CHEVIOT HANDLE

CODE	M4	T
FTD5595A	128	137 27 25
FTD5595C	224	233 27 25

PE



FTD5625

CHILTERN HANDLE

CODE	M4	T
FTD5625A	128	141 29 25
FTD5625B	160	178 34 25

PE



FTD5532

DIMPLED EFFECT HANDLE

CODE	M4	T
FTD5532	128	154 35 25

PE



FTD525

SHAKER STYLE KNOB

CODE	Knob	Rose	M4	T
FTD525A	29 dia.	16 dia.	22	25 & 62
FTD525B	35 dia.	19 dia.	26	25 & 62

CP

SB

MSC

SN

FTD5542

HAMMERED EFFECT HANDLE

CODE	128	154	28	25
FTD5542	128	154	28	25

PE



FTD1064/1068

HAMMERED FLEUR DE LYS HANDLE

CODE	68	110	36	27
FTD1064B	68	110	36	27
FTD1068B	102	151	33	27

BA PE



FTD1064/1068

DIMPLED FLEUR DE LYS HANDLE

CODE	68	105	35	27
FTD1064A	68	105	35	27
FTD1068A	102	148	39	27

BA



FTD610

CRACKLE GLAZE PORCELAIN HANDLE

CODE	192	205	38	62
FTD610	192	205	38	62

ABIC ASMC



FTD605

CRACKLE GLAZE PORCELAIN HANDLE

CODE	128	151	39	62
FTD605	128	151	39	62

ABIC ASMC



PE5584/BW5584

GOTHIC D HANDLE

CODE	81	106	29	20
PE5584A	81	106	29	20
PE5584B	112	150	42	20
PE5584C	175	200	50	20
BW5584A	81	106	29	20
BW5584B	112	150	42	20
BW5584C	175	200	50	20

BW PE



FINGERTIP



BW5574

BEAN D HANDLE

CODE	79	104	30	20
BW5574A	79	104	30	20
BW5574B	109	148	43	20
BW5574C	186	205	58	20

BW

FINGERTIP



FTD520

SHAKER STYLE HANDLE

CODE	76	128	26	62
FTD520	76	128	26	62

CP **SB** **SN**



FTD1250

STEEL CAGE DROP HANDLE

CODE	128	142	26	25
FTD1250A	128	142	26	25
FTD1250B	160	181	26	25

AS



FTD505

STEPPED EDGE BOW HANDLE

CODE	76	128	24	62
FTD505	76	128	24	62

ABB **AS** **SN**



FTD1240

STEEL CAGE FIXED HANDLE

CODE	128	136	39	25
FTD1240A	128	136	39	25
FTD1240B	160	168	39	25

AS



FTD510

CURVED PATTERN HANDLE



CODE	76	137	25	62
FTD510	76	137	25	62

AB **ABB** **PT**





FTD500

CURVED PATTERN DRAWER HANDLE

CODE    M4



FTD500 76 130 23 62



AA100

CABINET D HANDLE



CODE    M4

AA100 96 104 31 62

AA101 96 104 31 62

AA102 152 160 31 62



AA103 152 160 31 62







FTD555

TRADITIONAL CUP HANDLE

CODE    M4

FTD555 64 104 25 62



  





FTD5515

OVAL PLATE CUP HANDLE

CODE    M4



FTD5515 85 104 26 15







FTD5520

SQUARE PLATE CUP HANDLE

CODE    M4

FTD5520 79x25 90x40 24 15







FTD5525

REEDED CUP HANDLE

CODE	TT	TT	TT	M4	T
FTD5525	84	97	22	15	

 PE



FTD5628

CHILTERN CUP HANDLE

CODE	TT	TT	TT	M4	T
FTD5628	64	110	30	25	



 PE



FTD670

LEAD CRYSTAL CLEAR FACETED KNOB

CODE	Knob	Rose	TT	M4	T
FTD670A	25 dia.	18 dia.	36	25	
FTD670B	30 dia.	21 dia.	43	25	
FTD670C	35 dia.	21 dia.	45	25	
FTD670D	40 dia.	23 dia.	51	25	

 CTB  CTC



FTD690

LEAD CRYSTAL CLEAR BALL KNOB

CODE	Knob	Rose	TT	M4	T
FTD690A	27 dia.	28 dia.	40	25	
FTD690B	34 dia.	28 dia.	46	25	





 CTB  CTC







M1003

QUEEN ANNE KNOB

CODE	Knob	Rose	TT	M4	T
M1003	23 dia.	25 dia.	33	25 & 62	
M1004	28 dia.	30 dia.	41	25 & 62	
M1005	35 dia.	38 dia.	51	25 & 62	

 CP  PB
 FB  SC













FTD1096

HAMMERED OVAL KNOB

CODE Knob Rose 
 FTD1096B 38x29 27 dia. 40 62

















FTD1078

HAMMERED PATTERN BALL KNOB

CODE Knob Rose 
 FTD1078A 27 dia. 36 dia. 36 62
 FTD1078B 33 dia. 36 dia. 42 62

















FTD585

HAMMERED FINISH KNOB

CODE Knob Rose 
 FTD585 32 dia. 17 dia. 27 62
 FTD585A 38 dia. 20 dia. 30 62















FTD5540

HAMMERED EFFECT SQUARE KNOB

CODE Knob Rose 
 FTD5540 32x32 12 dia. 25 25















FTD1098

DIMPLED MUSHROOM KNOB

CODE Knob Rose 
 FTD1098A 34 dia. 22 dia. 34 62







FTD5530

DIMPLED EFFECT SQUARE KNOB

CODE Knob Rose 
 FTD5530 32x32 12 dia. 25 25





DK47

DELAMAIN PLAIN KNOB

CODE Knob Rose ^{M4} T

DK47B 25 dia. 30 62
 DK47C 30 dia. 38 dia. 36 62
 DK47D 38 dia. 48 dia. 45 62



FTD1275

SOLID BRONZE COTTAGE KNOB

CODE Knob Rose ^{M4} T

FTD1275A 38 dia. 35 dia. 34 25



FTD5590

CHEVIOT KNOB

CODE ^{M4} T

FTD5590A 32 20 25



FTD1270

SOLID BRONZE MUSHROOM KNOB

CODE Knob Rose ^{M4} T

FTD1270A 30 dia. 19 dia. 30 25



FTD5620

CHILTERN KNOB

CODE ^{M4} T

FTD5620A 32 35 25
 FTD5620B 38 36 25



DL47

CLASSICAL VICTORIAN KNOB

CODE Knob Rose ^{M4} T

DL47A 25 dia. 30 dia. 27 25 & 62
 DL47B 32 dia. 37 dia. 31 25 & 62
 DL47C 38 dia. 42 dia. 36 25 & 62
 DL47D 45 dia. 47 dia. 42 25 & 62
 DL47E 51 dia. 54 dia. 47 25 & 62





FTD1265

HOLLOW VICTORIAN KNOB

CODE Knob Rose M4
 FTD1265A 25 dia. 26 dia. 28 25 & 62
 FTD1265B 32 dia. 33 dia. 38 25 & 62
 FTD1265C 38 dia. 36 dia. 42 25 & 62



FTD600

CRACKLE GLAZE PORCELAIN KNOB

CODE Knob Rose M4
 FTD600 70x26 26 dia. 46 62



M47

VICTORIAN KNOB

CODE Knob Rose M4
 M47A 25 dia. 25 dia. 25 25 & 62
 M47B 32 dia. 32 dia. 32 25 & 62
 M47C 38 dia. 38 dia. 38 25 & 62
 M47D 42 dia. 42 dia. 42 25 & 62
 M47E 50 dia. 50 dia. 48 25 & 62

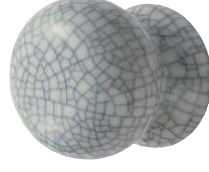

FTD620

PORCELAIN KNOB

CODE Knob Rose M4
 FTD620A 30 dia. 27 dia. 27 62
 FTD620B 35 dia. 31 dia. 30 62
 FTD620C 45 dia. 40 dia. 40 62



CH30

RINGED KNOB

CODE Knob Rose M4
 CH30A 17 dia. 17 dia. 18 25
 CH30B 20 dia. 20 dia. 21 25
 CH30C 24 dia. 24 dia. 26 25





FTD515

TRADITIONAL PATTERN KNOB

CODE Knob Rose    
 FTD515 34 dia. 20 dia. 26 25 & 62



PE1078

CUPBOARD KNOB

CODE    
 PE1078A 22 21 25
 PE1078B 30 25 25
 PE1078C 40 34 25



FTD525

SHAKER STYLE KNOB

CODE Knob Rose    
 FTD525A 29 dia. 16 dia. 22 25 & 62
 FTD525B 35 dia. 19 dia. 26 25 & 62



DK49

DELAMAIN RINGED KNOB

CODE Knob Rose    
 DK49B 28 dia. 30 dia. 29 25 & 62
 DK49C 35 dia. 38 dia. 36 25 & 62



FTD525B not available in SB finish.

DK48

DELAMAIN FLOWER KNOB

CODE Knob Rose    
 DK48B 27 dia. 32 dia. 33 62
 DK48C 32 dia. 38 dia. 39 62

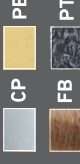

BW1078

BEATEN KNOB

CODE    
 BW1078A 22 21 25
 BW1078B 30 25 25
 BW1078C 40 34 25



PE1078 for matching handle PE6564 see P479. BW1078 for matching handle BW5684 see P479.



FTD1210

STEEL CAGE BALL KNOB

CODE	Knob	Rose	M4	T
FTD1210A	34 dia.	12 dia.	56	25
FTD1210B	42 dia.	14 dia.	60	25

AS



FTD1220

STEEL CAGE MUSHROOM KNOB

CODE	Knob	Rose	M4	T
FTD1220A	34 dia.	12 dia.	31	25
FTD1220B	44 dia.	14 dia.	40	25

AS



FTD1230

STEEL CAGE OVAL KNOB

CODE	Knob	Rose	M4	T
FTD1230A	55	12 dia.	33	25
FTD1230B	65	14 dia.	35	25

AS

FTD1210 for matching handles see P480.
 FTD1220 for matching handles see P480.
 FTD1230 for matching handles see P480.



FTD540

CELTIC PATTERN KNOB

CODE	Knob	Rose	M4	T
FTD540	30 dia.	14 dia.	25	25

AB **PT**



FTD575

STEEL CAGE KNOB

CODE	Knob	Rose	M4	T
FTD575	124	20 dia.	53	62

AB **AS** **BA**



FTD1096

OVAL KNOB

CODE	Knob	Rose	M4	T
FTD1096A	38x28	26 dia	39	25
FTD1096B	38x28	26 dia	39	25

FTD1096A = Smooth Finish
 FTD1096B = Hammered Finish

BA **PE**

FTD1096A not available in PE finish.



FTD1044

RING PULL ON GOTHIC CROSS BACKPLATE

CODE	Knob	Rose	Pull	M4
FTD1044	57x57	42 dia.	23	25

BA



FTD815

DOUBLE BALL CATCH

CODE	L x W x H
FTD815A	43x8
FTD815B	50x9.3
FTD815C	60x11.5
FTD815D	70x13.5

AB **SC** **SCOL**



FTD1078

HAMMERED PATTERN BALL KNOB

CODE	Knob	Rose	M4
FTD1078A	27 dia.	37 dia.	36
FTD1078B	32 dia.	37 dia.	42

BA **PE**



FTD840/850

SUPERIOR STEEL MAGNETIC CATCH

CODE	L x W x H	Weight
FTD840	46x15x14	6.0Kg pull
FTD850	46x15x14	3.5Kg pull

EB **FB** **NP**



FTD5620

HAMMERED BALL KNOB ON BACKPLATE

CODE	Knob	Rose	M4
FTD1074A	63x63	27 dia.	38
FTD1074B	63x63	32 dia.	43

BA



FTD820

PREMIUM CABINET BUTT HINGE

CODE	L x W x H
FTD820D	64x35x2

AB **CP** **PB** **PE** **SC** **SB**



FTD810

BRASS H PATTERN HINGE

CODE L x W x H
 FTD810 63x38x2.5

AB POL/LAC



FTD805

FINAL CABINET HINGE

CODE L x W x H
 FTD805C 50x28x1.5
 FTD805D 64x35x2

Add 6mm to either end for fitial ends.

AB PB SC



FTD800

CABINET HINGE

CODE L x W x H
 FTD800C 50x28x1.5
 FTD800D 64x35x2

AB PB SCOL

CP SC



FTD855

HEAVY PATTERN CABLE TIDY

CODE Insert
 FTD855 60mm

CP EB SN

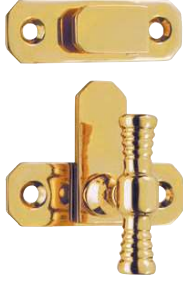

WF13

T HANDLE FASTENER

CODE Count
 WF13 57x19 23

CP PB SC



H4.170.35

SOFT CLOSE HINGE

CODE
 H4.170.35.10
 170 degree soft close Hinge

NP

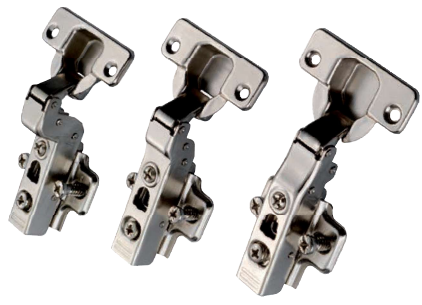

H4.100.35

SOFT CLOSE HINGE

CODE

H4.100.35.30
Inset Soft Close Hinge

H4.100.35.20
Half Overlay Soft Close Hinge

H4.100.35.10
Full Overlay Soft Close Hinge

NP



AB - Antique Brass

ABB - Antique Burnished Brass

ABIC - Antique Brass/Ivory Crackle Glaze

ACC - Acrylic Clear Chrome

AS - Antique Steel

ASMC - Antique Steel/
Midnight Blue Crackle Glaze

BA - Black Antique

BEP - Black Electro Plated

BLACK - Black

BL - Black

BLK - Black

BN - Black Nickel

BR - Brown

BR000 - Bronze Plated

BROWN - Brown

BSS - Bright Stainless Steel

BSS/SSS Bright Stainless Steel/
Satin Stainless Steel

BW - Beeswax

BZP - Bright Zinc Plated

CP - Polished Chrome

CPMC - Polished Chrome/Matt Chrome

CPMSC - Polished Chrome/
Matt Satin Chrome



CPSC - Polished Chrome/Satin Chrome

CPSN - Polished Chrome/Satin Nickel

CPWH - Polished Chrome/White

CTB - Clear Translucent Brass

CTC - Clear Translucent Chrome

DB - Dark Bronze

EB - Electro Brassed

FB - Florentine Bronze

FBIC - Florentine Bronze/
Ivory Crackle Glaze

GAA - Gold Anodised Aluminium

GALV - Galvanised

GN - Green

GOLD - Gold

IC - Ivory Crackle Glaze

ICFB - Ivory Crackle Glaze/
Florentine Bronze

JAP - Black Japanese

MC - Matt Chrome

MCCP - Midnight Blue Crackle/
Polished Chrome

MSC - Matt Satin Chrome

MSN - Matt Satin Nickel

NB - Black Nickel

NIK00 - Nickel Plated



P4.100.35

MOUNTING PLATE

CODE

P4.100.35.00
Mounting Plate

P4.100.35.02
Mounting Plate

P4.100.35.A00
Adjustable Plate

NP

P4.100.35.00 and P4.100.35.02 supplied with 14x6mm euro screws.
P4.100.35.A00 not supplied with screws.

KEY TO FINISHES

	NP - Nickel Plated
	OTT00 - Brass Plated
	PAA - Polished Anodised Aluminium
	PB - Polished Brass
	PBKCP - Porcelain Black/ Polished Chrome
	PC - Polished Chrome
	PCB - Powder Coat Black
	PCSC - Polished Chrome/Satin Chrome
	PE - Pewter
	PG - Polished Gold
	PIV - Porcelain Ivory
	PLW - Plain White/Polished Brass
	PLWCP - Plain White/Polished Chrome
	PNP - Polished Nickel Plated
	PNSN - Polished Nickel/Satin Nickel
	POL/LAC - Polished/Lacquered
	PS - Polished Stainless
	PT - Pewter
	PVD - Stainless Brass
	PWH - White Porcelain
	PWSC - White Porcelain/Satin Chrome
	SAA - Satin Anodised Aluminium
	SB - Satin Brass
	SBPB - Satin Brass/Polished Brass

	SC - Satin Chrome
	SCCP - Satin Chrome/Polished Chrome
	SCOL - Self Colour
	SN - Satin Nickel
	SNP - Satin Nickel Plated
	SNSS - Satin Nickel/Stainless Steel
	SS - Stainless Steel
	SSCP - Stainless Steel/Polished Chrome
	SSE - Stainless Steel Effect
	SSS - Satin Stainless Steel
	SSSC - Satin Stainless Steel/ Satin Chrome
	SV - Silver
	SZP - Satin Zinc Plate
	VCH00 - Stainless Steel Plated
	WHITE - White
	WHT - White
	W - White
	WWPB - Wood Walnut/Polished Brass
	WOSC - Wood Oak/Satin Chrome
	ZP - Zinc Plate

KEY TO SYMBOLS

	Industrial		Commercial		Domestic		2 Year Electrical		2 Year Mechanical		5 Year Mechanical		10 Year Mechanical		25 Year Mechanical
Suitable Environments For Use:		Guarantees:													
	BS 8300 is the design of buildings and their approaches to meet the needs of disabled people.		CE MARKING is certification to the highest levels of attestation required by the Construction Products Directive. The CE mark indicates that the product has been successfully 3rd party performance/fire tested and that the producing factory has passed stringent Factory Production Control audits, carried out by a UKAS notified certification.												
	CERTIFIRE is an independent 3rd party scheme providing high quality, voluntary, product conformity for the passive fire sector. Certifire is product certification at a higher level than CE. Additional requirements are ISO:9001:2000 certification, independent audit testing and a comprehensive field of application document based on carefully chosen tests. Designed to give confidence to specifiers, enforcement authorities and building owners/occupiers, the Certifire scheme is recognised by regulatory authorities both in the UK and overseas.		KITEMARK is the world's premier symbol of trust, integrity and quality. Manufacturers having this associated with their product or service will reassure customers and specifiers alike that they have satisfied the most rigorous of quality processes.												
	TS 007:2015 is the Kite-marked security standard for replacement lock cylinders and protective door furniture. A technical specification created for the industry in response to growing concerns that domestic homes are under threat from attack due to readily available information on the internet.		BS EN 1634 is the European Fire Safety Standard for determining the fire resistance of door and shutter assemblies, including door hardware:												
	FD30 30 minute fire doors		FD30/60/120 30/60/120 minute fire doors		FD120/240 120/240 minute steel fire doors										



BS EN 179

BS EN 179 is the British/European standard requirements and testing methods covering panic exit devices operated by a lever handle or push pad.



BS EN 1125

BS EN 1125 is the British/European standard requirements and testing methods covering panic exit devices operated by a horizontal bar.



BS EN 1154

BS EN 1154 is the British/European standard requirements and testing methods covering controlled door closing devices.



BS EN 1155

BS EN 1155 is the British/European standard requirements and testing methods covering electronically powered hold open devices.



BS EN 1303

BS EN 1303 is the British/European standard requirements and testing methods covering cylinders for locks.



BS EN 1670

BS EN 1670 is the British/European standard requirements and testing methods covering corrosion resistance.



BS EN 1906

BS EN 1906 is the British/European standard requirements and testing methods covering lever handles and knob furniture.



BS EN 1935

BS EN 1935 is the British/European standard requirements and testing methods covering single axis hinges.



BS EN 12209

BS EN 12209 is the British/European standard requirements and testing methods covering locks, latches and locking plates.



SECURED BY DESIGN is the UK policed flagship initiative supporting the principles of “designing out crime” prevention and security standards for a range of applications and products showing their logo have met the standards identified by this organisation. A full list of licensed products can be found on the website www.securedbydesign.com

CYLINDERS FEATURES AND BENEFITS



Anti-Drill



Break-Off System



Anti-Plug Pull



Anti-Pick



Anti-Bump

INTUMESCENT FEATURES AND BENEFITS



Acoustically Tested



Smokeproof

BEESWAX

The combination of hand forged metal finished with wax. Due to the simplicity, the finish is essentially everlasting as long as it is maintained correctly with Carlisle Brass wax. Sometimes because of temperature changes your product may have a slight white bloom, we recommend that you polish it with a soft cloth and a small amount of maintenance wax to restore the finish. If your product is fitted in a damp area such as a bathroom it may have the potential to exhibit surface rust. If this occurs we recommend that the product is cleaned with fine wire wool and Carlisle Brass maintenance wax is applied to restore the finish. The use of maintenance wax is necessary to restore finish and afford protection to the beeswax range of products. If surface rust occurs then simply rub the affected area with wire wool and apply the maintenance wax with a rag or brush. It is important to note that where mechanical parts come together and there is abrasive movement, the wax surface will eventually be lost. We recommend that you oil these moving parts occasionally NB: there may be very slight colour or size differences with these products as every item is hand forged. Where this would be a problem with other ironmongery products we feel it enhances the appeal of this range.

BLACK ANTIQUE

Iron in any form, whether cast or malleable, is susceptible to rusting. During our finishing process we make every effort to cover all areas of our black ironmongery with an epoxy coating. They are first pre baked to approximately 1500C before receiving a spray coating, then finally baked in an electric oven at approximately 2000C. Unavoidably when two areas of metal come into contact with each other an abrasive action is enacted, and eventually the painted surfaces are lost by the continuous rubbing action. This is inevitable during the operational activity of the item, so where obvious abrasive areas of moving parts are visible an occasional light oiling is recommended. This will help to prolong the aesthetic appearance and keep the rusting process at bay. To remove harmful deposits which will cause corrosion (this is even more critical near to a coastline, as the salt air has a very corrosive effect on iron) we advise that the ironmongery is regularly wiped over with a lightly oiled cloth.

BRASS

Our brass products are protected by the most advanced lacquer available and under normal circumstances should give many years of service. They should be cleaned with a cloth moistened with soapy water or alternatively wiped over with a soft cloth with beeswax. **UNDER NO CIRCUMSTANCES USE ANY FORM OF METAL CLEANER OR AEROSOL SPRAYS.** However, after a period of time the lacquer coating, especially on external fittings, can suffer a possible breakdown. Therefore, the life of the lacquer is beyond the manufacturer's control and cannot be guaranteed. When the lacquer coating has broken down, remove the brass fittings and coat using a soft brush with acetone thinner e.g. 'Nitramores' according to the manufacturer's instructions. Completely dry the product using a soft cloth and metal polish, such as "Brasso" or 'Duraglit'. At this stage the product can either be re-lacquered or polished as and when required. A fresh coat of lacquer may be applied, but we strongly recommend that, especially for external use, you should leave the item unacquered.

CHROME

Our chrome products are virtually maintenance free. However, deposits will accumulate especially on external fittings. We therefore recommend regular cleaning with a soft cloth and non-abrasive wax polish.

PEWTER

This finish is extremely durable both internally and externally. Pewter finish is electro plated and then stove lacquered and requires no more than an occasional wipe with a damp cloth and some soapy water.

STAINLESS BRASS PVD

These products have an advanced vacuum treated process and we can offer a full 25 year replacement guarantee with the exclusive stainless brass finish. The technology involved in this process renders this surface impervious to damage in normal use including oxidation, wear and abrasion. We recommend the removal of surface dirt by dusting with a soft cloth. Stubborn stains can be removed with the use of white spirit or similar based products.

STAINLESS STEEL

Stainless steel is protected from corrosion by a thin layer of chromium oxide. Oxygen from the atmosphere combines with the chromium in the stainless steel to form this passive chromium oxide film that protects from further corrosion. Any contamination of the surface by dirt, or other material hinders this passivation process and traps corrosive agents, reducing corrosion protection. Thus some form of routine cleaning is necessary to preserve the appearance and integrity of the surface. Stainless steels are easily cleaned by many different methods. They actually thrive with frequent cleaning and, unlike some other materials, it is possible to 'wear out' stainless steel by excessive cleaning. Cleanliness is essential for maximum resistance to corrosion. All exposed stainless steel surfaces should be wiped over with a clean cloth and warm water with a mild detergent on a frequent and routine basis. For more stubborn dirt or stains use mild, non-scratching abrading powders such as typical household cleaners. These can be used with warm water, bristle brushes, sponges or clean cloths. For more aggressive cleaning a small amount of vinegar can be added to the powder. Carbon steel brushes and steel wool should be avoided as they may leave particles embedded in the surface, which can lead to rusting. Cleaning should always be immediately followed by rinsing in clean hot water and the surface then wiped completely with a dry towel. The maximum recommendation for routine cleaning is once a month and more often in areas subject to heavy soiling or frequent use.

Where routine maintenance is considered a prerequisite of compliance with an associated guarantee a 'Maintenance Log' should be kept for each installation.

INDEX

PE5	49
PE55	295
PE5501-6	287
PE55101	296
PE5520B-E	288
PE5524	295
PE5530A-B	291
PE5535	289
PE5540A-C	293
PE5541A-C	293
PE5546C/O	295
PE5550	297
PE5563A-B	291
PE5564A-B/PE5565A-B	290
PE5574	296
PE5584/BW5584	289
PE5584A-C	289
PE5590	298
PE5634	294
PE56490-9	297
PE5654	294
PE56NP92	288
PF100-102	142
PF103-105	143
PF106-107	144
PF108	141
PF109	145
PF110	145
PFC1300-PFD1300	91
PFD4225-4300	195
PDF9150-9600	209
PFT1225-1300	92
PH110/PH160	26
PH3115/PH3121	27
PH500	26
PH52	27
PL4-5	234
PLB-PLT9001	216-217
PLW/PLWCP	120
PSUA8/WHT	345
RBH1433	305
RCB8260	390
RCN8160	391
RCN8240-60	390
RCN8340-60	390/391
RCP1000	117
RCP4000	200
RCP9000	213
RDE8043/RLE8043	387
RSE8053/RSE8064	387
RSL5030	394
SAA21-22/SAA50	204
SAA23/SAA26	206
SAA28/SAA60-61	205
SAAIND	206
SCH14325/13	311
SEX1011-21	114
SEX4011-19	199
SL1-3	168
SP104/SP104L	221
SSD1415-SSF1460	88
SSK1062	106

SSL1401-3	64
SSL1404-6	65
SSL1407	66
SSM1415-SSM1460	89
SSP1405	66
SSR1405	89
SST1415/SST1415i	66
SSU1405	66
SW10	79
SW102-107	84
SW11-12	79
SW120	82
SW122-124	79
SW125-126	80
SW127	79
SW13/SW14	80
SW134	94
SW140-141	83
SW15	79
SW16-18	81
SW19	82
SW4123X	85
SWE1000/SWE1010/SWE1030	110
SWE1020/SWE1040	111
SWE1050/SWE1062	112
SWKNR1058	106
SWL1006-9	68
SWL1010	69
SWL102-3	76
SWL1121-22	69
SWL1126-31	70
SWL1132-34	71
SWL1135-61	72
SWL1162-65	73
SWL1166-68	74
SWL1190-92	75
SWL1194-96	76
SWLP123	102
SWNP11/SWNP120	107
SWNP40-41	108
SWOB-SWOU	102
SWP18/300/SWP18/600	93
SWP19/300/SWP19/600	94
SWP1134	87
SWR1137	77
SWT1016/i-SWT1025i	77
SZ500	15
SZ5004	16
SZC001-4	8
SZC010-30	6
SZC011-13	29
SZC021-23	29
SZC031-33	30
SZC040-50	7
SZC041-43	30
SZC051-53	31
SZC330	7
SZC340	8
SZM001-3	15
SZM001-3SQ/SZM004	16
SZM004SQ	17
SZM014-26	10

SZM034-36/SZM044-46	33
SZM055-57/SZM066-68	34
SZM100-130	11
SZM160-210	12
SZM210SQ/SZM220-30	13
SZM241-43	35
SZM250-370	14
SZM371-373	35
SZM380	15
SZS010NP92-030NP92LH/RH	161
SZS060-80	37
SZS12NP92LH/RH	162
SZS130/SZS350	38
SZS44B-S/SZS73	408
TC5	50
TL1-4	388
TLD5030-5850	399
TLM5030-TLS8030	400
ULE5025-30	385
ULS5025-30	398
UO5	50
URBS5025-30/URES5025-30	401
URLS5325-5530	400
UROS5025-30	401
V1005/V1005LCK	417
V1006LCK/V1008LH/RH	415
V1007LCK	416
VW5526	282
WD5	50
WF11/WF16	416
WF12B-S	412
WF13	499
WF14/WF15/WF17	414
WF21/WF35	410
WF22-25	411
WF30-32	409
WSB8125	387
XDB/XDD/XDL5760	347
XIA5000H/V	349
XIA5002-4	350
XIA5012	349
XIA5014/17	347
XID5120/XID5760V	349
XIT5120/XIT5760	349
XIT5760H/XIT5760V	349
XSA5002/03	348
XSD5760V	348
XSL5760/H/V	348
ZEE-ZEU3005	25
ZIN3003-111	19
ZIN3112-114	20
ZIN3115-117	21
ZIN3118-127	22
ZIN3129-131	23
ZIN3138-140	24
ZIN3144	25



It is our policy to distribute our products through a strong network of trade outlets namely architectural ironmongers and builders' merchants, throughout the UK. We pride ourselves on our nationwide team of knowledgeable specification and sales representatives, who are there to assist and support both our distribution network and end customers.

For information regarding the suitability of products in certain environments e.g. coastal areas and environments with high air pollution please contact our sales office on 01228 511030.

Terms and conditions are available online or upon request.

All sizes are approximate and we reserve the right to change them where necessary and without notice. Colours may vary slightly from the actual product due to photography and printing techniques. All errors and omissions excepted.



Carlisle Brass Ltd. Parkhouse Road, Carlisle, Cumbria, CA3 0JU
Sales: 01228 511030 Email: sales@carlislebrass.com Web: www.carlislebrass.com