

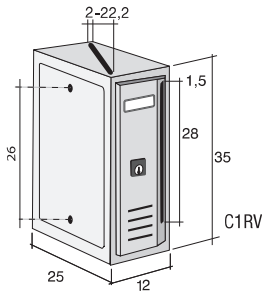

Esempi di composizione a blocchiera con sviluppo verticale  
*Examples of possible vertical assembly*

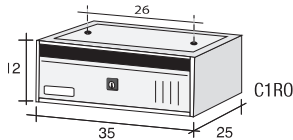

Esempi di composizione a blocchiera con sviluppo orizzontale  
*Examples of possible horizontal assembly*



C1RVGH



C1RVBR



C1ROGH



C1ROBR

(confezione da 10 pezzi)

**PER INTERNI**  
Modello componibile

**VERTICALE**

- C1RVBR • In alluminio anodizzato bronzo
- C1RVGH • In alluminio verniciato ghisa

**ORIZZONTALE**

- C1ROBR • In alluminio anodizzato bronzo
- C1ROGH • In alluminio verniciato ghisa

Corpo forato sui lati per unione di più casellari

(10-pieces package)

**INDOORS - MAGAZINE FORMAT**  
Modular model

**VERTICAL**

- C1RVBR • Aluminium - bronze anodized
- C1RVGH • Aluminium - cast-iron grey paint finish

**HORIZONTAL**

- C1ROBR • Aluminium - bronze anodized
- C1ROGH • Aluminium - cast-iron grey paint finish

Predisposed for assembly of several mailbox units.



C5GH  
Ghisa/Cast-iron grey



C6AR  
Argento/silver



C6BR  
Bronzo/bronze

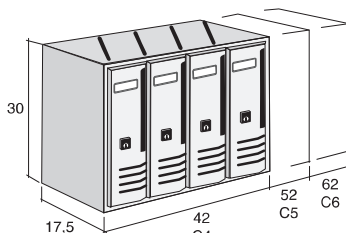

(confezione da 2 pezzi)

**PER INTERNI**

Corpo preforato sui lati per unione di più casellari.

- C4 • Blocchiera a 4 cassette in alluminio anodizzato bronzo e argento o verniciato ghisa cm 30 x 42 x 17,5
- C5 • Blocchiera a 5 cassette in alluminio anodizzato bronzo e argento o verniciato ghisa cm 30 x 52 x 17,5
- C6 • Blocchiera a 6 cassette in alluminio anodizzato bronzo e argento o verniciato ghisa cm 30 x 62 x 17,5

(2-pieces package)

**INDOORS**

Predisposed for assembly of several mailbox units.

- C4 • 4 unit mailbox set. Anodized aluminium bronze and silver, or cast-iron grey paint finish 30 x 42 x 17.5 cm
- C5 • 5 unit mailbox set. Anodized aluminium bronze and silver, or cast-iron grey paint finish 30 x 52 x 17.5 cm
- C6 • 6 unit mailbox set. Anodized aluminium bronze and silver, or cast-iron grey paint finish 30 x 62 x 17.5 cm

**CASSETTE E CASELLARI POSTALI CONDOMINIALI  
MAILBOXES AND MAILBOX UNITS FOR CONDOMINIUM**

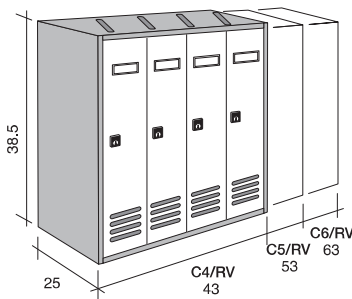

C4RVGH  
Ghisa/Cast-iron grey



C5RVOR0: Oro/gold



C5RVBR  
Bronzo Anticato/antique bronze



C6RVIX: Inox

(confezione da 1 pezzo)

**PER INTERNI**

Corpo in lamiera elettrozincata verniciata alle polveri colore ghisa con sportello inox o verniciato bronzo antico, ghisa e oro.

Corpo preforato sui lati per unione di più casellari.

**VERTICALE**

- C4RV** • Blocchiera a 4 cassette
- C5RV** • Blocchiera a 5 cassette
- C6RV** • Blocchiera a 6 cassette

**INDOORS - MAGAZINE FORMAT**

**Modular model**

Electrogalvanized sheet steel body, cast-iron grey epoxy powder painted, matt finish. Antique bronze, cast-iron grey, gold painted door or S/S door.

Predisposed for assembly of several mailbox units.

**VERTICAL**

- C4RV** • 4 unit mailbox set
- C5RV** • 5 unit mailbox set
- C6RV** • 6 unit mailbox set

**CASSETTE E CASELLARI POSTALI CONDOMINIALI  
MAILBOXES AND MAILBOX UNITS FOR CONDOMINIUM**

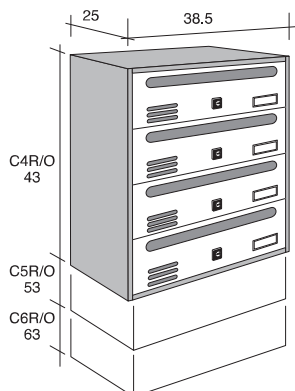

C4R0BR  
Bronzo Anticato/antique bronze



C6R0IX  
inox



C5R0GH:  
ghisa/cast-iron grey



C4R0OR0  
Oro/gold

(confezione da 1 pezzo)

**PER INTERNI**

Corpo in lamiera elettrozincata verniciata alle polveri colore ghisa con sportello inox o verniciato bronzo antico, ghisa e oro.

Corpo preforato sui lati per unione di più casellari.

**ORIZZONTALE**

- C4RO** • Blocchiera a 4 cassette
- C5RO** • Blocchiera a 5 cassette
- C6RO** • Blocchiera a 6 cassette

(1-piece package)

**INDOORS - MAGAZINE FORMAT**

Electrogalvanized sheet steel body, cast-iron grey epoxy powder painted, matt finish. Antique bronze, cast-iron grey, gold painted door or S/S door.

Predisposed for assembly of several mailbox units.

**HORIZONTAL**

- C4RO** • 4 unit mailbox set
- C5RO** • 5 unit mailbox set
- C6RO** • 6 unit mailbox set



J4VEAR  
Argento/Silver



J5VEAR  
Argento/Silver



J6VEAR  
Argento/Silver

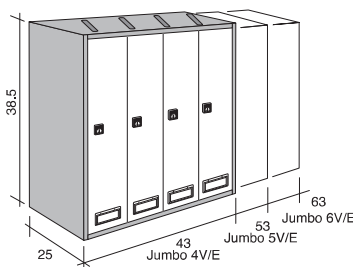

(confezione da 1 pezzo)

**PER INTERNI**

Corpo in lamiera elettrozincata verniciata alle polveri colore ghisa e sportello in profilato d'alluminio disponibile nei colori:

- anodizzato argento
- anodizzato bronzo
- verniciato rosso
- verniciato bianco
- verniciato verde
- verniciato ghisa

Corpo perforato sui lati per unione di più casellari.

((1-piece package)

**INDOORS - MAGAZINE FORMAT**

Electrogalvanized sheet steel body, cast-iron grey epoxy powder painted, matt finish.

Aluminium profile door. Colors available:

- anodized - silver
- anodized - bronze
- painted - red
- painted - white
- painted - green
- painted - cast-iron grey

Predisposed for assembly of several mailbox units.



MADE IN ITALY

CASSETTE E CASSELLARI POSTALI CONDOMINIALI - MAILBOXES AND MAILBOX UNITS FOR CONDOMINIUM

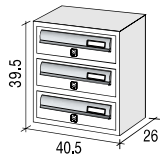

**JUMBO 3**  
Blocchiera  
da 3 cassette  
3 unit mailbox set

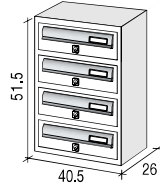

**JUMBO 4**  
Blocchiera  
da 4 cassette  
4 unit mailbox set

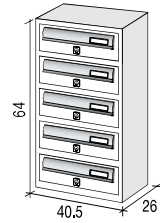

**JUMBO 5**  
Blocchiera  
da 5 cassette  
5 unit mailbox set



J3BR



J4RO



J5AR



I modelli Jumbo 3, 4 e 5 montano gli sportelli della Modular 1 (SP1), vedi a pag. 53.  
Jumbo 3, 4, 5 models need SP1 doors (see pag. 53).

Non abbinabile al JUMBO 6/8/10 - Not assemble together with 6/8/10 models.

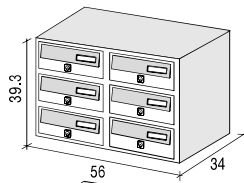

**JUMBO 6**  
Blocchiera da  
6 cassette  
6 unit mailbox set

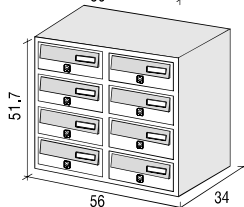

**JUMBO 8**  
Blocchiera da  
8 cassette  
8 unit mailbox set

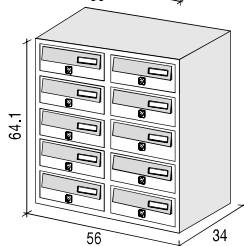

**JUMBO 10**  
Blocchiera da  
10 cassette  
10 unit mailbox set



J6BR



J8AR



I modelli Jumbo 6, 8 e 10 montano gli sportelli della Modular 270/1 (SP270/1), vedi a pag. 63.  
Jumbo 6, 8, 10 models need SP1/270 doors (see pag. 63).

Non abbinabile al JUMBO 3/4/5 - Not assemble together with 3/4/5 models.



Tutti i modelli Jumbo sono accessoriabili con citofono, campanelli e telecamera della Serie Bticino Sfera (vedi da pag.71).

All JUMBO models can be provided with intercom, doorbells and video camera for Bticino Sfera Series (from page 71)

Tutti i modelli Jumbo possono essere montati con la piantana standard Modular (vedi a pag. 68).

All Jumbo models can be mounted with Modular support column (see page 68)

(confezione da 1 pezzo)

#### PER ESTERNO PROTETTO

Corpo in lamiera elettrozincata verniciata alle polveri colore ghisa e sportello SP1 completo di elemento mobile in profilato d'alluminio

- anodizzato argento
- anodizzato bronzo
- verniciato nero
- verniciato rosso con elemento mobile ghisa
- verniciato bianco
- verniciato verde con elemento mobile ghisa
- verniciato ghisa
- SP - OTT - con elemento mobile in ottone.

(1-piece package)

#### OUTDOORS - SHELTERED LOCATION MAGAZINE FORMAT

Electrogalvanized sheet steel body, cast-iron grey epoxy powder painted, matt finish.

Aluminium profile SP1 door with flap

- anodized - silver
- anodized - bronze
- painted - black
- painted - red, with cast-iron grey flap
- painted - white
- painted - green, with cast-iron grey flap
- painted - cast-iron grey
- SP - OTT - door with brass flap.



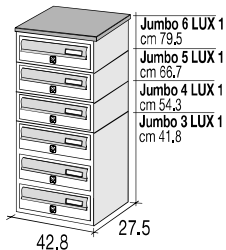

Jumbo 6 LUX 1  
cm 79,5  
Jumbo 5 LUX 1  
cm 66,7  
Jumbo 4 LUX 1  
cm 54,3  
Jumbo 3 LUX 1  
cm 41,8

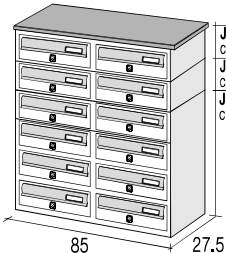

Jumbo 12 LUX 1  
cm 79,5  
Jumbo 10 LUX 1  
cm 66,8  
Jumbo 8 LUX 1  
cm 54,3

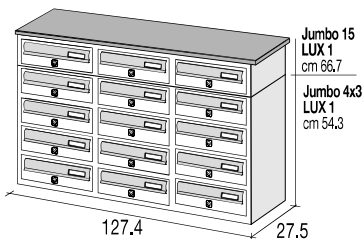

Jumbo 15  
LUX 1  
cm 66,7  
Jumbo 4x3  
LUX 1  
cm 54,3



Ritiro frontale  
Front access



Tutti i modelli Jumbo LUX1 sono accessoriabili con citofono, campanelli e telecamera della Serie Bticino Sfera (vedi da pag. 71).

All JUMBO LUX1 models can be provided with intercom, doorbells and video camera for Bticino Sfera Series (see page 71)

(confezione da 1 pezzo)

**PER ESTERNO**

Corpo in lamiera elettrozincata verniciata alle polveri colore ghisa e sportello SP1 completo di elemento mobile in profilato d'alluminio. Corpo preforato sui lati per unione di più casellari.

- anodizzato argento
- anodizzato bronzo
- verniciato ghisa
- verniciato bianco
- verniciato rosso con elemento mobile ghisa
- verniciato verde con elemento mobile ghisa

• **SP - OTT**  
con elemento mobile in ottone.

(1-piece package)

**OUTDOORS - MAGAZINE FORMAT**

Electrogalvanized sheet steel body, cast-iron grey epoxy powder painted, matt finish. Aluminium profile SP1 door with flap. Predisposed for assembly of several mailbox units.

- anodized - silver
- anodized - bronze
- painted - cast-iron grey
- painted - white
- painted - red, with cast-iron grey flap
- painted - green, with black flap

• **SP - OTT**  
door with brass flap.

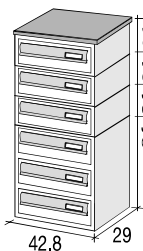

Jumbo 6 LUX 2  
cm 79,5  
Jumbo 5 LUX 2  
cm 66,7  
Jumbo 4 LUX 2  
cm 54,3  
Jumbo 3 LUX 2  
cm 41,8

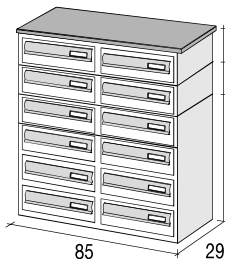

Jumbo 12 LUX 2  
cm 79,5  
Jumbo 10 LUX 2  
cm 66,7  
Jumbo 8 LUX 2  
cm 54,3



J03LUX2  
Fronte - Front view



J03LUX2  
Retro - Rear view



Tutti i modelli Jumbo LUX2 sono accessoriabili con citofono, campanelli e telecamera della Serie Bticino Sfera (vedi da pag. 71).

All JUMBO LUX2 models can be provided with intercom, doorbells and video camera for Bticino Sfera Series (see page 71)



(confezione da 1 pezzo)

**PER ESTERNO**

Corpo in lamiera elettrozincata verniciata alle polveri colore ghisa e sportello SP2 completo di elemento mobile in profilato d'alluminio. Corpo preforato sui lati per unione di più casellari.

- anodizzato argento
- anodizzato bronzo
- verniciato ghisa
- verniciato bianco
- verniciato rosso con elemento mobile ghisa
- verniciato verde con elemento mobile ghisa

• **SP - OTT**  
con elemento mobile in ottone.

(1-piece package)

**OUTDOORS - MAGAZINE FORMAT**

Electrogalvanized sheet steel body, cast-iron grey epoxy powder painted, matt finish. Aluminium profile SP2 door with flap. Predisposed for assembly of several mailbox units.

- anodized - silver
- anodized - bronze
- painted - cast-iron grey
- painted - white
- painted - red, with cast-iron grey flap
- painted - green, with black flap

• **SP - OTT**  
door with brass flap.

La serie Jumbo LUX è adatta anche ad installazioni esterne non protette

Jumbo LUX series is suitable to be installed also in not sheltered external place



Tutti i modelli Jumbo LUX possono essere montati con la piantana standard Modular (vedi a pag. 68).

All Jumbo LUX models can be mounted with Modular support column (see page 68)

MODELLO CONFORME NORME EUROPEE  
**EN 13724**

**Made in Italy**

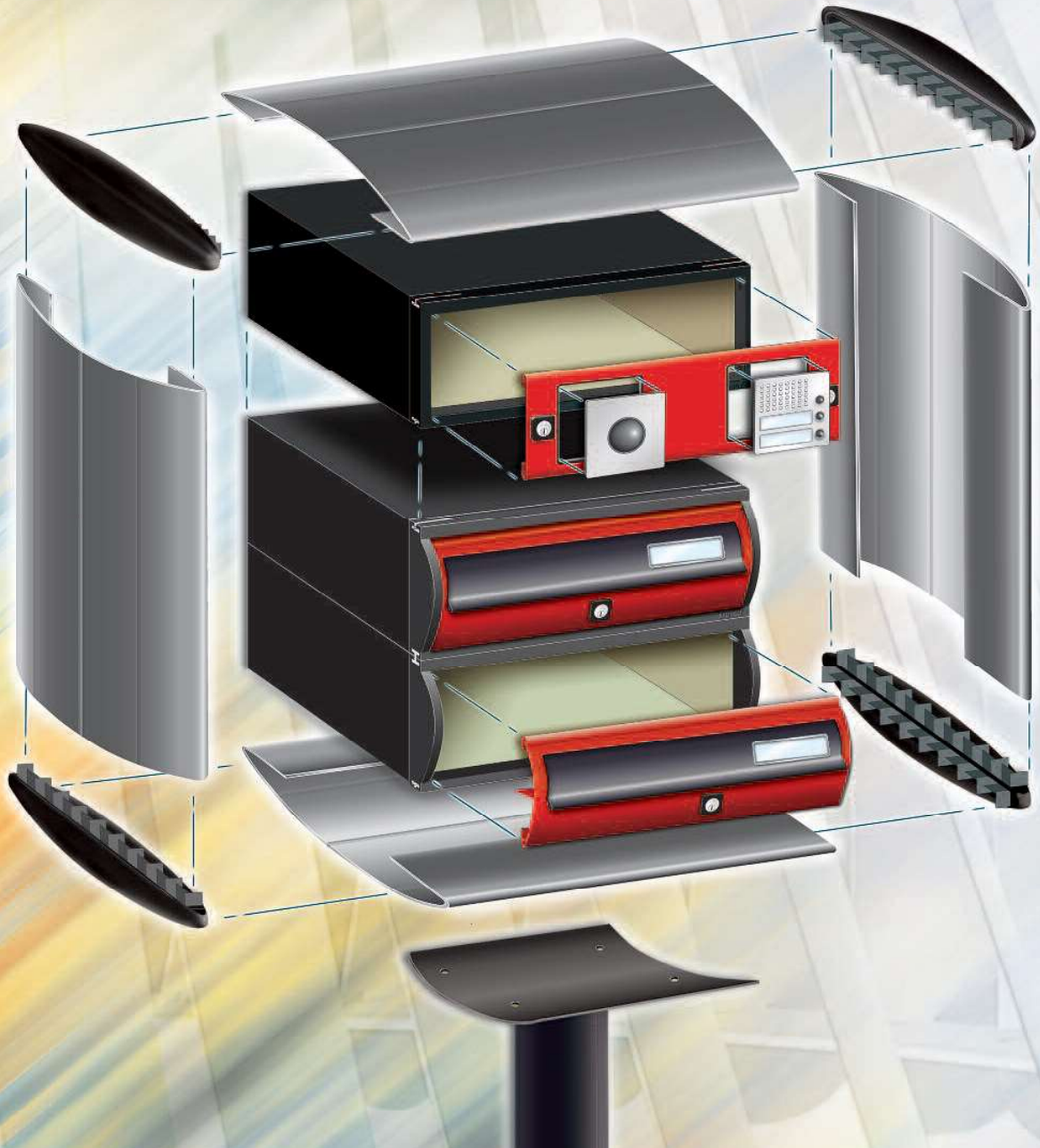

CASSETTE POSTALI COMPONENTI  
**Serie CURVE e Modular**  
MAILBOX UNITS FOR CUSTOM CONFIGURATION  
**CURVE and MODULAR Series**



**MODELLO CONFORME**  
**NORME EUROPEE**  
**EN 13724**

*Le norme EN 13724 sono una realtà in tutti gli Stati dell'Unione Europea. In sintesi, le norme EN, impongono il rispetto di determinate regole nella produzione delle cassette postali, quali: dimensioni, materiali, robustezza e sicurezza.*

**Le Casette Postali della Serie MODULAR e della Serie CURVE sono conformi alle normative EN 13724**



Nella vasta gamma di prodotti che Alubox offre la Serie MODULAR e la Serie CURVE sono le linee di punta.

Alubox si propone, attraverso il Progetto MODULAR, di soddisfare un sempre maggior numero di richieste, realizzando cassette postali modulari componibili.

Le caratteristiche fondamentali di tutta la serie MODULAR e la serie CURVE sono senza dubbio la versatilità, la resistenza nel tempo, l'estetica e la funzionalità.

Nella progettazione della Serie MODULAR e Serie CURVE si è tenuto rigorosamente conto delle nuove Normative Europee EN 13724.

Tali normative prevedono la regolamentazione della produzione delle cassette postali in fatto di dimensioni, in quanto devono essere in grado di contenere riviste, avere caratteristiche anti effrazione ed essere realizzate in modo tale da salvaguardare la privacy e la sicurezza delle persone.

## VERSATILITÀ

I nostri casellari sono adatti a qualsiasi tipo di installazione: da incasso totale oppure parziale a muro, fissaggio a parete, recinzione, su piantana per l'esterno, complete di mantello o cornice coprifuga a seconda del tipo di ubicazione.

Utilizzando appositi sportelli o placche porta accessori si possono predisporre tutti i casellari di campanelli, citofoni, telecamere e numeri civici delle migliori e più diffuse marche presenti sul mercato (gli accessori non sono direttamente forniti).

## RESISTENZA

I materiali utilizzati per la realizzazione della MODULAR e della CURVE sono stati studiati per resistere agli agenti atmosferici e per garantire una lunga durata nel tempo: il corpo delle cassette è in alluminio preverniciato, mentre il mantello di rivestimento, la cornice coprifuga e gli sportelli sono realizzati in profilato di alluminio anodizzato o verniciato alle polveri.

## ESTETICA

È possibile scegliere tra molteplici finiture sia per gli sportelli che per il mantello di rivestimento, tra i colori anodizzati o verniciati, richiedendo preventivi personalizzati.

## FUNZIONALITÀ

Tutte le cassette sono dotate di pratico elemento mobile basculante per l'introduzione di posta formato rivista, sono altresì fornite di sportello con serratura per prelevare la posta in modo comodo e veloce.



46

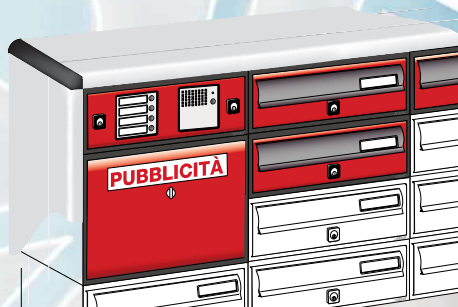
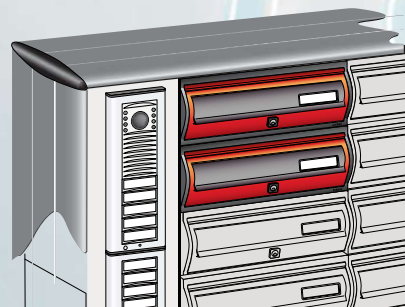
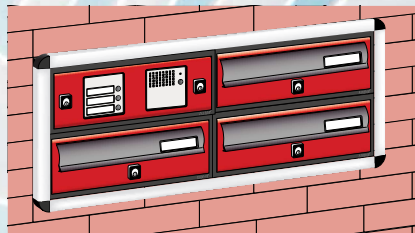
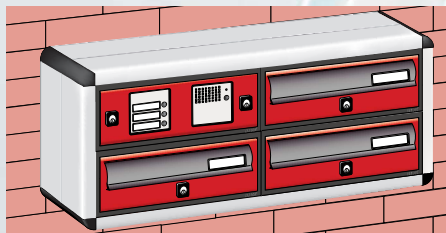
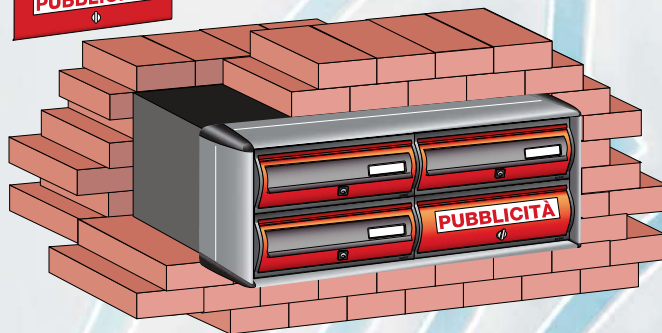
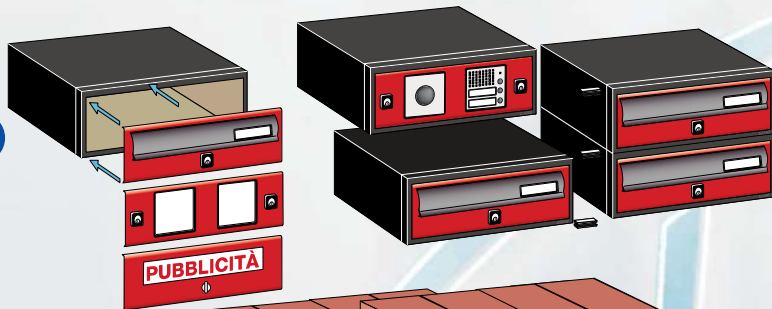



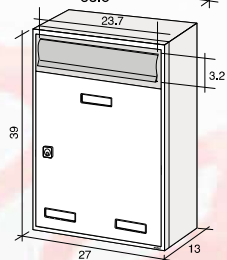
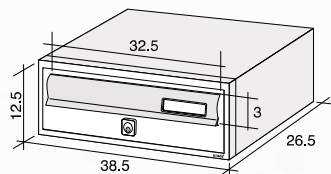
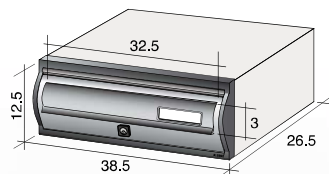

## 1) DIMENSIONI

Le misure minime fanno riferimento al formato EN C4 di 229 x 324 mm.

Alcune misure definite dalle norme EN:

- dimensioni minime della feritoia: 325 x 30 mm
- profondità minima delle cassette verticali: 100 mm
- altezza minima del vano protetto dall'elemento antiprelievo: 40 mm
- dimensioni minime della targhetta portanome: 60x15 mm

## 2) ANTIPRELIEVO

La cassetta deve essere dotata di un dispositivo antiprelievo che, una volta introdotta la corrispondenza, ne ostacoli efficacemente l'estrazione dal vano di introduzione, evitando prelievi da parte di persone non autorizzate. Lamina antiprelievo: 15 mm di profondità e nella lunghezza minima dell'80% della feritoia.

## 3) ROBUSTEZZA

La cassetta deve essere resistente agli agenti atmosferici e deve essere prodotta con lamiera di spessore non inferiore a 1,2 mm. La capacità di resistenza dello sportello deve essere di almeno 15 daN.

*Anche in Italia, l'Ente Poste, con le normative pubblicate il 6/04/2001 sulla Gazzetta Ufficiale, mira a regolamentare la produzione e l'installazione delle cassette postali.*

## CASSETTE DOMICILIARI

Art. 45

### Cassette:

Per la distribuzione degli invii semplici devono essere installate, a spese di chi le posa, cassette accessibili al portalettere. Lo scomparto di deposito, la forma e le dimensioni dell'apertura devono rispondere alle esigenze del traffico postale e risultare tali da consentire di introdurre gli invii senza difficoltà particolari. Le cassette devono recare, ben visibile, l'indicazione del nome dell'intestatario e di chi ne fa uso.

Art. 46

### Ubicazione:

Le cassette devono essere collocate al limite della proprietà, sulla pubblica via o comunque in luogo liberamente accessibile, salvi accordi particolari con l'ufficio postale di distribuzione.

Art. 47

### Edifici plurifamiliari o adibiti ad uso d'impresa:

Negli edifici plurifamiliari, nei complessi formati da più edifici e negli edifici adibiti a sede d'impresa, le cassette delle lettere devono essere raggruppate in un unico punto di accesso.

Art. 48

### Adeguamento delle cassette non conformi

I titolari di cassette non conformi alle specifiche richieste da Poste Italiane provvedono ai necessari adattamenti entro un termine concordato con l'ufficio richiedente.

47



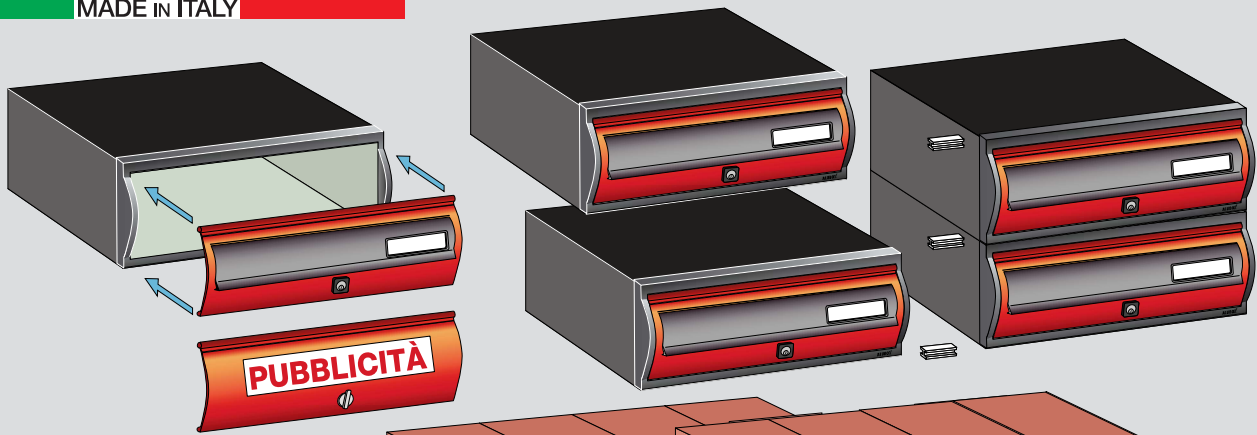

Composizione semincasso con mantello  
Configuration with outer casing  
for semi-recessed mounting

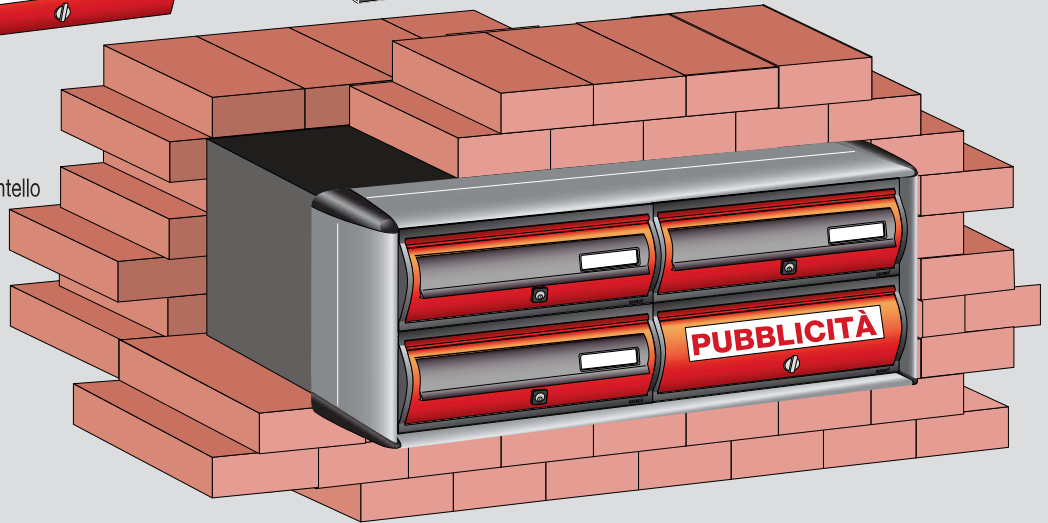

Composizione con mantello per esterni  
Configuration with outer casing  
for outdoors

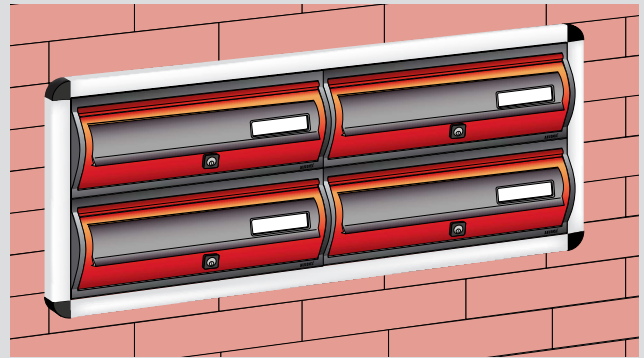
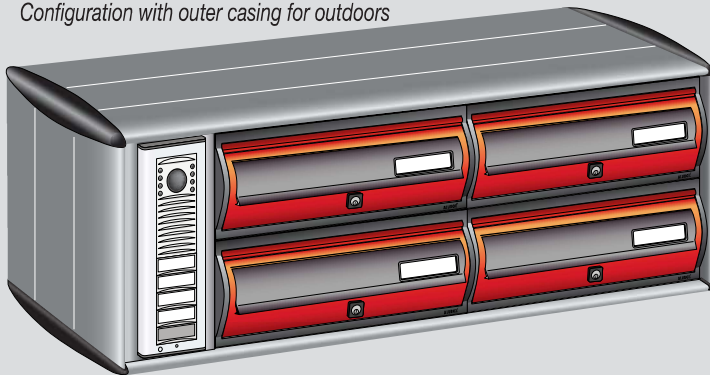

Composizione da incasso con cornice coprifuga  
Configuration for recessed mounting  
with external frame

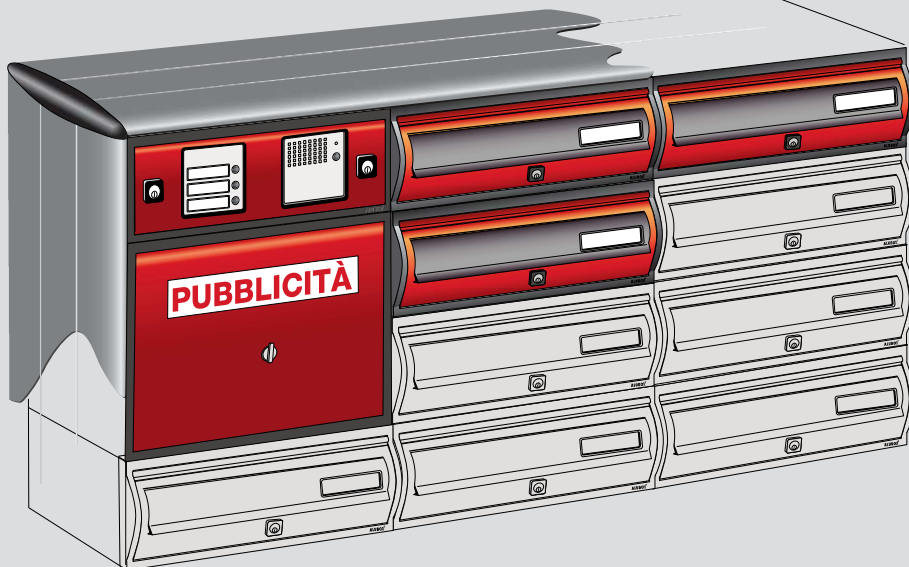

Composizione con mantello, sportello SP1 ACC  
predisposto per l'inserimento di campanelli, tele-  
camera, citofono e numero civico per i modelli Bti-  
cino Sfera e corpo doppio pubblicità.  
Accessori vedi da pag. 71.

Example of configuration with outer casing, com-  
posed to SP1 ACC door suitable for door bells vi-  
deocamera intercom, residence number for Bti-  
cino Sfera brand and double box for advertising.  
Accessories, see page 71.



MADE IN ITALY



Esempio cassetta Curve 1: Corpo (C1) + Sportello (SP1)  
Example of Curve 1 mailbox: Body (C1) + Door (SP1)



CURVE C1 CGH  
con cornice di plastica ghisa  
with cast-iron grey plastic frame



CURVE C1 CAR  
con cornice di plastica argento  
with silver plastic frame



CURVE C1 CBI  
con cornice di plastica bianca  
with white plastic frame

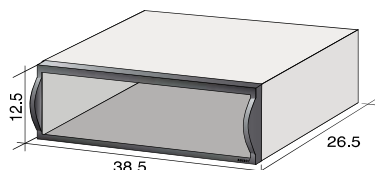

CURVE C1

(confezione da 6 pezzi)

## CORPO SERIE CURVE 1 PRELIEVO FRONTALE

- C1 • Corpo per cassetta componibile in **alluminio**
- C1F • Corpo per cassetta componibile in **lamiera elettrozincata**

(6-pieces package)

## CURVE SERIES 1 BODY FRONT ACCESS

- C1 • Body for modular mailbox - **aluminium**
- C1F • Body for modular mailbox - **electrogalvanized sheet steel**

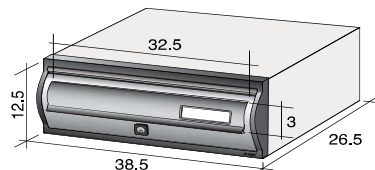

CURVE 1 completa - CURVE 1 complete box



CURVESP1AR



CURVESP1GH



CURVESP1RO / el. mob. GH



CURVESP1VE / el. mob. GH



CURVESP1BI



CURVESP1GH / el. mob. ARMET



CURVESP1RUG



CURVESP1ARMET



CURVESP1ARMET / el. mob. GH



CURVESP1PUB  
con kit pubblicità (vedi pag. 34)  
with publicity kit (see page 34)

(confezione 6 pezzi)

## SPORTELLO Curve SP1

Sportello per corpo Curve 1 completo  
di elemento mobile in profilato d'alluminio:

- anodizzato argento
- verniciato ghisa
- verniciato rosso RAL 3003 con elemento mobile ghisa
- verniciato verde RAL 6005 con elemento mobile ghisa
- verniciato bianco RAL 9016
- verniciato ghisa con elemento mobile metallizzato argento
- verniciato ruggine
- verniciato metallizzato argento
- verniciato metallizzato argento con elemento mobile ghisa
- con Kit Pubblicità

Tutta la Serie Curve viene fornita con corpo e sportelli smontati.

(6-pieces package)

## Curve SP1 DOOR

Aluminium profile door for Curve 1 body,  
complete with flap:

- anodized - silver
- painted in cast-iron grey
- painted in RAL 3003 red, with cast-iron grey flap
- painted in RAL 6005 green, with cast-iron grey flap
- painted in RAL 9016 white
- painted in cast-iron grey, with metallic silver flap
- painted in rust
- painted in metallic silver
- painted in metallic silver, with cast-iron grey flap
- with publicity kit

CURVE series mailboxes are supplied in loose form ready for assembly.

49

COLORI RAL A RICHIESTA  
SENZA SUPPLEMENTO DI PREZZO

RAL COLORS ON REQUEST  
WITHOUT ADDITIONAL CHARGE

★ Previa disponibilità presso verniciatura.  
Subject to availability at varnisher.



(confezione da 1 pezzo)

## CORPO DOPPIO con sportello pubblicità.

(1-piece package)

## DOUBLE HEIGHT BOX with publicity door.

Anche nelle composizioni della Serie CURVE 1 è possibile inserire un corpo doppio con sportello pubblicità.

It's possible to supply double height box for publicity also for CURVE 1 Series.



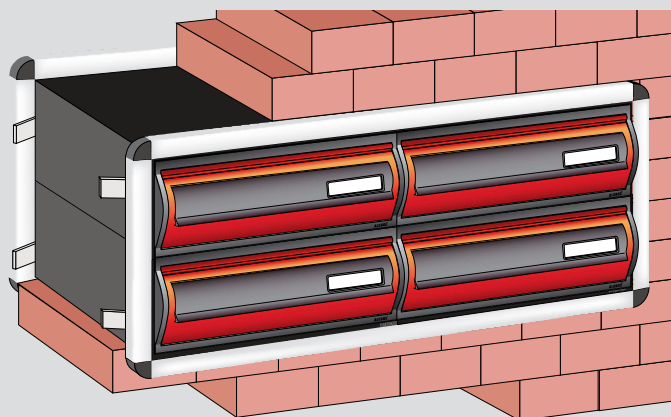
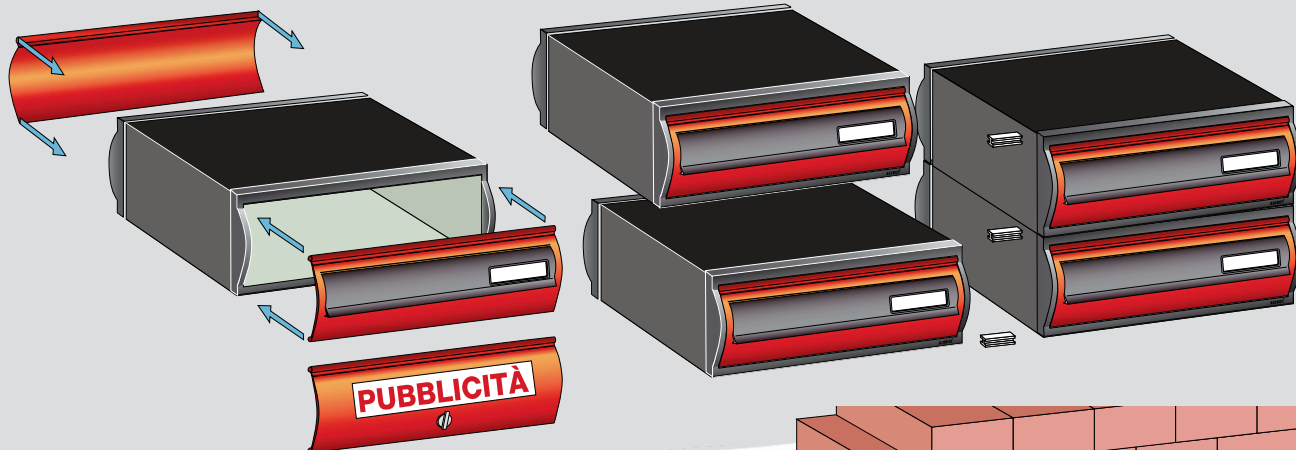

50

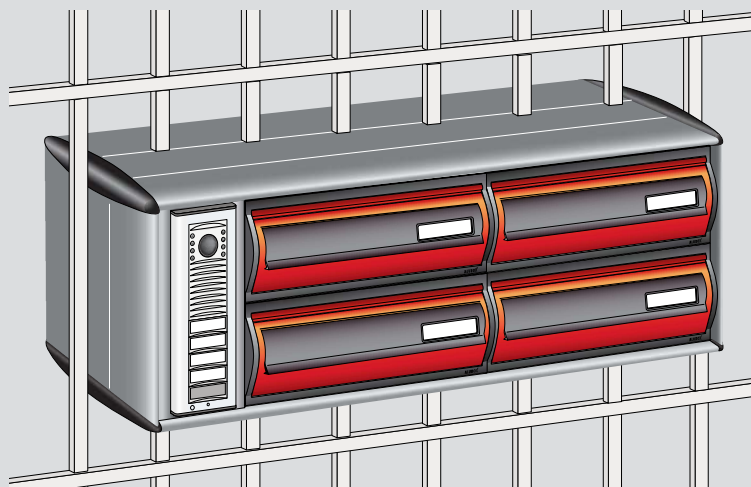

Composizione da incasso con doppia cornice  
Configuration for recessed mounting with double external frame

Composizione con mantello da recinzione  
Configuration with outer casing for fence mounting

Composizione con mantello, sportello SP1 ACC predisposto per l'inserimento di campanelli, telecamera, citofono e numero civico per i modelli Bticino Sfera e corpo doppio pubblicità. Accessori vedi da pag. 71.

Example of configuration with outer casing, composed to SP1 ACC door suitable for door bells videocamera intercom, residence number for Bticino Sfera brand and double box for advertising. Accessories, see page 71.

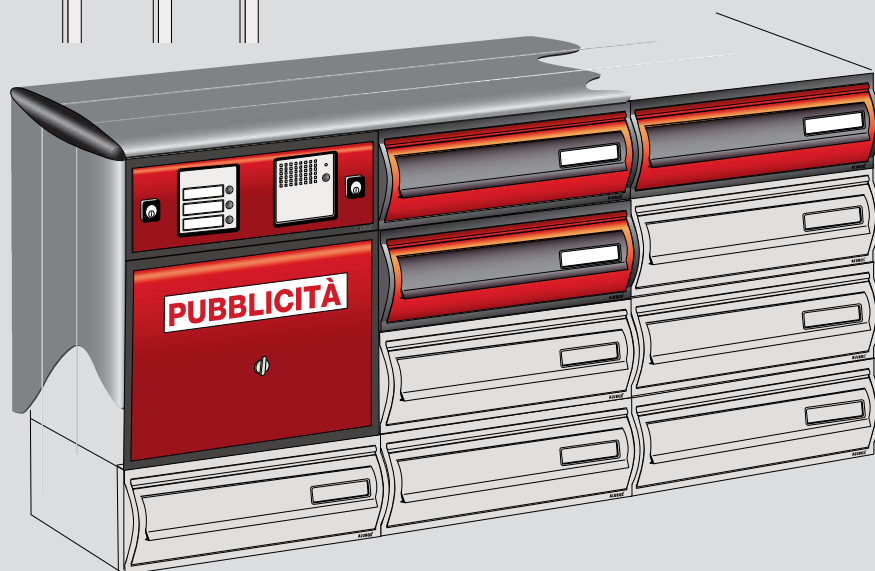



Esempio cassetta Curve 2: Corpo (C2) + Sportello (SP2F)  
Example of Curve 2 mailbox: Body (C2) + Door (SP2F)



CURVE C2 CGH  
con cornice di plastica ghisa  
with cast-iron grey plastic frame



CURVE C2 CAR  
con cornice di plastica argento  
with silver plastic frame



CURVE C2 CBI  
con cornice di plastica bianca  
with white plastic frame

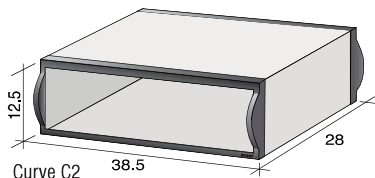

Curve C2

(confezione da 6 pezzi)

### CORPO SERIE CURVE 2 PRELIEVO POSTERIORE

- C2 • Corpo per cassetta componibile in **alluminio**
- C2F • Corpo per cassetta componibile in **lamiera elettrozincata**

(6-pieces package)

### CURVE SERIES 2 BODY REAR ACCESS

- C2 • Body for modular mailbox - **aluminium**
- C2F • Body for modular mailbox - **electrogalvanized sheet steel**

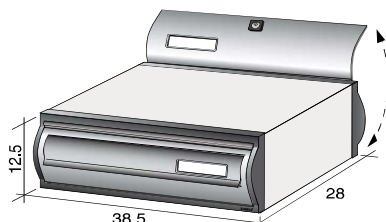

CURVE 2 completa - CURVE 2 complete box



CURVESP2FAR



CURVESP2FGH



CURVESP2FR0 / el. mob. GH



CURVESP2FVE / el. mob. GH



CURVESP2FBI



CURVESP2FGH / el. mob. ARMET

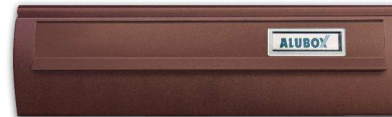

CURVESP2FRUG



CURVESP2FARMET



CURVESP2FARMET / el. mob. GH



CURVESP1PUB  
con kit pubblicità (vedi pag. 34)  
with publicity kit (see page 34)



CURVESP2F  
Fronte / Front view



CURVESP2R  
Retro / Rear view

(confezione 6 pezzi)

### SPORTELLLO CURVE SP2F

Sportello frontale per serie Curve 2, completo di elemento mobile, in profilato d'alluminio:

- anodizzato argento
- verniciato ghisa
- verniciato rosso RAL 3003 con elemento mobile ghisa
- verniciato verde RAL 6005 con elemento mobile ghisa
- verniciato bianco RAL 9016
- verniciato ghisa con elemento mobile metallizzato argento
- verniciato ruggine
- verniciato metallizzato argento
- verniciato metallizzato argento con elemento mobile ghisa
- con Kit Pubblicità

### Sportello Curve SP2R

- Sportello Curve SP2R retro per Curve 2, finiture come per SP2F, completo di serratura

Tutta la Serie CURVE viene fornita con corpo e sportelli smontati.

(6-pieces package)

### Curve SP2F DOOR

Aluminium profile front door for Curve 2 series, complete with flap:

- anodized - silver
- painted in cast-iron grey
- painted in RAL 3003 red, with cast-iron grey flap
- painted in RAL 6005 green, with cast-iron grey flap
- painted in RAL 9016 white
- painted in cast-iron grey, with metallic silver flap
- painted in rust
- painted in metallic silver
- painted in metallic silver, with cast-iron grey flap
- with publicity kit

### Curve SP2R Door

- Rear door Curve SP2R for Curve 2. Same finishes as SP2F, complete with lock

CURVE series mailboxes are supplied in loose form ready for assembly.

COLORI RAL A RICHIESTA  
SENZA SUPPLEMENTO DI PREZZO

RAL COLORS ON REQUEST  
WITHOUT ADDITIONAL CHARGE

★ Previa disponibilità presso verniciatura.  
Subject to availability at varnisher.



(confezione da 1 pezzo)

CORPO DOPPIO con sportello pubblicità.

(1-piece package)

DOUBLE HEIGHT BOX with publicity door.

Anche nelle composizioni della Serie CURVE 2 è possibile inserire un corpo doppio con sportello pubblicità.

It's possible to supply double height box for publicity also for CURVE 2 Series.

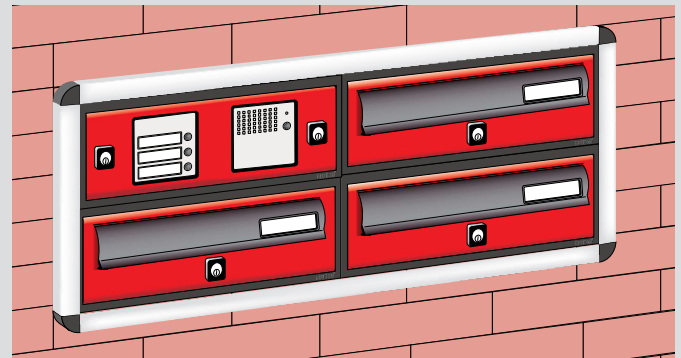
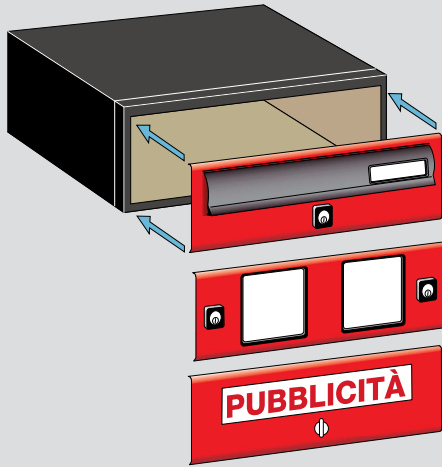

52

Composizione con mantello per esterni  
Configuration with outer casing for outdoors

Composizione da incasso con cornice coprifuga  
Configuration for recessed mounting with external frame

Composizione semincasso con mantello  
Configuration with outer casing for semi-recessed mounting

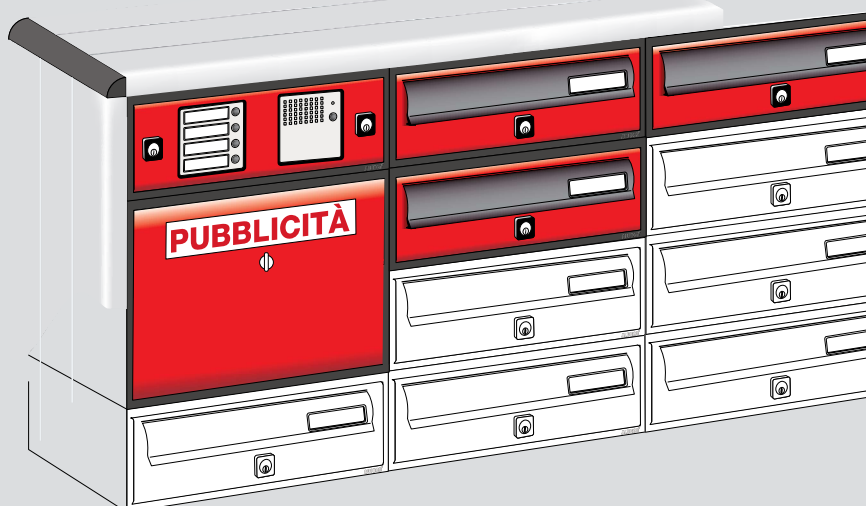
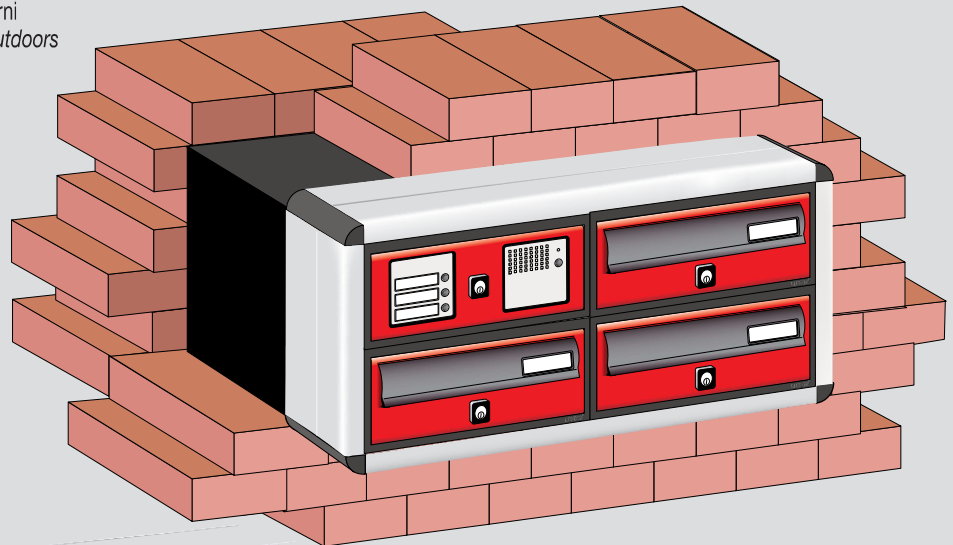

Composizione con mantello, sportello SP1 ACC predisposto per l'inserimento di campanelli, telecamera, citofono e numero civico per i modelli Bticino Sfera e corpo doppio pubblicità. Accessori vedi da pag. 71.

Example of configuration with outer casing, composed to SP1 ACC door suitable for door bells videocamera intercom, residence number for Bticino Sfera brand and double box for advertising. Accessories, see page 71.





Esempio cassetta Modular 1: Corpo (C1) + Sportello (SP1)  
Example of Modular 1 mailbox: Body (C1) + Door (SP1)



Modular C1 CGH  
con cornice di plastica ghisa  
with cast-iron grey plastic frame



Modular C1 CAR  
con cornice di plastica argento  
with silver plastic frame



Modular C1 CBI  
con cornice di plastica bianca  
with white plastic frame

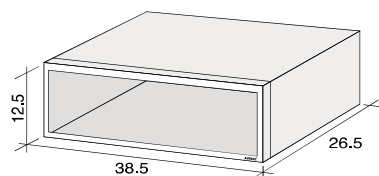

Modular C1

(confezione da 6 pezzi)

### CORPO MODULAR 1 PRELIEVO FRONTALE

- C1** • Corpo per cassetta componibile in **alluminio**
- C1F** • Corpo per cassetta componibile in **lamiera elettrozincata**

(6-pieces package)

### MODULAR 1 BODY FRONT ACCESS

- C1** • Body for modular mailbox - **aluminium**
- C1F** • Body for modular mailbox - **electrogalvanized sheet steel**

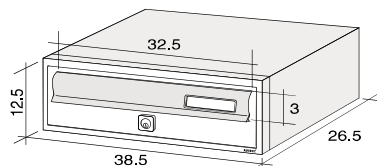

Modular 1 completa  
Modular 1 complete box



SP1AR



SP1BR



SP1RO / el. mob. ghisa



SP1VE / el. mob. ghisa



SP1BI



SP1GH



SP10TT con elemento mobile in ottone  
SP10TT with polished brass flap



SP1PUB con kit pubblicità (vedi pag. 34)  
SP1PUB with publicity kit (see page 34)

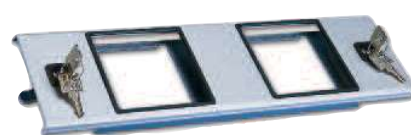

### SPORTELLLO SP1 ACC

Sportello Serie MODULAR in profilato d'alluminio predisposto per l'inserimento di campanelli, telecamera, citofono e numero civico per i modelli Bticino Sfera. Accessori vedi da pag. 71. **Finiture: vedi SP1**

### SP1 ACC DOOR

MODULAR series panel in aluminium profile designed for incorporating doorbells, video camera, intercom and residence number for models Bticino Sfera. Accessories, see from page 71. **Types of finish: see SP1**



### AM1

Kit antivandalo con chiusura in tre punti per modello SP1.

### AM1

Anti-vandal kit with three-point lock for SP1 door.

(confezione 6 pezzi)

### SPORTELLLO Modular SP1

Sportello per Modular 1, completo di elemento mobile, in profilato d'alluminio:

- anodizzato argento
- anodizzato bronzo
- verniciato rosso RAL 3003 con elemento mobile ghisa
- verniciato verde RAL 6005 con elemento mobile ghisa
- verniciato bianco RAL 9016
- verniciato ghisa
- verniciato ghisa con elemento mobile in ottone
- con Kit Pubblicità

Tutta la Serie MODULAR viene fornita con corpo e sportelli smontati.

(6-pieces package)

### DOOR MODULAR SP1

Aluminium profile universal door for Modular 1 body, complete with flap:

- anodized - silver
- anodized - bronze
- painted in RAL 3003 red, with cast-iron grey flap
- painted in RAL 6005 green, with cast-iron grey flap
- painted in RAL 9016 white
- painted in cast-iron
- painted in cast-iron grey with brass flap
- with publicity kit

MODULAR series mailboxes are supplied in loose form ready for assembly.



(confezione da 1 pezzo)

**CORPO DOPPIO** con sportello pubblicità.

(1-piece package)

**DOUBLE HEIGHT BOX** with publicity door.

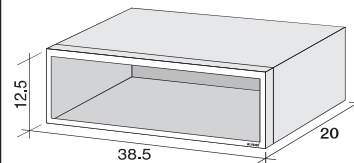

Modular 2001

**C2001** • Corpo per cassetta componibile in alluminio con profondità 20 cm.  
**SOLO DA INCASSO CON CORNICE**  
**NON CONFORME ALLE NORMATIVE EN 13724**

**C2001** • Body for modular mailbox aluminium with 20 cms depth.  
**ONLY FOR RECESS MOUNTING WITH EXTERNAL FRAME.**  
**NOT IN ACCORDANCE WITH EUROPEAN STANDARD RULES EN 13724**

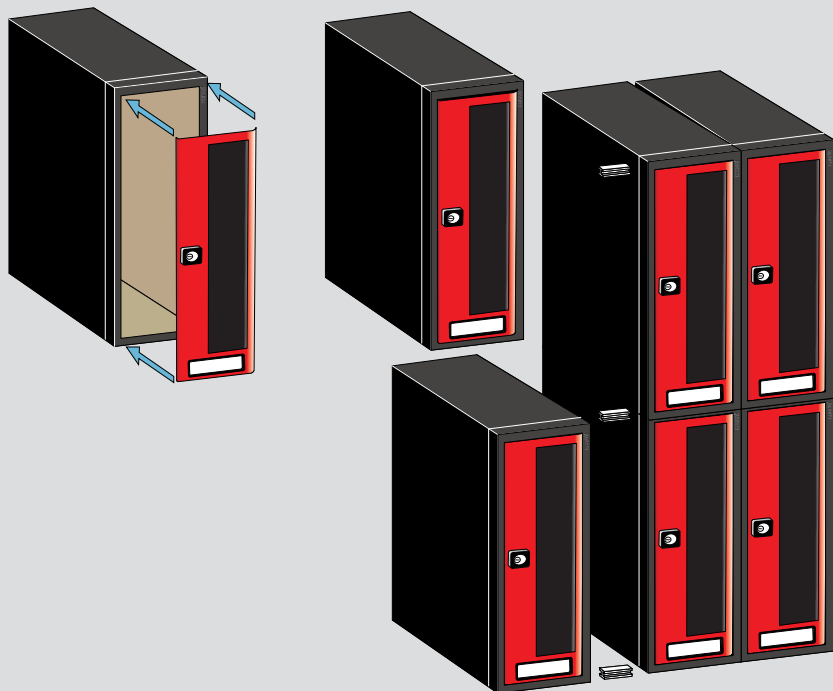

Composizione con mantello  
Configuration with outer casing

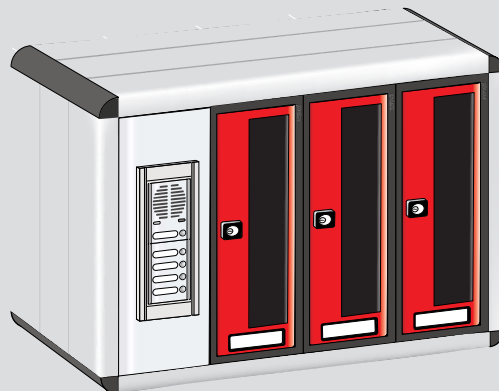

Composizione incasso con cornice coprifuga  
Configuration for recessed mounting with external frame

54

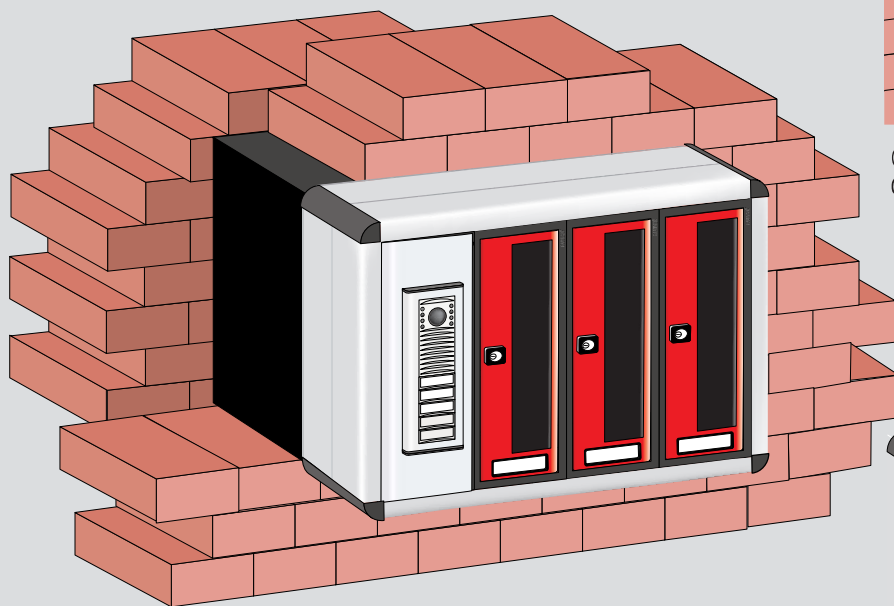

Composizione semincasso con mantello  
Configuration with outer casing for semi-recessed mounting





MADE IN ITALY

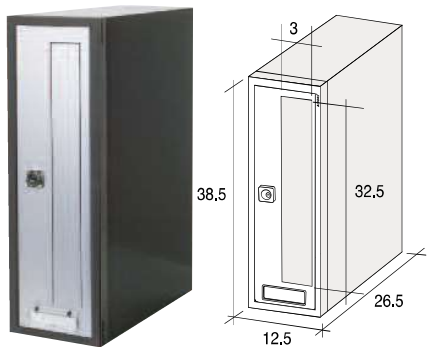

Esempio cassetta Modular 1V:  
Corpo (C1) + Sportello (SP1V)

Modular 1V completa  
Modular 1V complete box

Example of Modular 1V mailbox:  
Body (C1) + Door (SP1V)



(confezione 6 pezzi)

### SPORTELLLO Modular SP1V

Sportello per Modular 1 verticale completo di elemento mobile, in profilato d'alluminio:

- anodizzato argento
- anodizzato bronzo
- verniciato rosso RAL 3003 con elemento mobile ghisa
- verniciato verde RAL 6005 con elemento mobile ghisa
- verniciato bianco RAL 9016
- verniciato ghisa

Tutta la Serie MODULAR viene fornita con corpo e sportelli smontati.

(6-pieces package)

### MODULAR SP1V DOOR

Aluminium profile door for vertical Modular 1, complete with flap:

- anodized - silver
- anodized - bronze
- painted in RAL 3003 red, with cast-iron grey flap
- painted in RAL 6005 green, with cast-iron grey flap
- painted in RAL 9016 white
- painted in cast-iron grey

MODULAR series mailboxes are supplied in loose form ready for assembly.

55



Modular C1 CGH  
con cornice di plastica ghisa  
with cast-iron grey plastic  
frame

Modular C1 CAR  
con cornice di plastica argento  
with silver plastic frame



SP1VVE  
el. mob. ghisa

SP1VBI

SP1VGH

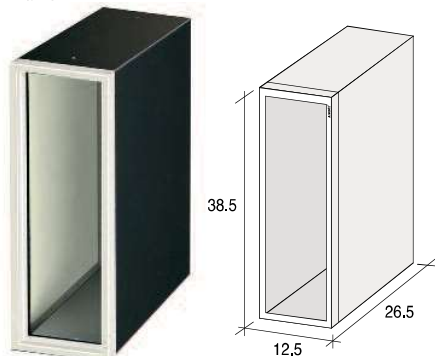

Modular C1 CBI  
con cornice di plastica bianca  
with white plastic frame

(confezione da 6 pezzi)

### CORPO MODULAR 1 PRELIEVO FRONTALE

- C1 • Corpo per cassetta componibile in alluminio
- C1F • Corpo per cassetta componibile in lamiera elettrozincata

(6-pieces package)

### MODULAR 1 BODY FRONT ACCESS

- C1 • Body for modular mailbox - aluminium
- C1F • Body for modular mailbox - electrogalvanized sheet steel

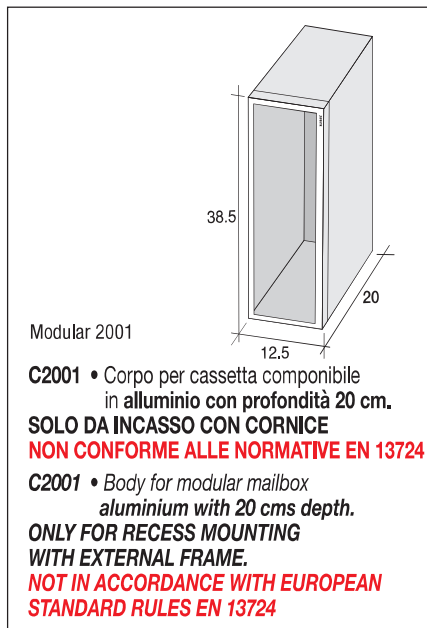

Modular 2001

- C2001 • Corpo per cassetta componibile in alluminio con profondità 20 cm.

**SOLO DA INCASSO CON CORNICE  
NON CONFORME ALLE NORMATIVE EN 13724**

**C2001 • Body for modular mailbox  
aluminium with 20 cms depth.  
ONLY FOR RECESS MOUNTING  
WITH EXTERNAL FRAME.  
NOT IN ACCORDANCE WITH EUROPEAN  
STANDARD RULES EN 13724**

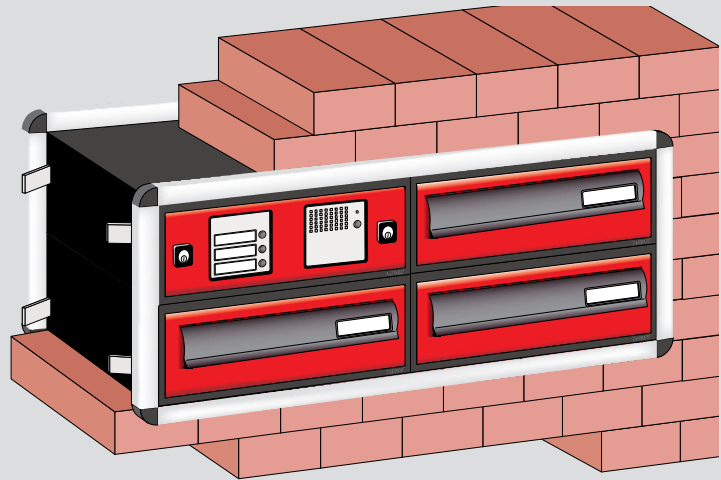
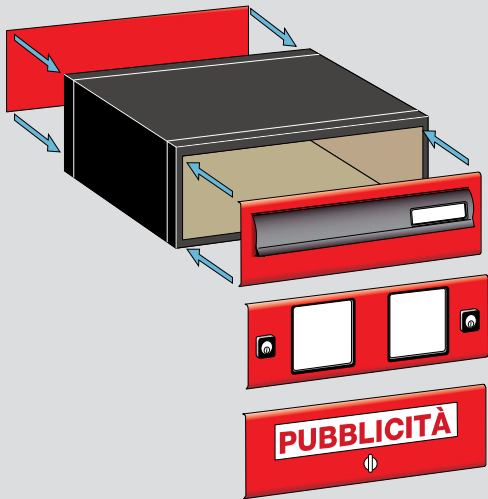

56

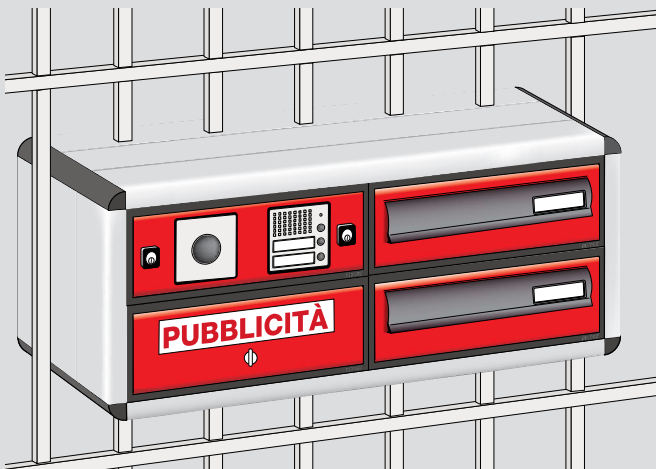

Composizione da incasso con doppia cornice  
Configuration for recessed mounting with double external frame

Composizione con mantello da recinzione  
Configuration with outer casing for fence mounting

Composizione con mantello, sportello SP1 ACC predisposto per l'inserimento di campanelli, telecamera, citofono e numero civico per i modelli Bticino Sfera e corpo doppio pubblicità. Accessori vedi da pag. 71.

Example of configuration with outer casing, composed to SP1 ACC door suitable for door bells videocamera intercom, residence number for Bticino Sfera brand and double box for advertising. Accessories, see page 71.

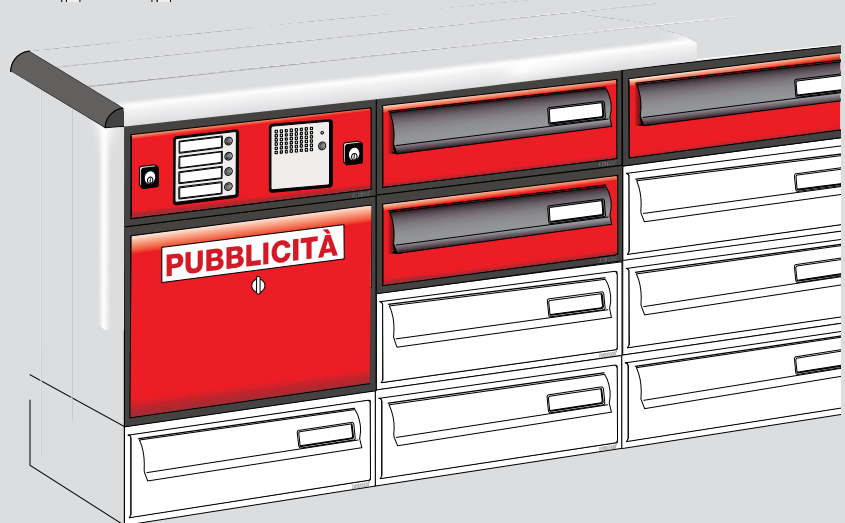



MADE IN ITALY



Esempio cassetta Modular 2: Corpo (C2) + Sportello (SP2F)  
Example of Modular 2 mailbox: Body (C2) + Door (SP2F)



Modular C2 CGH  
con cornice di plastica ghisa  
with cast-iron grey plastic frame



Modular C2 CAR  
con cornice di plastica argento  
with silver plastic frame



Modular C2 CBI  
con cornice di plastica bianca  
with white plastic frame

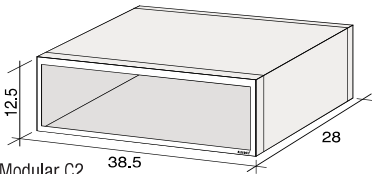

Modular C2

(confezione da 6 pezzi)

### CORPO MODULAR C2 PRELIEVO POSTERIORE

- C2** • Corpo per cassetta componibile bifrontale in **alluminio**
- C2F** • Corpo per cassetta componibile bifrontale in **lamiera elettrozincata**

(6-pieces package)

### MODULAR C2 BODY REAR ACCESS

- C2** • Body for double-sided modular mailbox - **aluminium**
- C2F** • Body for double-sided modular mailbox - **electrogalvanized sheet steel**

Modular 2 completa  
Modular 2 complete box

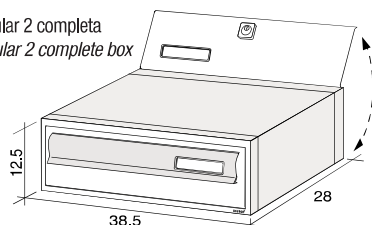

SP2FAR



SP2FBR



SP2FRO / el. mob. ghisa



SP2FVE / el. mob. ghisa



SP2FBI



SP2FGH



SP20TT con elemento mobile in ottone  
SP20TT with polished brass flap



SP1PUB con kit pubblicità (vedi pag. 34)  
SP1PUB with publicity kit (see page 34)



### MODULAR 2 ACC

Cassetta completa bifrontale da incasso passante, in alluminio elettro colore testa di moro e sportello porta accessori predisposto per l'inserimento di campanelli, telecamera, citofono e numero civico per i modelli Bticino Sfera. Accessori vedi da pag. 71.

### MODULAR 2 ACC

Complete through mounting double-sided mailbox, in dark brown oxi-anodized aluminium and accessories panel designed for incorporating doorbells, video camera, intercom and residence number for models Bticino Sfera. Accessories, see from page 71.



### AM1

Kit antivandalo con chiusura a tre punti per modello SP2R.

### AM1

Anti-vandal kit with three-point lock for SP2R door.

(confezione 6 pezzi)

### SPORTELLLO Modular SP2F

Sportello frontale per Modular 2, completo di elemento mobile, in profilato d'alluminio:

- anodizzato argento
- anodizzato bronzo
- verniciato rosso RAL 3003 con elemento mobile ghisa
- verniciato verde RAL 6005 con elemento mobile ghisa
- verniciato bianco RAL 9016
- verniciato ghisa
- verniciato ghisa con elemento mobile in ottone
- con Kit Pubblicità

### Sportello Modular SP2R

- Sportello Modular SP2R retro, per Modular 2, finiture come per SP2F, completa di serratura

Tutta la Serie MODULAR viene fornita con corpo e sportelli smontati.

(6-pieces package)

### MODULAR SP2F DOOR

Aluminium profile front door for Modular 2, complete with flap:

- anodized - silver
- anodized - bronze
- painted in RAL 3003 red, with cast-iron grey flap
- painted in RAL 6005 green, with cast-iron grey flap
- painted in RAL 9016 white
- painted in cast-iron grey
- painted in cast-iron grey with brass flap
- with publicity kit

### Modular SP2R Door

- Rear door Modular SP2R for Modular 2. Same finishes as SP2F, complete with lock

MODULAR series mailboxes are supplied in loose form ready for assembly.

57



SP2F  
Fronte  
Front view



SP2R  
Retro  
Rear view



(confezione da 1 pezzo)

### CORPO DOPPIO con sportello pubblicità.

(1-piece package)

DOUBLE HEIGHT BOX with publicity door.

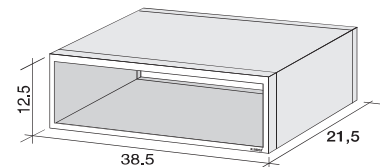

Modular 2002

**C2002** • Corpo per cassetta componibile in alluminio con profondità 21,5 cm.  
**SOLO DA INCASSO CON CORNICE  
NON CONFORME ALLE NORMATIVE EN 13724**

**C2002** • Body for modular mailbox aluminium with 21.5 cms depth.  
**ONLY FOR RECESS MOUNTING  
WITH EXTERNAL FRAME.  
NOT IN ACCORDANCE WITH EUROPEAN  
STANDARD RULES EN 13724**

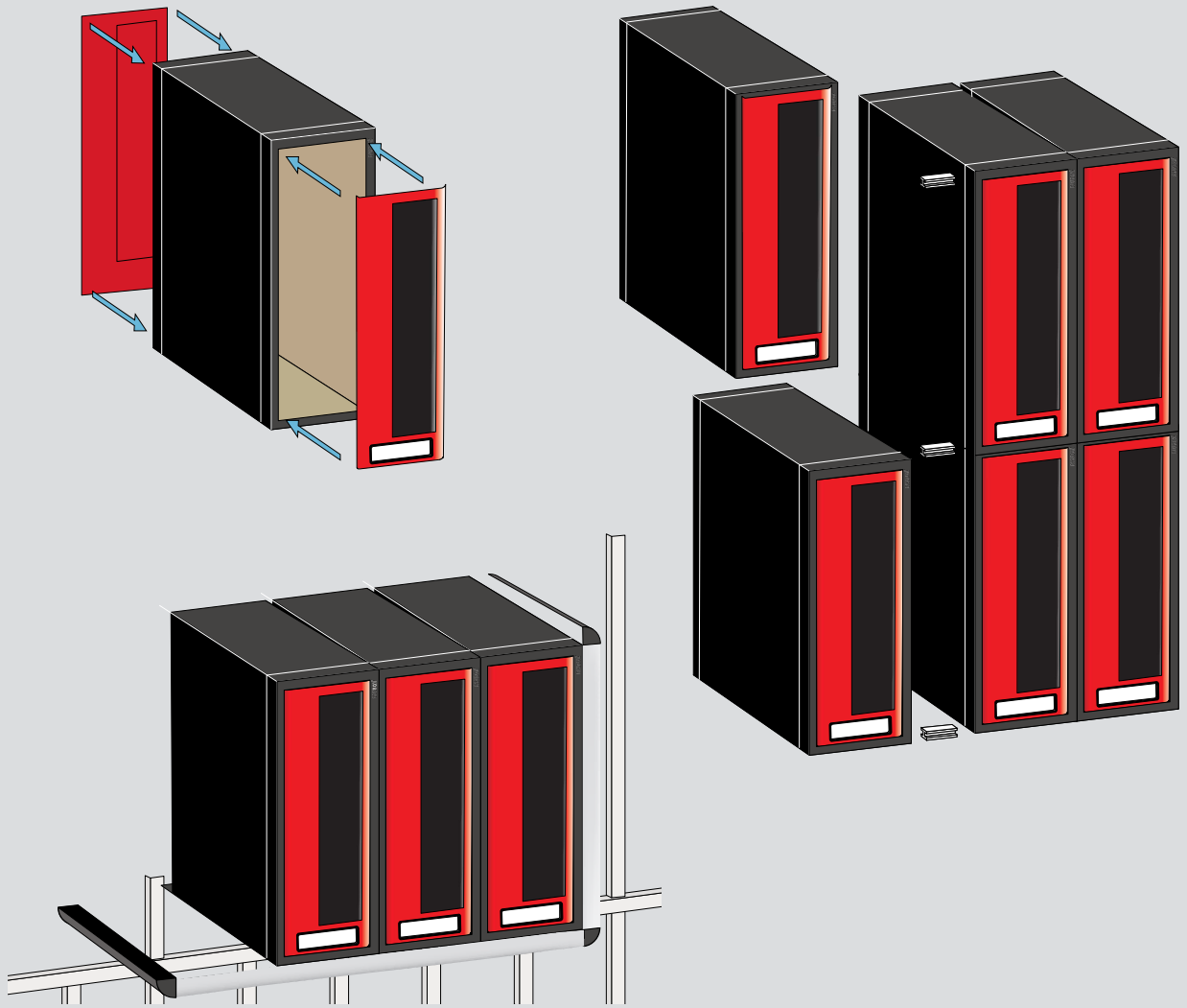

MADE IN ITALY

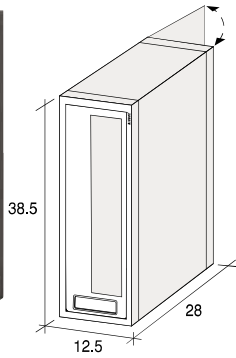

Esempio cassetta Modular 2V:  
Corpo (C2) + Sportello (SP2F)  
Example of Modular 2V mailbox:  
Body (C2) + Door (SP2F)

Modular 2V completa  
Modular 2V complete box



Modular C2 CGH  
con cornice di plastica ghisa  
with cast-iron grey plastic  
frame



Modular C2 CAR  
con cornice di plastica argento  
with silver plastic frame



Modular C2 CBI  
con cornice di plastica bianca  
with white plastic frame

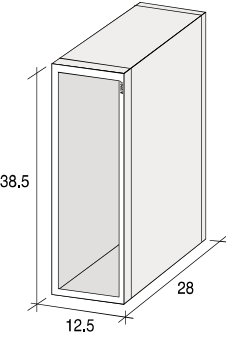

Modular C2

(confezione da 6 pezzi)

### CORPO MODULAR 2 PRELIEVO POSTERIORE

- C2** • Corpo per cassetta componibile bifrontale in **alluminio**
- C2F** • Corpo per cassetta componibile bifrontale in **lamiera elettrozincata**

(6-pieces package)

### MODULAR 2 BODY REAR ACCESS

- C2** • Body for double-sided through mounting modular mailbox - **aluminium**
- C2F** • Body for double-sided through mounting modular mailbox - **electrogalvanized sheet steel**



SP2VFAR



SP2VFBR



SP2VFR0  
el. mob. ghisa

(confezione 6 pezzi)

### SPORTELLLO Modular SP2VF

Sportello frontale per Modular 2 verticale, completo di elemento mobile, in profilato d'alluminio:

- anodizzato argento
- anodizzato bronzo
- verniciato rosso RAL 3003 con elemento mobile ghisa
- verniciato verde RAL 6005 con elemento mobile ghisa
- verniciato bianco RAL 9016
- verniciato ghisa

### Sportello Modular SP2VR

- Sportello Modular SP2VR retro, per Modular 2, finiture come per SP2VF, completa di serratura

Tutta la Serie MODULAR viene fornita con corpo e sportelli smontati.

(6-pieces package)

### MODULAR SP2VF DOOR

Aluminium profile front door for vertical Modular 2, complete with flap:

- anodized - silver
- anodized - bronze
- painted in RAL 3003 red, with cast-iron grey flap
- painted in RAL 6005 green, with cast-iron grey flap
- painted in RAL 9016 white
- painted in cast-iron grey

### Modular SP2VR Door

- Rear door Modular SP2VR for Modular 2. Same finishes as SP2F, complete with lock

MODULAR series mailboxes are supplied in loose form ready for assembly.



SP2VFVE  
el. mob. ghisa



SP2VFB1



SP2VFGH

59



SP2VF

Fronte - Front view



SP2VR

Retro - Rear view

Modular 2002

**C2002** • Corpo per cassetta componibile in **alluminio** con profondità 21,5 cm.  
**SOLO DA INCASSO CON CORNICE**  
**NON CONFORME ALLE NORMATIVE EN 13724**

**C2002** • Body for modular mailbox **aluminium** with 21.5 cms depth.  
**ONLY FOR RECESS MOUNTING WITH EXTERNAL FRAME.**  
**NOT IN ACCORDANCE WITH EUROPEAN STANDARD RULES EN 13724**



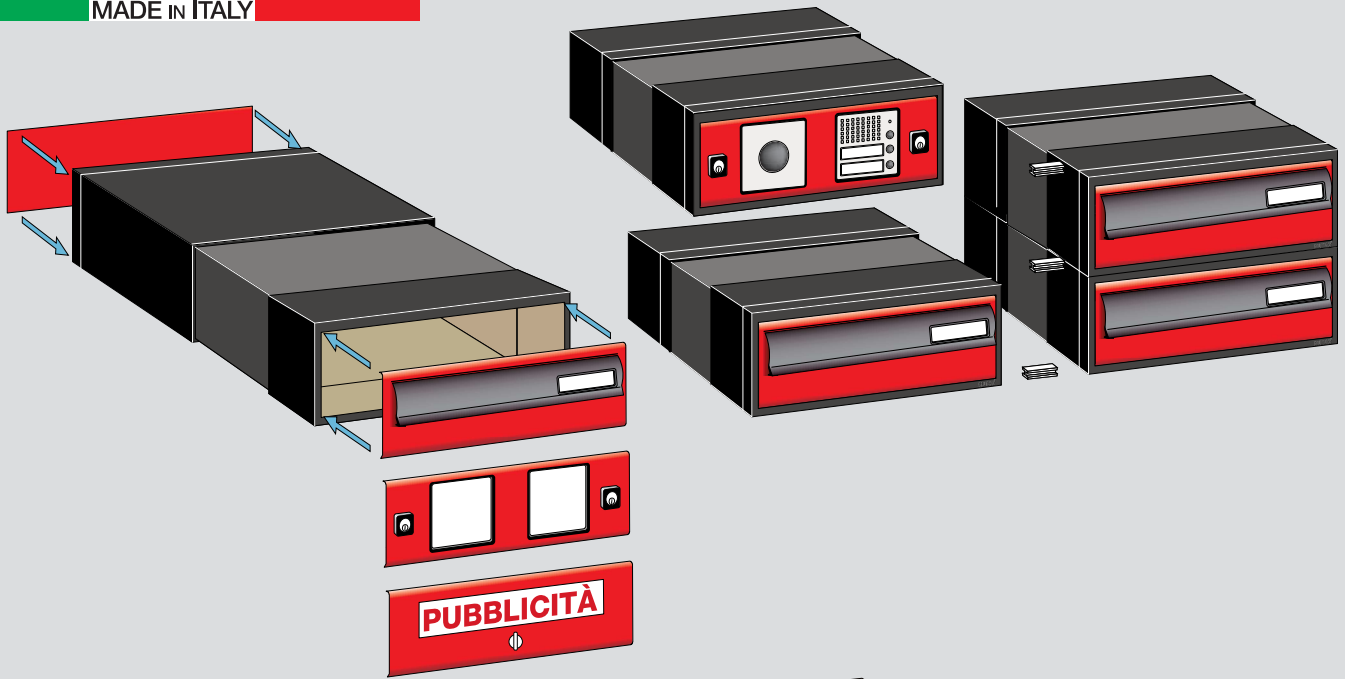

60

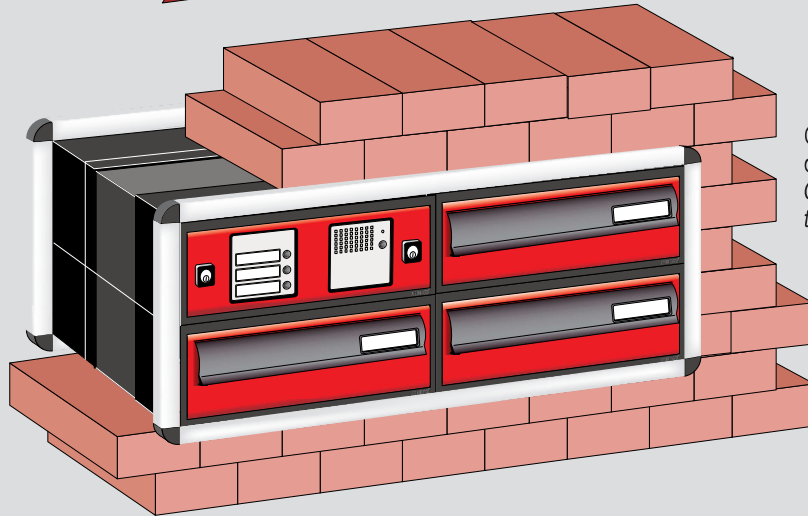

Composizione da incasso con  
doppia cornice coprifuga  
Configuration for recessed moun-  
ting with double external frame

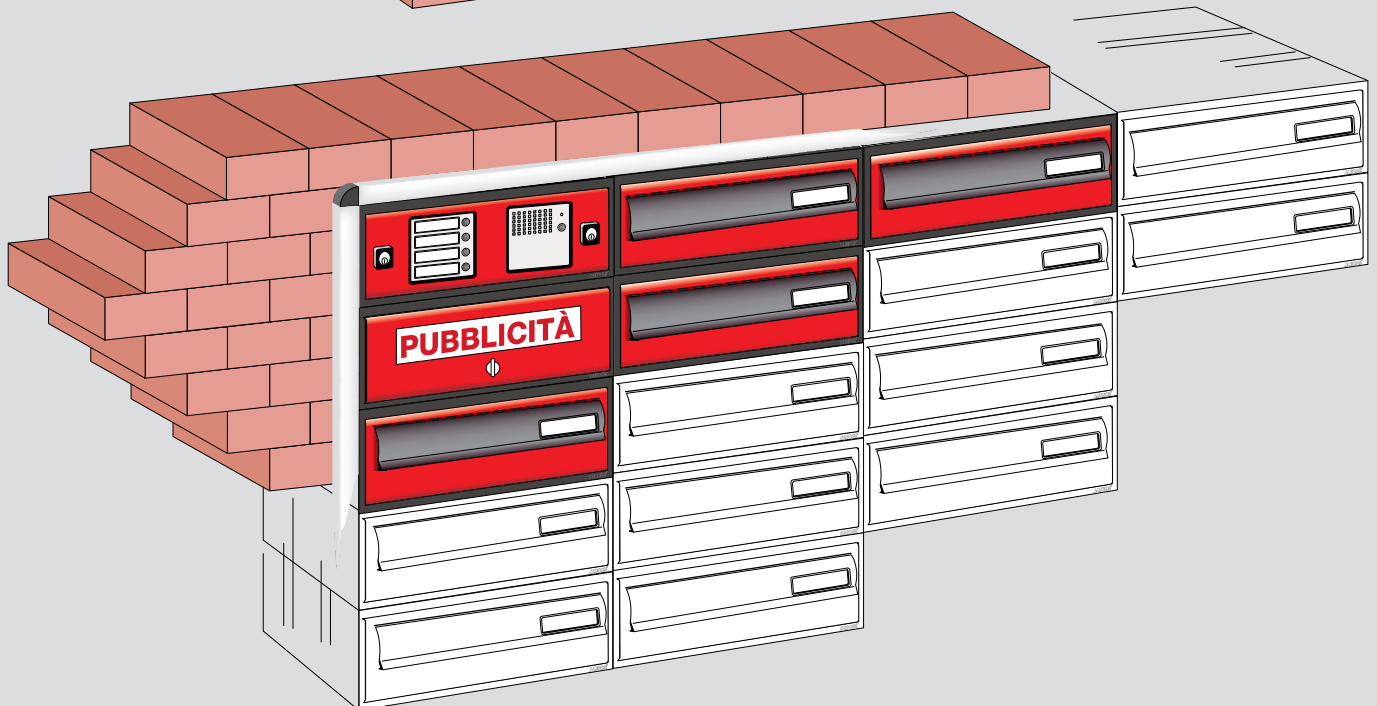



Modular 2 T CGH completa con cornice di plastica ghisa  
*Modular 2 T CGH complete box with cast-iron grey plastic frame*



Modular 2 T CAR completa con cornice di plastica argento  
*Modular 2 T CAR complete box with silver plastic frame*



Modular 2 T CBI completa con cornice di plastica bianca  
*Modular 2 T CBI complete box with white plastic frame*

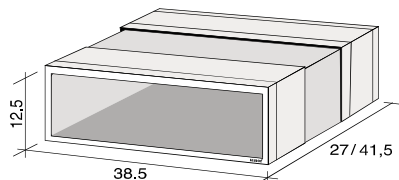

(confezione da 6 pezzi)

**CORPO MODULAR 2T  
PRELIEVO POSTERIORE**

**C2T** • Corpo per cassetta componibile bifrontale in lamiera elettrozincata

(6-pieces package)

**MODULAR 2T BODY  
REAR ACCESS**

**C2T** • Body for double-sided through mounting modular mailbox - **electrogalvanized sheet steel**

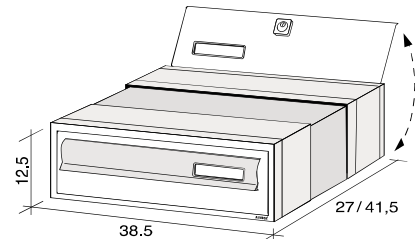

Modular 2 T completa - *Modular 2 T complete box*

**Modular Telescopica:**  
cassetta bifrontale da incasso con corpo a profondità variabile: da un minimo di cm 27,5 a un massimo di cm 43 di spessore del muro.

**Disponibile anche la versione VERTICALE (SP vedi pag 59)**

**Modular Telescopica:**  
two-sided recessed mounted mail box with body of varying depth suitable for a wall depth ranging from 27.5 cm to 43 cm.

**Also available in VERTICAL edition (please see pag 59 for doors)**



SP2FAR



SP2FBR



SP2FRO / el. mob. ghisa



SP2FVE / el. mob. ghisa



SP2FBI



SP2FGH



SP2OTT con elemento mobile in ottone  
*SP2OTT with polished brass flap*



SP1PUB con kit pubblicità (vedi pag. 34)  
*SP1PUB with publicity kit (see page 34)*



**MODULAR 2 ACC**

Cassetta completa bifrontale da incasso passante, in lamiera elettrozincata e sportello porta accessori predisposto per l'inserimento di campanelli, telecamera, citofono e numero civico per i modelli Biticino Sfera. Accessori vedi da pag. 71. **Finiture: vedi sportello Modular 2T**

**MODULAR 2 ACC**

Complete through mounting double-sided mailbox, in electrogalvanized sheet steel and accessories panel designed for incorporating doorbells, video camera, intercom and residence number for models Biticino Sfera. Accessories, see from page 71.

Types of finish: see Modular 2T door

(confezione 6 pezzi)

**SPORTELLO SP2F per Modular 2T**

Sportello frontale per Modular 2T, completo di elemento mobile, in profilato d'alluminio:

- anodizzato argento
- anodizzato bronzo
- verniciato rosso RAL 3003 con elemento mobile ghisa
- verniciato verde RAL 6005 con elemento mobile ghisa
- verniciato bianco RAL 9016
- verniciato ghisa
- verniciato ghisa con elemento mobile in ottone
- con Kit Pubblicità

**Sportello Modular SP2R**

- Sportello Modular SP2R retro, per Modular 2T, finiture come per SP2F completa di serratura

È possibile avere la Modular 2T anche con il nuovo sportello della Serie Curve 2 (SP2F + SP2R vedi pag. 51).

**Tutta la Serie MODULAR viene fornita con corpo e sportelli smontati.**

(6-pieces package)

**DOOR SP2F for Modular 2T**

Aluminium profile front door for Modular 2T, complete with flap:

- anodized - silver
- anodized - bronze
- painted in RAL 3003 red, with cast-iron grey flap
- painted in RAL 6005 green, with cast-iron grey flap
- painted in RAL 9016 white
- painted in cast-iron grey
- painted in cast-iron grey with brass flap
- with publicity kit

**Modular SP2R Door**

- Rear door Modular SP2R for Modular 2T. Same finishes as SP2F, complete with lock

It's possible to supply Modular 2T with new Curve 2 door (SP2F + SP2R see page 51).

**MODULAR series mailboxes are supplied in loose form ready for assembly.**



**AM1**

Kit antivandalo con chiusura a tre punti per modello SP2R.

**AM1**

Anti-vandal kit with three-point lock for SP2R door.



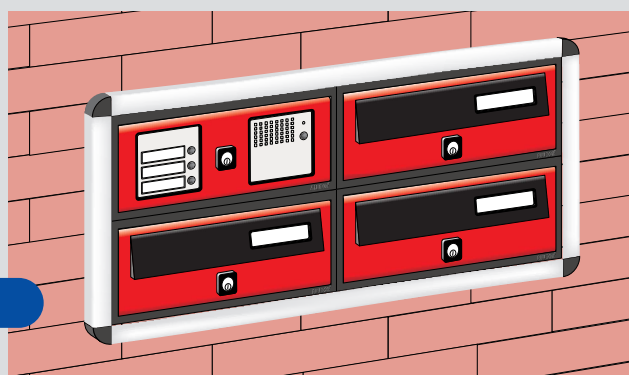
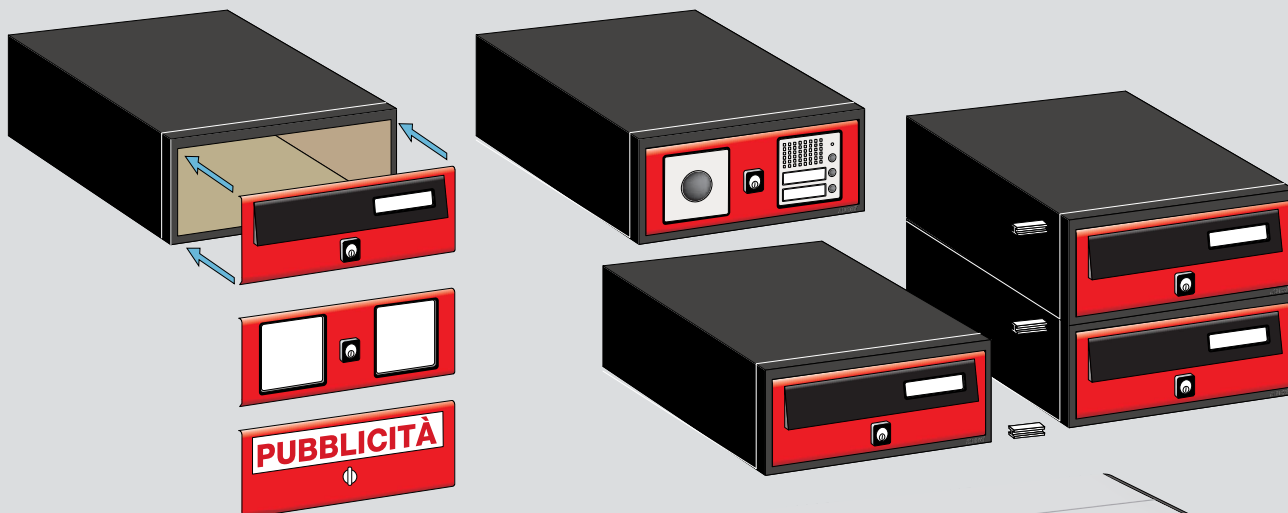

Composizione da incasso con cornice coprifuga  
Configuration for recessed mounting with external frame



Composizione con mantello per esterni  
Configuration with outer casing for outdoors

62

Composizione semincasso con mantello  
Configuration with outer casing for semi-recessed mounting

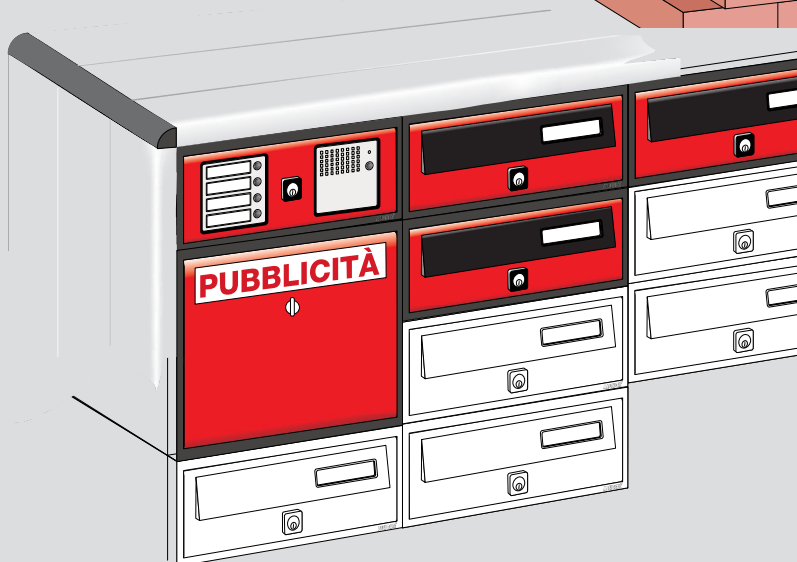
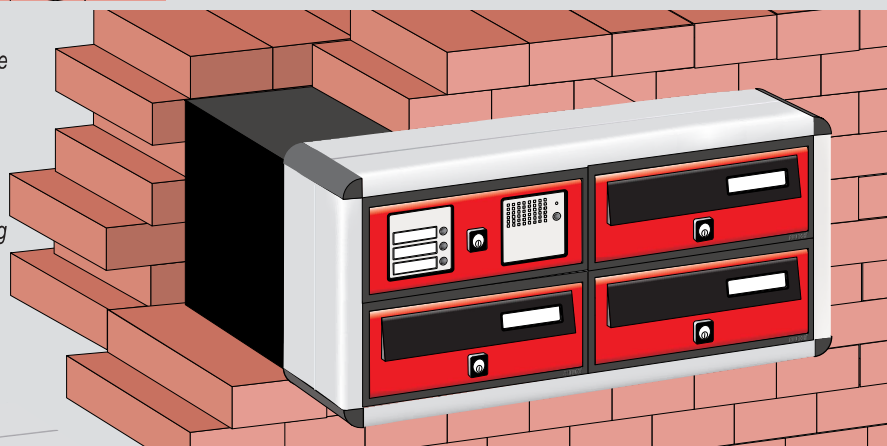

Composizione con mantello, sportello SP1 270 ACC predisposto per l'inserimento di campanelli, telecamera, citofono e numero civico per i modelli Bticino Sfera e corpo doppio pubblicità. Accessori vedi da pag. 71.

Example of configuration with outer casing, composed to SP1 270 ACC door suitable for door bells videocamera intercom, residence number for Bticino Sfera brand and double box for advertising. Accessories, see page 71.





Modular C270 CGH  
con cornice di plastica ghisa  
with cast-iron grey plastic frame



Modular C270 CAR  
con cornice di plastica argento -with silver plastic frame



Modular C270 CBI  
con cornice di plastica bianca -with white plastic frame

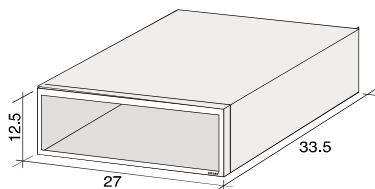

Modular C270

(confezione da 6 pezzi)

**CORPO MODULAR C270  
PRELIEVO FRONTALE**

**C270** • Corpo per cassetta componibile  
in alluminio

**C270F** • Corpo per cassetta componibile in  
lamiera elettrozincata

(6-pieces package)

**MODULAR C 270 BODY  
FRONT ACCESS**

**C270** • Body for modular mailbox - aluminium

**C270F** • Body for modular mailbox  
electroplated sheet steel

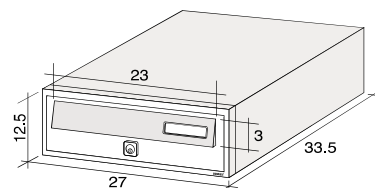

Modular 270 completa - Modular 270 complete box

**Modello con profondità maggiore e larghezza inferiore rispetto alla Modular 1 per consentire di utilizzare spazi ridotti.**

**Model with greater depth and narrower width than Modular 1 in order to use smaller areas.**



SP270/1AR



SP270/1BR



SP270/1RO / el. mob. ghisa



SP270/1VE / el. mob. ghisa



SP270/1BI



SP270/1GH



SP270/1OTT verniciato ghisa con elemento mobile in ottone.  
SP270/1OTT painted in cast-iron grey with polished brass flap



SP270/PUB  
con kit pubblicità (vedi pag. 34)  
with publicity kit (see page 34)



**SP1 270 ACC**

Sportello Serie MODULAR 270 in profilato d'alluminio predisposto per l'inserimento di campanelli, telecamera, citofono e numero civico per i modelli Bticino Sfera. Accessori vedi da pag. 71.

**Finiture: vedi sportello Modular SP1/270**

**SP1 270 ACC**

MODULAR 270 series panel in aluminium profile designed for incorporating doorbells, video camera, intercom and residence number for models Bticino Sfera. Accessories, see from page 71.

**Types of finish: see Modular SP1/270 door**

(confezione 6 pezzi)

**SPORTELLO Modular SP270/1**

Sportello per Modular 270/1 completo di elemento mobile, in profilato d'alluminio.

- anodizzato argento
- anodizzato bronzo
- verniciato rosso RAL 3003 con elemento mobile ghisa
- verniciato verde RAL 6005 con elemento mobile ghisa
- verniciato bianco RAL 9016
- verniciato ghisa
- verniciato ghisa con elemento mobile in ottone
- con Kit Pubblicità

**Tutta la Serie MODULAR viene fornita con corpo e sportelli smontati.**

(6-pieces package)

**Modular SP270/1 DOOR**

Aluminium profile door for Modular 270/1, complete with flap:

- anodized - silver
- anodized - bronze
- painted in RAL 3003 red, with cast-iron grey flap
- painted in RAL 6005 green, with cast-iron grey flap
- painted in RAL 9016 white
- painted in cast-iron grey
- painted in cast-iron grey with brass flap
- with publicity kit

**MODULAR series mailboxes**

are supplied in loose form ready for assembly.



(confezione da 1 pezzo)

**CORPO DOPPIO** con sportello pubblicità.

(1-piece package)

**DOUBLE HEIGHT BOX** with publicity door.

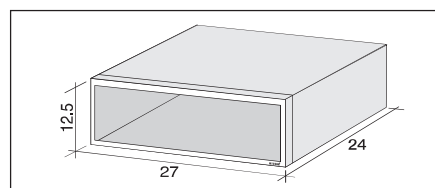

Modular 2401

**C2401** • Corpo per cassetta componibile in alluminio con profondità 24 cm.

**SOLO DA INCASSO CON CORNICE  
NON CONFORME ALLE NORMATIVE EN 13724**

**C2401** • Body for modular mailbox  
aluminium with 24 cms depth.

**ONLY FOR RECESS MOUNTING  
WITH EXTERNAL FRAME.**

**NOT IN ACCORDANCE WITH EUROPEAN  
STANDARD RULES EN 13724**

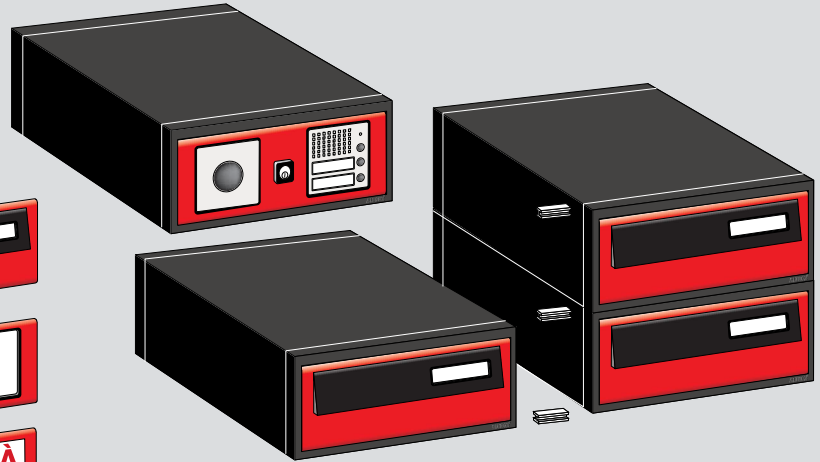
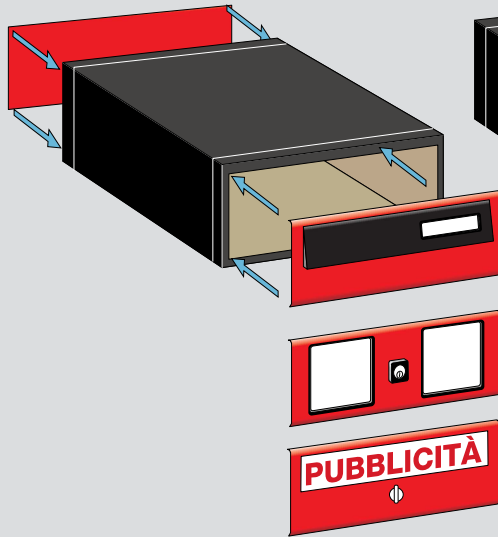

Composizione con mantello da recinzione  
Configuration with outer casing for fence mounting

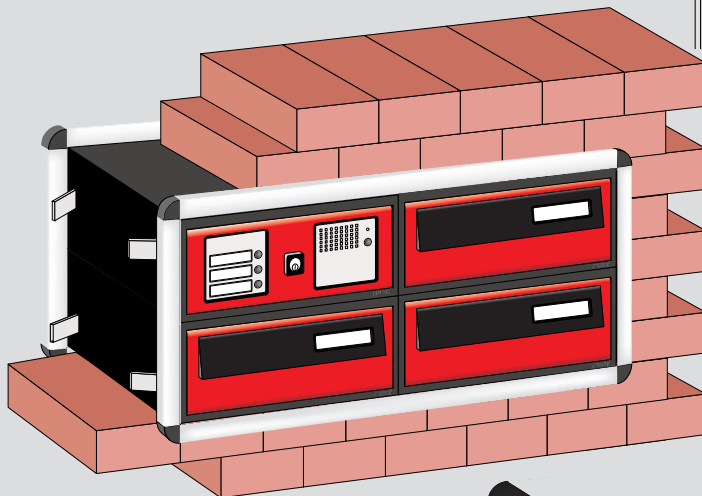
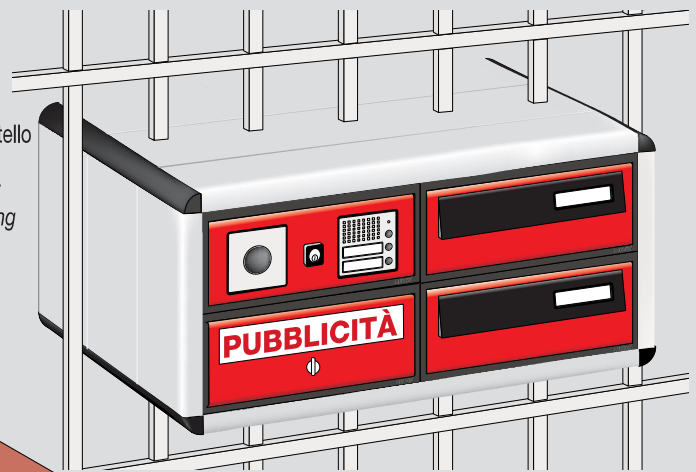

Composizione da incasso con doppia cornice  
Configuration for recessed mounting with double external frame

Composizione con mantello, sportello SP1 270 ACC predisposto per l'inserimento di campanelli, telecamera, citofono e numero civico per i modelli Bticino Sfera e corpo doppio pubblicità. Accessori vedi da pag. 71.

Example of configuration with outer casing, composed to SP1 270 ACC door suitable for door bells videocamera intercom, residence number for Bticino Sfera brand and double box for advertising. Accessories, see page 71.

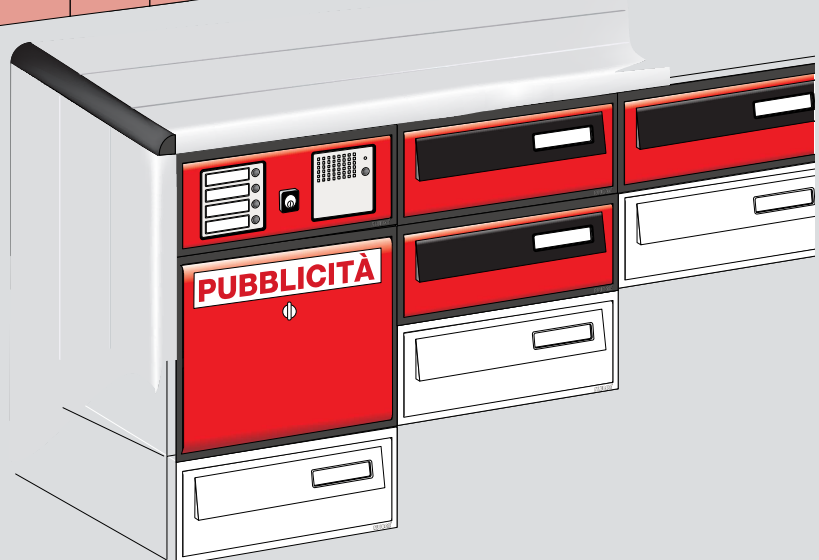



**SP270/2F**

Fronte - Front view

**SP270/2R**

Retro - Rear view



Modular C 270/2 CGH  
con cornice di plastica ghisa  
with cast-iron grey plastic frame



Modular C 270/2 CAR  
con cornice di plastica argento - with silver plastic frame



Modular C 270/2 CBI  
con cornice di plastica bianca - with white plastic frame

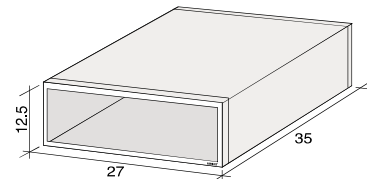

Modular C 270/2

(confezione da 6 pezzi)

**CORPO MODULAR C270/2  
PRELIEVO POSTERIORE**

- C270/2** • Corpo per cassetta componibile bifrontale in **alluminio**
- C270/2F** • Corpo per cassetta componibile bifrontale in **lamiera elettrozincata**

(6-pieces package)

**MODULAR C270/2 BODY  
REAR ACCESS**

- C270/2** • Body for double-sided modular mailbox - **aluminium**
- C270/2F** • Body for double-sided modular mailbox **electrogalvanized sheet steel**

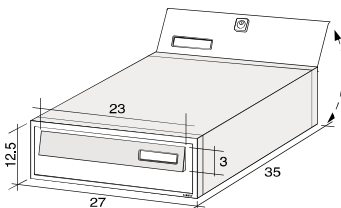

Modular 270/2 completa - Modular 270/2 complete box

**Modello con profondità maggiore e larghezza inferiore rispetto alla Modular 2 per consentire di utilizzare spazi ridotti.**

**Model with greater depth and narrower width than Modular 2 in order to use smaller areas.**



SP270/2FAR



SP270/2FBR



SP270/2FRO / el. mob. ghisa

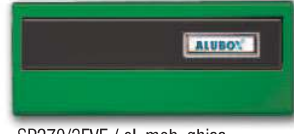

SP270/2FVE / el. mob. ghisa



SP270/2FBI

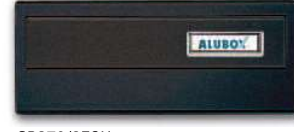

SP270/2FGH



SP270/2FOTT verniciato ghisa con elemento mobile in ottone.  
SP270/2FOTT painted in cast-iron grey with polished brass flap



SP270/PUB  
con kit pubblicità (vedi pag. 34)  
with publicity kit (see page 34)



**SP1 270 ACC**

Sportello Serie MODULAR 270 in profilato d'alluminio predisposto per l'inserimento di campanelli, telecamera, citofono e numero civico per i modelli Bticino Sfera. Accessori vedi da pag. 71.

**Finiture: vedi sportello Modular SP1/270**

**SP1 270 ACC**

MODULAR 270 series panel in aluminium profile designed for incorporating doorbells, video camera, intercom and residence number for models Bticino Sfera. Accessories, see from page 71.

**Types of finish: see Modular SP1/270 door**

(confezione 6 pezzi)

**SPORTELLO Modular SP270/2F**

Sportello frontale per Modular 270/2 completo di elemento mobile, in profilato d'alluminio:

- anodizzato argento
- anodizzato bronzo
- verniciato rosso RAL 3003 con elemento mobile ghisa
- verniciato verde RAL 6005 con elemento mobile ghisa
- verniciato bianco RAL 9016
- verniciato ghisa
- verniciato ghisa con elemento mobile in ottone
- con Kit Pubblicità

**SPORTELLO Modular SP270/2R**

• Sportello Modular SP270/2R retro, per Modular 270/2 finiture come per SP270/2F completa di serratura.

**Tutta la Serie MODULAR viene fornita con corpo e sportelli smontati.**

(6-pieces package)

**Modular SP270/2F DOOR**

Aluminium profile front door for Modular 270/2, complete with flap:

- anodized - silver
- anodized - bronze
- painted in RAL 3003 red, with cast-iron grey flap
- painted in RAL 6005 green, with cast-iron grey flap
- painted in RAL 9016 white
- painted in cast-iron grey
- painted in cast-iron grey with brass flap
- with publicity kit

**Modular SP270/2R Door**

- Rear door Modular SP270/2R for Modular 270/2
- Same finishes as SP270/2F, complete with lock.

**MODULAR series mailboxes are supplied in loose form ready for assembly.**



(confezione da 1 pezzo)

**CORPO DOPPIO con sportello pubblicità.**

(1-piece package)

**DOUBLE HEIGHT BOX with publicity door.**

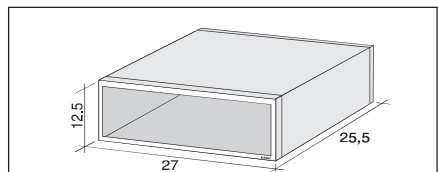

Modular 2402

- C2402** • Corpo per cassetta componibile in alluminio con profondità 25,5 cm.

**SOLO DA INCASSO CON CORNICE  
NON CONFORME ALLE NORMATIVE EN 13724**

- C2402** • Body for modular mailbox aluminium with 25.5 cms depth.

**ONLY FOR RECESS MOUNTING  
WITH EXTERNAL FRAME.**

**NOT IN ACCORDANCE WITH EUROPEAN  
STANDARD RULES EN 13724**



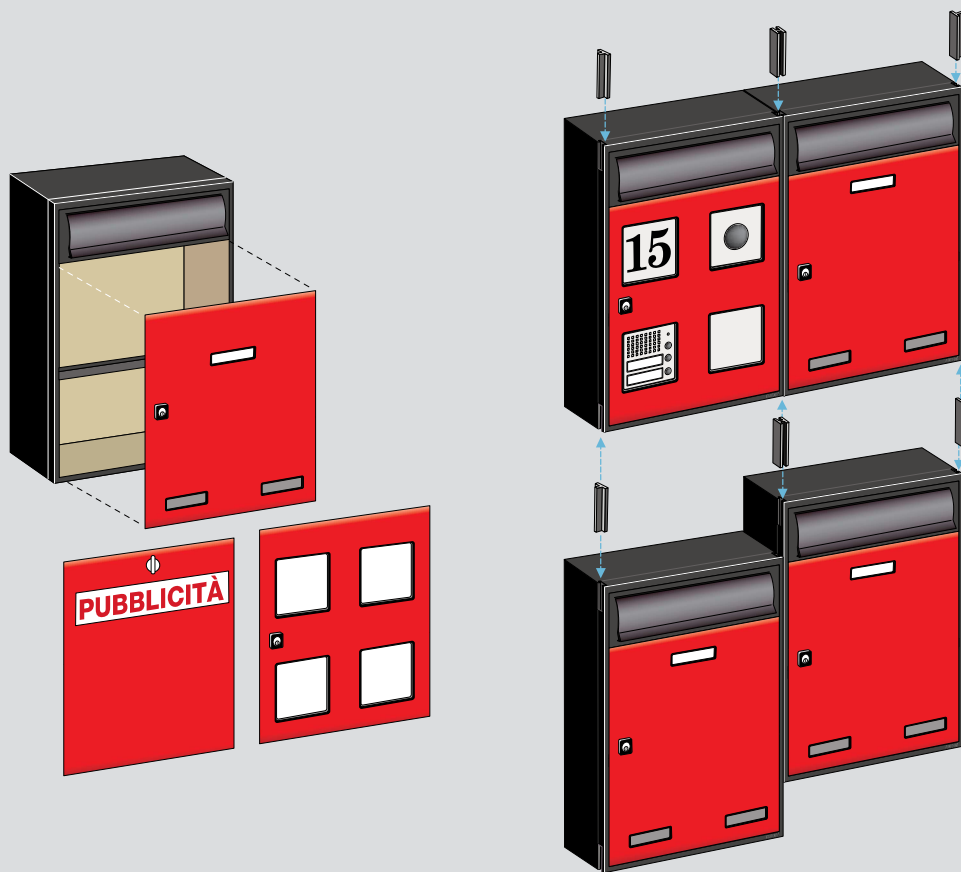

66



Composizione con mantello  
Configuration with outer casing

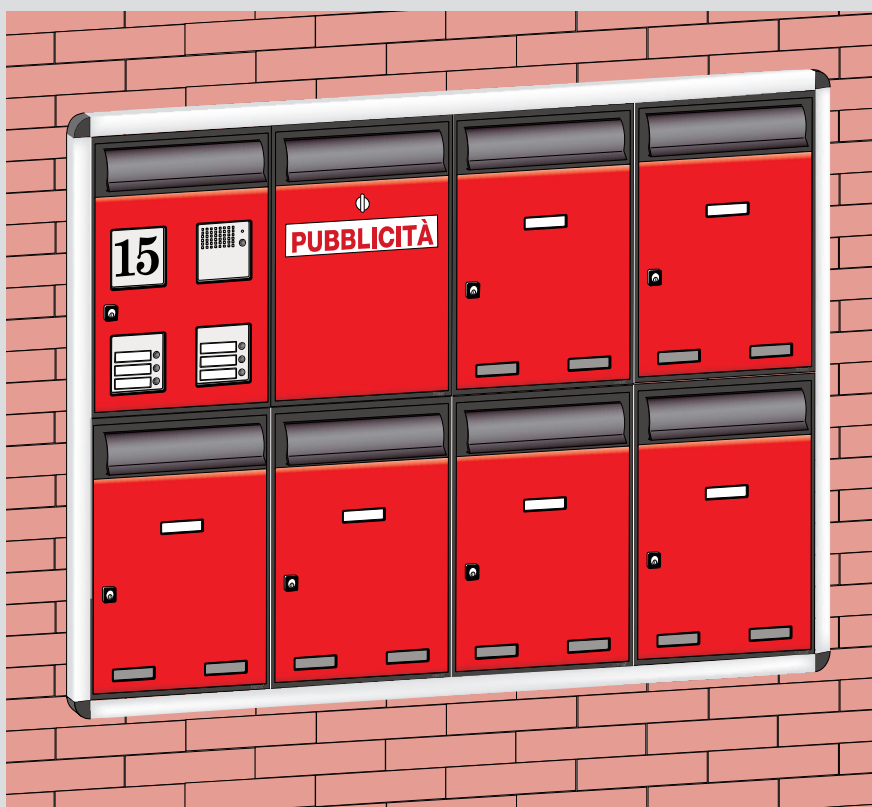

Composizione da incasso con cornice coprifuga  
Configuration for recess mounting with cover frame



Modular 3 completa  
Modular 3 complete box



Modular C3 CGH  
con cornice di plastica ghisa  
ed el. mob. color ghisa  
with cast-iron grey plastic  
frame and cast-iron grey flap



Modular C3 CAR  
con cornice di plastica argento  
ed el. mob. color argento  
with silver plastic frame and  
silver flap



Modular C3 CBI  
con cornice di plastica bianca  
ed el. mob. color bianco  
with white plastic frame and  
white flap

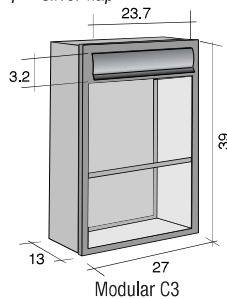

(confezione 6 pezzi)

### MODULAR C3 FRONTALE

Corpo per cassetta componibile passante in alluminio completo di elemento mobile in profilato d'alluminio.

(6-pieces package)

### MODULAR C3 FRONT ACCESS

Aluminium body for through mounting modular mailbox complete with aluminium profile flap.



SP3AR



SP3BR



SP3VE



SP3RO



SP3BI



SP3GH



SP3PUB  
con kit pubblicità  
(vedi pag. 34)  
with publicity kit  
(see page 34)



SP3 ACC  
Sportello in alluminio porta accessori Bticino Sfera (vedi pag. 71).  
Finiture: vedi Modular SP3

SP3 ACC  
Aluminium accessories panel for Bticino Sfera brand. (see page 71).  
Types of finish: see Modular SP3

(confezione 6 pezzi)

### SPORTELLO Modular SP3

Sportello per Modular 3 in alluminio:

- Anodizzato argento
- Anodizzato bronzo
- Verniciato bianco Ral 9016
- Verniciato verde Ral 6005
- Verniciato rosso Ral 3003
- Verniciato ghisa
- con Kit Pubblicità

Tutta la Serie MODULAR viene fornita con corpo e sportelli smontati.

(6-pieces package)

### Modular SP3 DOOR

Aluminium Modular 3 door:

- anodized - silver
- anodized - bronze
- painted in RAL 9016 white
- painted in RAL 6005 green
- painted in RAL 3003 red
- painted - cast-iron grey
- with publicity kit

MODULAR series mailboxes are supplied in loose form ready for assembly.



AM3  
Kit antivandalo con chiusura in tre punti per modello SP3.

AM3  
Anti-vandal kit with three-point lock for SP3 door.



Modular C3/2 CGH  
con cornice di plastica ghisa  
ed el. mob. color ghisa  
with cast-iron grey plastic  
frame and cast-iron grey flap



Modular C3/2 CAR  
con cornice di plastica argento  
ed el. mob. color argento  
with silver plastic frame and  
silver flap



Modular C3/2 CBI  
con cornice di plastica bianca  
ed el. mob. color bianco  
with white plastic frame and  
white flap

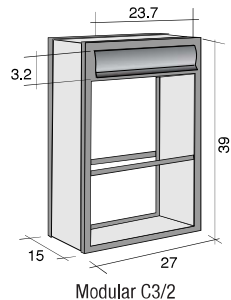

(confezione 6 pezzi)

### MODULAR C3/2 PASSANTE

Corpo per cassetta componibile passante in alluminio completo di elemento mobile in profilato d'alluminio.

(6-pieces package)

### MODULAR C3/2 THROUGH MOUNTING

Aluminium body for through mounting modular mailbox complete with aluminium profile flap.



Retro Modular C3/2  
con elemento mobile bloccato  
Modular C3/2 rear view with fastened flap