

Classic Series

Version 5.0



Assembly & Maintenance Manual

JumpFlex™

play for life

Jumpflex Trampoline Assembly & Maintenance Manual

- 8ft Flex80 | Studio
- 10ft Flex100 | City
- 12ft Flex120 | Urban
- 14ft Flex140 | Lifestyle
- 15ft Flex150 | Estate



Australia

☎ 1800 586 735

jumpflex.com.au



New Zealand

☎ 0800 586 735

jumpflex.co.nz



USA

☎ 1866 305 7238

jumpflex.com



Canada

☎ 1866 305 7238

jumpflex.ca



UK

☎ 808 196 1138

jumpflex.co.uk



Warning: Read all assembly, installation, care, maintenance and use instructions in the manual prior to assembling and using this Jumpflex product.

These products are for personal use only by 1 person aged 6 years and older, for outdoor use.

Warning: For domestic use only. Adult assembly required.

Risk Warning: The use of this product involves a significant risk of participants suffering personal injury including the possibility of serious injuries, permanent disability or death. All participants who engage in activities with the product do so at their own risk.

Contents

1	Notice to User
2	Safety Information
3	Maintenance and Care Instructions
4	Warranty information
5	Trampoline Location
6	Trampoline Parts List
7	Trampoline Assembly Instructions
21	Trampoline Ladder Assembly instructions



Notice | Instructions

Notice to User

Please read this agreement carefully before purchase or assembly. By opening this package, you acknowledge that you have read this agreement, understand it and agree to be bound by its terms. If you are making a purchase on behalf of another person, you agree that you are making the purchase as their agent.

Please Read

Jumpflex as a supplier of trampolines and Accessories, (“Equipment”), sells all Equipment subject to the following conditions:

1. To the maximum extent permitted by law, Jumpflex, its employees, directors and agents will not be liable to the customer, their dependents or legal representatives for damage to property, personal injury or death suffered by the customer because the Equipment was not manufactured or supplied with due care and skill, the Equipment is not reasonably fit for its purpose or because of negligence, breach of contract, breach of statute or breach of statutory duty by Jumpflex.
2. Jumpflex, its employees, directors and agents are not liable to the customer, their dependents or legal representatives for personal injury or death suffered by the customer because the Equipment was not:
 - a. Installed in accordance with the Jumpflex Assembly Manual. It is the customer’s responsibility to check all boxes to confirm that all components are included and in the correct condition before assembly.
 - b. Installed with due care and skill, by the customer or a third party assembly service, and in the same condition as when the Equipment was supplied, due to wear and tear including, but not limited to, weather damage, deterioration of the net, spring stretch, UV deterioration or rust.

The customer acknowledges that using this Equipment can be dangerous, with inherent risks and hazards. As a consequence, personal injury or death may occur. The customer assumes and accepts all such risks to the full extent permitted by law and waives any right of action against, and fully releases Jumpflex for all loss, damages, personal injury or death in any way caused by, or relating to, the customer’s use of the Equipment. This includes, without limitation, liability for any negligent or tortuous acts or omissions, breach of duty, breach of contract or breach of statutory duty on the part of Jumpflex, its officers, directors, employees or agents.

Risk Warning

The use of this Equipment involves a significant risk of participants suffering personal injury including the possibility of serious injury, permanent disability or death. All participants who use the Equipment do so at their own risk.

Safety | Instructions

Specific Use Limitations

1. Do not use trampoline without mature and knowledgeable supervision.
2. Do not attempt or allow somersaults.
3. Do not allow more than one person on the trampoline at any time.
4. Do not use the trampoline if it's raining or wet.
5. Do not jump onto or off of the trampoline.
6. Do not use a trampoline while under the influence of drugs or alcohol.
7. Do not allow any activity underneath the trampoline.
8. Learn fundamental bounces and body positions thoroughly before attempting more advanced skills.
9. Properly secure the trampoline when not in use to protect against unauthorised use. If a trampoline ladder is used, the supervisor should remove it from the trampoline when leaving the area.
10. The trampoline must not be used in gusty or severe winds and only when wind or air movement is calm and gentle.

Safety Instructions

1. Read all instructions before using the trampoline.
2. Allow only one person on the trampoline at any time. Use by more than one person at the same time can result in serious injury.
3. Use the trampoline only with mature adult supervision at all times.
4. Inspect the trampoline before each use. Make sure the frame padding is correctly and securely positioned. Replace any worn, defective, or missing parts.
5. Keep objects away that could interfere with the user. Maintain a clear area around, above, and under the trampoline.
6. Misuse and abuse of the trampoline is dangerous and can cause serious injuries.
7. Focus your eyes on the edge of the trampoline. This will help control your bounce.
8. Avoid bouncing for too long. Do not bounce when tired.
9. Stop your bounce by flexing your knees as your feet come in contact with the trampoline bed. Learn this skill before you attempt any others.
10. Climb on and off the trampoline - do not jump. Jumping from the trampoline to the ground is dangerous. Similarly, do not run and leap onto the trampoline.
11. Never use springs or extension elements as 'hand grips'.
12. Avoid bouncing too high. Stay low until you can control your bounce and repeatedly land in the centre of the trampoline.
13. Do not use the trampoline as a springboard to other objects. Use the trampoline only for trampoline style bouncing.
14. It is advisable not to bounce immediately after a meal.
15. Do not attempt knee drops. This can cause injury if you attempt this skill without some experience or personal instruction.
16. Your clothing should allow plenty of freedom of movement, but loose clothing is discouraged.
17. No buckles or jewellery should be worn, as these could damage the trampoline mat and cause injury to the jumpers.
18. Do not wear shoes while bouncing on the trampoline unless they are designed specifically for use on a trampoline.
19. Remove ladder when it is not in use to prevent young children falling and injuring themselves.
20. Avoid bringing any miscellaneous items onto the trampoline.
21. Trampoline safety net must always be fitted to trampoline to promote safer use of the trampoline.
22. Refrain from eating or drinking on the trampoline to avoid spillages and potential injury as a result.
23. Remember to wear suitably sun-protective clothing, sunscreen and a hat (soft, not hard) to avoid becoming sunburned.
24. For further information or additional instructional materials, contact Jumpflex or your nearest trampoline club.
25. Jumpflex does not condone pets to be on the trampoline at any time, as sharp claws may also cause damage to the safety netting, jumping mat, or safety padding of the trampoline.

Maintenance | Instructions

Your trampoline is a substantial investment for the enjoyment of your family, and it must be noted that improper use or lack of care can lead to early deterioration. Please follow all of the points below to ensure your product lasts as long as possible.

General Care

1. We strongly recommend cleaning your Jumpflex Trampoline and accessories every month with warm soapy water. When dirt and other particles are left to build up on the trampoline, this can cause wear and tear to accelerate.
2. When your trampoline is not going to be used for a long period of time, it is best to store it out of the weather.
3. Protect and secure your trampolines in extreme weather such as strong winds, hail and lightning. An effective way to prevent damage under these extreme circumstances is to cover the trampoline with an appropriate protective cover and to secure the trampoline to the ground to avoid it being moved by strong winds.
4. Inspect the trampoline before each use and replace any worn, defective, or missing parts.

Safety Padding

5. Dirt and dust build up on the Safety Pad if left with accelerate the deterioration of the Padding. Your Safety Padding should be cleaned once a month with warm soapy water.
6. Trampoline safety padding is made from highly water resistant and UV-resistant material to withstand sun exposure. The safety padding is designed to be able to be drained in the event water becomes trapped inside, as this can accelerate the deterioration of the padding. If water becomes trapped, lift the pads from the inside edge to drain the water out.
7. Safety padding must be kept loose above the springs. Under no circumstances should the safety padding be leaned on, sat on, or stood on. This weight applies direct contact to the springs and can cause ripping in the safety pads and/or injury.
8. In areas that experience extreme cold, remove and store the safety pads indoor in winter. This will prevent any possible cracking due to sub-zero temperatures.
9. Under no circumstances should any object hotter than 120 degrees Fahrenheit or 48 degrees Celsius come into contact with any part of the safety padding. High temperatures may result in melting or burning of the padding material and extreme temperatures may cause the padding to catch fire.
10. Rainwater, if not wiped off, may result in spots forming from residue left from the water as it dries. Any water applied to clean the surface must be wiped dry with a clean cloth or chamois and not left to dry in the sun.

Safety net

1. Inspect the trampoline enclosure before each use.
2. Prolonged exposure of the safety net of UV rays from the sun can lead to a shortened lifespan of the material. During the winter months or when the trampoline will not be in use for a long time, e.g. winter or storm seasons, remove the safety net and store indoors in a cool dry place out of sunlight.
3. The user of the trampoline must not have any solid or sharp objects present on their person while using the trampoline. These foreign objects may cause damage to the safety netting, jumping mat or safety padding.
4. Always check for any defects in the safety netting poles before using your trampoline.
5. Regularly check that the safety netting pole bolt assembly remain in a working state, are completely fastened and are tight.
6. The safety net must be in use at all times.

Warranty | Information

Jumpflex Ltd, Jumpflex Pty Ltd Limited Trampoline Warranty

Warranty Coverage

Jumpflex Ltd and it's authorised service partners warrant it's products to be free of defects in material and workmanship under normal domestic recreational use and service conditions. The various component parts of the trampoline are warranted against failure and defects in the workmanship as follows:

FRAME:	10 YEARS
JUMP MAT & SPRINGS:	5 YEARS
SAFETY PAD & SAFETY NET:	3 YEARS
JUMPFLEX ACCESSORY RANGE:	1 YEAR

The warranty in respect of the mat and the enclosure net does not cover normal wear and tear (e.g. stitching wear due to use), burns, cuts or snags. The warranty on the frame does not cover surface rust. Warranty claims resulting from manufacturing QC defects e.g. cuts in mats, broken D-rings, tears in net, missing components etc must be reported within 45 days of the product being purchased. Warranty claims reported outside the initial 45 days purchase period may be rejected by Jumpflex Ltd. Shipping costs associated with approved warranty claims during this 45 day period will be borne by Jumpflex Ltd. Beyond this 45 day period, all shipping costs must be borne by the purchaser.

JUMPFLEX LTD, JUMPFLEX PTY LTD IS NOT RESPONSIBLE OR LIABLE FOR INDIRECT, SPECIAL OR CONSEQUENTIAL DAMAGES ARISING OUT OF OR IN CONNECTION WITH THE USE OR THE PERFORMANCE OF THE PRODUCT OR ANY OTHER DAMAGES WITH RESPECT TO ANY ECONOMIC LOSS, LOSS OF PROPERTY, LOSS OF REVENUE OR PROFITS, LOSS OF ENJOYMENT OR USE, COST OF REMOVAL, INSTALLATION/DISASSEMBLY OR OTHER CONSEQUENTIAL DAMAGES. SOME STATES/TERRITORIES DO NOT ALLOW THE EXCLUSION OR LIMITATION OF INCIDENTAL OR CONSEQUENTIAL DAMAGES. ACCORDINGLY THE ABOVE LIMITATIONS MAY NOT APPLY TO YOU.

THE WARRANTY EXTENDED HEREUNDER IS IN LIEU OF ALL OTHER WARRANTIES AND ANY IMPLIED WARRANTY OF MERCHANTABILITY, OR FITNESS FOR A PARTICULAR PURPOSE IS LIMITED IN ITS SCOPE AND DURATION TO THE TERMS SET FORTH HEREIN. SOME STATES/TERRITORIES DO NOT ALLOW LIMITATIONS ON HOW LONG AN IMPLIED WARRANTY LASTS. ACCORDINGLY THE ABOVE LIMITATIONS MAY NOT APPLY TO YOU. THIS WARRANTY IS NOT TRANSFERABLE.

Trampoline | Location

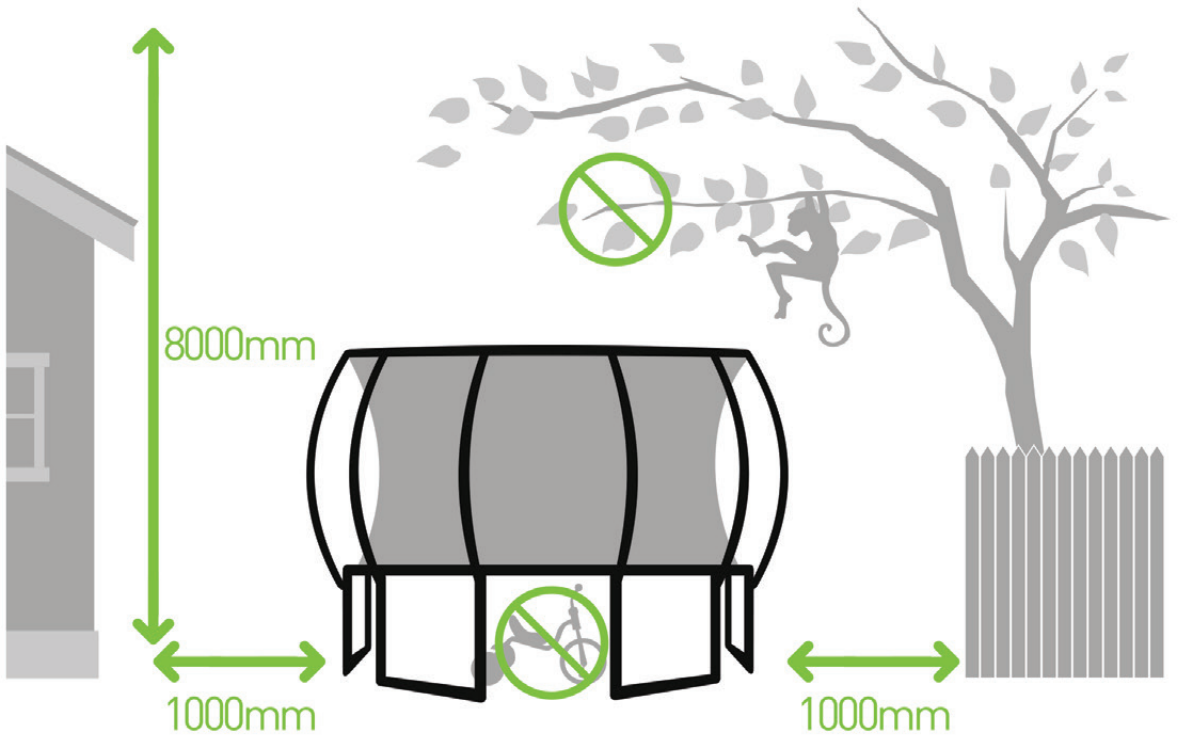

- Minimum overhead clearance of 8m / 26 ft from ground level. Possible hazards may include wires and tree limbs.
- Recommended clearance of 1000mm from obstacles such as walls, structures, fences and other play areas.
- Keep the trampoline on a level surface
- The trampoline must not be used in gusty or severe winds.



Trampoline | Assembly Instructions

Trampoline | Parts List

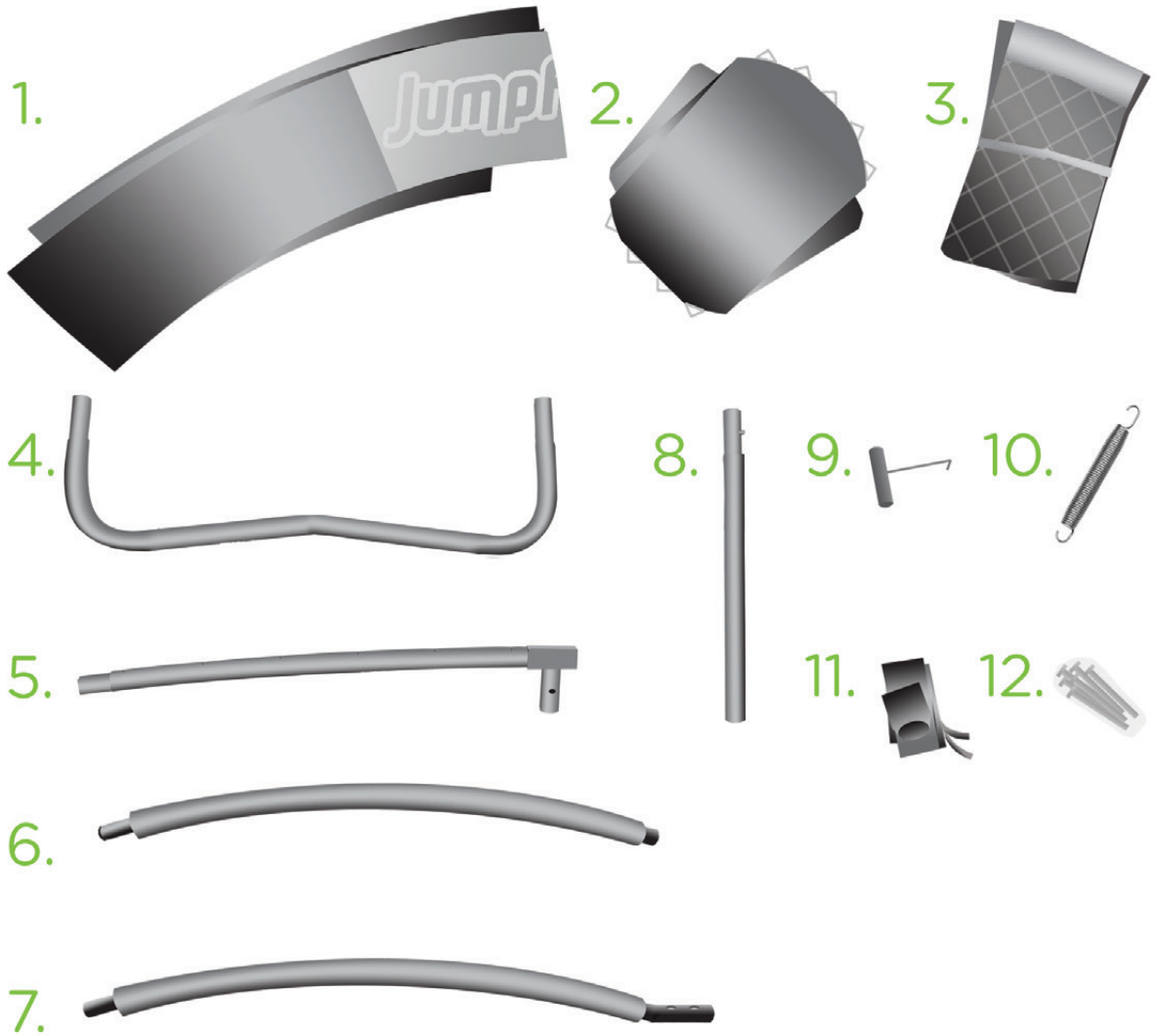

	Part Type	8 FT	10 FT	12 FT	14FT	15FT
1	Spring Pad	1	1	1	1	1
2	Jump Mat	1	1	1	1	1
3	Safety Net	1	1	1	1	1
4	Foot	3	4	4	5	5
5	Top Rail	6	8	8	10	10
6	Upper Safety Net pole	6	8	8	10	10
7	Lower Safety Net pole	6	8	8	10	10
8	Leg	6	8	8	10	10
9	Spring Tool	1	1	1	1	1
10	Springs	48	64	72	90	100
11	PVC Sleeves	6	8	8	10	10
12	Nuts & Bolts	12	16	16	20	20

Trampoline | Assembly Instructions

01

Take out all of the curved top rail poles and join them together in lots of 2, like shown.

Note: 8 ft size = 3 pairs (6 top rails)
10ft size = 4 pairs (8 top rails)
12ft size = 4 pairs (8 top rails)
14ft size = 5 pairs (10 top rails)
15ft size = 5 pairs (10 top rails)

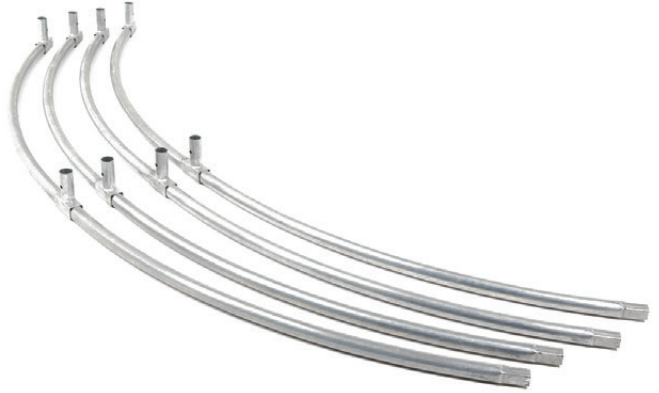

02

Take out all of the black w-shaped Feet and connect on each end the short straight black Leg poles. Make sure the silver spring button clip is aligned and clicks into place, securing the poles together.

Assemble all of the w-shaped Feet and Legs like shown, these will be the legs and feet of the trampoline.

Note: 8ft size = 3 feet rails
10ft size = 4 feet rails
12ft size = 4 feet rails
14ft size = 5 feet rails
15ft size = 5 feet rails



03

Take the assembled w-shaped component (trampoline legs and feet) and connect each end into the paired top rails. Repeat this for all components.

Tip: Insert the two legs evenly and at the same time, otherwise this step might be difficult.



Trampoline | Assembly Instructions

04

Safety net pole assembly

Take out the curved poles with the black foam surround.

Connect them together in pairs, with one black pole and one silver pole making a pair.

- Note:
- 8ft size = 6 assembled poles
 - 10ft size = 8 assembled poles
 - 12ft size = 8 assembled poles
 - 14ft size = 10 assembled poles
 - 15ft size = 10 assembled poles



05

Once you have assembled all the safety net poles, take out the black PVC sleeves and slide the open end over the top of the curved safety net pole and slide this down over the pole (top = plastic cap).



- Tip: Make sure the foam does not slide down the pole by squeezing the foam against the pole with one hand, while pulling down the black sleeve with the other. Once the sleeve is on make sure the foams are flush with the top of the pole, and are touching in the centre.

06

Attaching the Safety Net poles to the top rail and feet component

Using the provided bolts, attach the safety net poles to the straight leg poles.

- Note: Make sure to attach the bolts in this order;

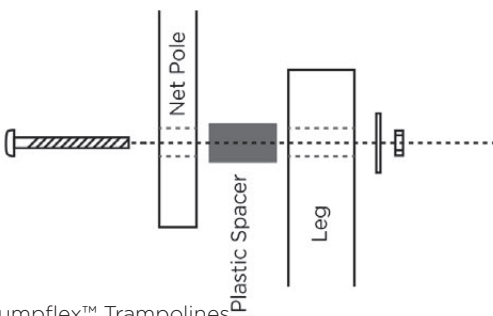

Trampoline | Assembly Instructions

07

 Important Note

When attaching the Safety Net pole to the top rail and feet component, make sure the small webbing strip is facing away from the curve as shown (facing towards the outside of the trampoline).



08

Attach all the safety net poles to the top rail and feet components as shown.



09

 Important Note

Secure the bottom of the black sleeve by feeding the webbing length under and around the bottom of the safety net pole. Lock the webbing in place by securing the plastic buckle.



Trampoline | Assembly Instructions

10

Connect the top rail and leg components together to create the complete frame of your trampoline.

Tip: Asking the help of an assistant with this step will make it a lot easier. Have your assistant stabilise each section while you carefully slot the components together.

Please take caution to make sure the components don't tip or fall over.



11

You should now have the complete trampoline frame connected as shown below.



Trampoline | Assembly Instructions

12

Now pre-hang all of the springs to the top rail frame, so they are ready to be attached to the Jump Mat.

Note: Hook the end of the spring that has the larger open hook to the frame. Make sure the springs are on the inside of the trampoline ring.



Trampoline | Assembly Instructions

13

Attaching the Jump Mat

Locate a Spring to the right of a Safety Net pole and attach this Spring to the Jump Mat D-Ring (attach the small hook end of the Spring to the Jump Mat).

Move to the next Safety Net pole and attached the Spring to the right of the pole to the Jump Mat D-Ring. You will need to count the number of D-Rings on the Jump Mat to make sure the number is equal to the number of Frame attachment points

Continue until you have attached a Spring at to the Jump Mat to the right of each Safety Net pole, as shown.

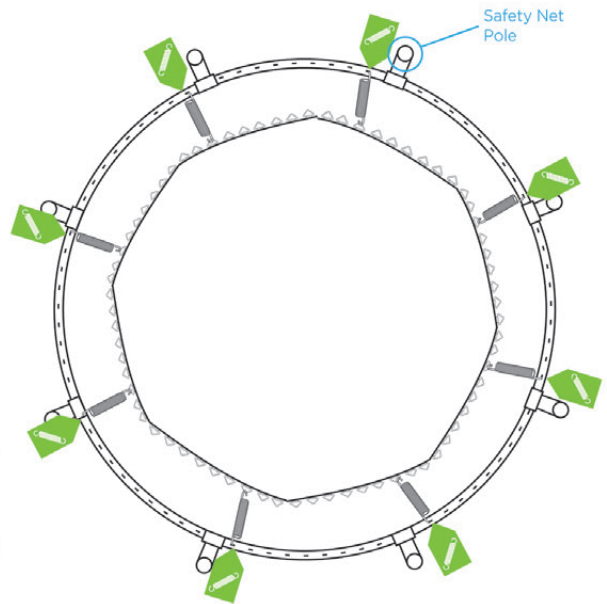

Note: Make sure to count out an equal number of Jump Mat D-Rings and Frame attachment points before attaching the next spring.

Tip: The easiest method of attaching a spring is to have the spring first hooked to the mat, and then use the spring tool to pull the spring out from the mat by using your entire body weight.

Then hook the end you pull into the frame. Place your other hand on the frame for support.



Trampoline | Assembly Instructions

14

Attaching the rest of the Springs to the Jump Mat

Working around the Trampoline, attach a second Spring to the Jump Mat to the right of each first Spring.

Remember to firstly attach the Spring to the Jump Mat then use the Spring tool to pull it towards you and hook it back onto the frame.

Continue to work around the Trampoline to attach a third Spring beside the previous Spring.

Follow the sequence as illustrated below to continue until all Springs have been attached.

Tip: It is important to attach the springs equally around the entire frame to ensure even distribution of Spring tension when attaching the Jump Mat.

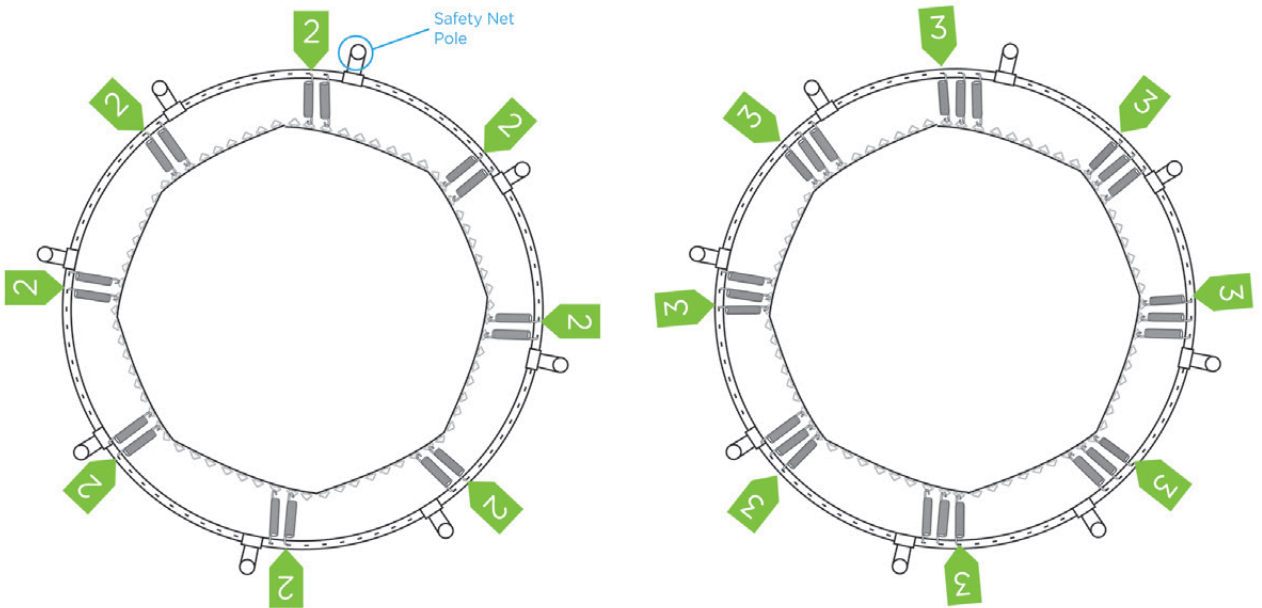

Trampoline | Assembly Instructions

15

Take out the Spring Padding and lay it around the Trampoline so that it sits on top of the Springs.

Align the green panel between the Safety Net poles as shown. This will be where you position the zip and ladder entrance.



16

On the underside of the Spring Pad there are stitched loops.

Find the Springs that are beneath these loops, remove them and push the Spring through. Reattach the Spring to the Mat then to the Frame using the Spring tool. Do this for each loop.



17

There are webbing straps located on the underside of the Spring Pad, tie these to the Trampoline frame. Continue until each one is tied and the Pad is secured to the Frame.



Trampoline | Assembly Instructions

18

Attaching the top of the Safety Net to the Poles

Locate the Zip entrance on the Safety Net. The Zip entrance needs to be positioned in the middle of the green panel on the Spring Pad. Find the Net pockets to either side of the Zip, using a step ladder attach these pockets to the Poles that are to the left and right of the green panel.

Slide the pocket over the top of the Safety Net pole while pushing the pole up into the pocket, ensure the foam remains flush with the top of the Safety Net pole.

Position the Zip in the middle of the Green panel



19

Secure the Net to the Pole by feeding the Velcro tag down through the webbing loop on the Safety Net pole as illustrated.

Note: If you push your finger through the webbing loop to open it up, this makes it easier to feed the Velcro through.



20

Fold the Velcro back up and onto itself to secure it. Do this on every pole to finish attaching the Net to the top of the Safety Net poles.



Trampoline | Assembly Instructions

21

Once you have hung the net from the Top of the Safety Net poles, as shown. It is now time to connect the bottom of the net to the Springs and Jump Mat.

Note: The Zip on the Net should be hanging in the middle of the Green Jumpflex Panel of the Spring Pad, as shown.



22

Starting at the Zip, centre the zip so it is hanging vertically, straight up and down, locate the metal ring below the zip and align this ring with the D-Ring on the Jump Mat. Counting the Springs between the Safety Net poles to the left and right can help locate the centre point.

23

Feed the Net ring **through** the Jump Mat D-Ring then hook the Net ring onto the Spring.

Continue around the bottom of the net attaching each Net ring through the Jump Mat D-Ring and onto the Spring until all Net rings are attached,

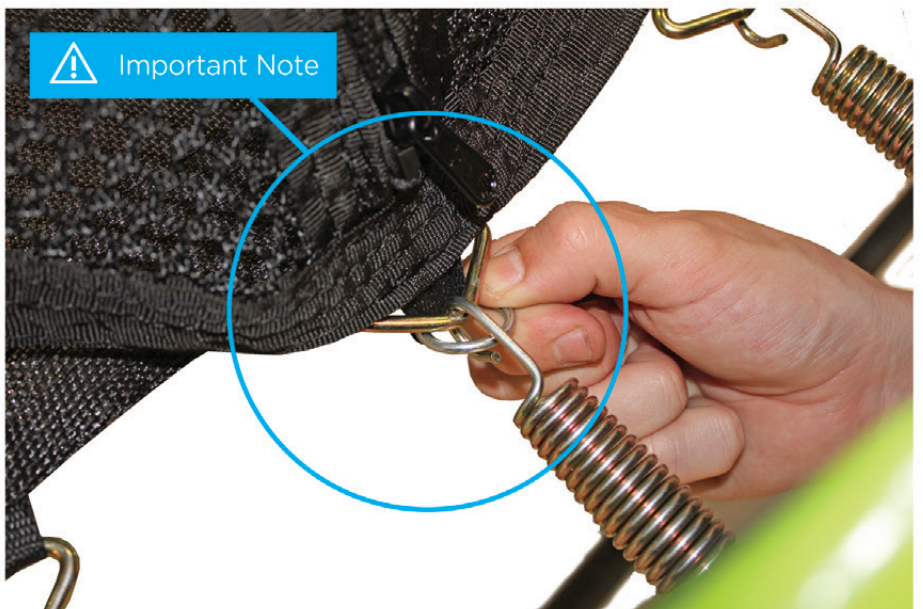

Trampoline | Assembly Instructions

24

Congratulations!

You have finished the assembly of your Jumpflex Trampoline.



Play for Life

“Stay active and have fun at the same time thanks to Jumpflex”

Playing on your new Jumpflex Trampoline has so many great health benefits. It's great for your heart, it's an efficient and easy way of exercising, it's easy on your joints, it helps you build strong bones, tones and strengthens muscles, it improves energy levels.... the list goes on!

Ladder | Assembly Instructions

Step | 1



Slide the black plastic step onto the ladder poles in the direction shown

Step | 2

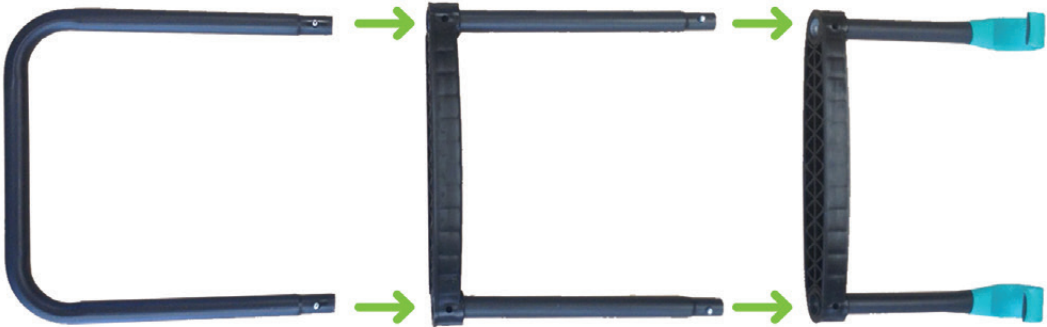

Note: The lower piece of the ladder will need to be splayed open slightly.

Step | 3

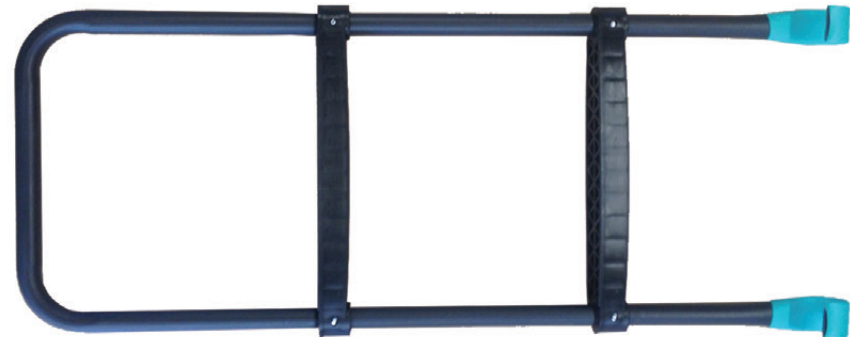

JumpFlex

play for life

 facebook.com/jumpflex

 Share your fun on instagram #Jumpflex



FIND JUMPFLEX

WORLDWIDE



Australia

 1800 586 735

jumpflex.com.au



New Zealand

 0800 586 735

jumpflex.co.nz



USA

 1866 305 7238

jumpflex.com



Canada

 1866 305 7238

jumpflex.ca



UK

 808 196 1138

jumpflex.co.uk



Warning: Read all assembly, installation, care, maintenance and use instructions in the manual prior to assembling and using this Jumpflex product.

These products are for personal use only by 1 person aged 6 years and older, for outdoor use.

Warning: For domestic use only. Adult assembly required.

Risk Warning: The use of this product involves a significant risk of participants suffering personal injury including the possibility of serious injuries, permanent disability or death. All participants who engage in activities with the product do so at their own risk.

