

Item type

Chandelier

Item name

Jet Set

Item number(s)

115912

Attention!

Turn off the electricity supply at the main circuit panel before installing. Do not connect the electricity supply until your luminaire is fully assembled and installed.

Care instructions:

Wipe with a soft dry cloth, do not use chemicals or abrasive cleaning materials.

Eichholtz B.V.

Delfweg 52

2211 VN Noordwijkerhout

The Netherlands

www.eichholtz.com service@eichholtz.com

+31 (0)252 515 850

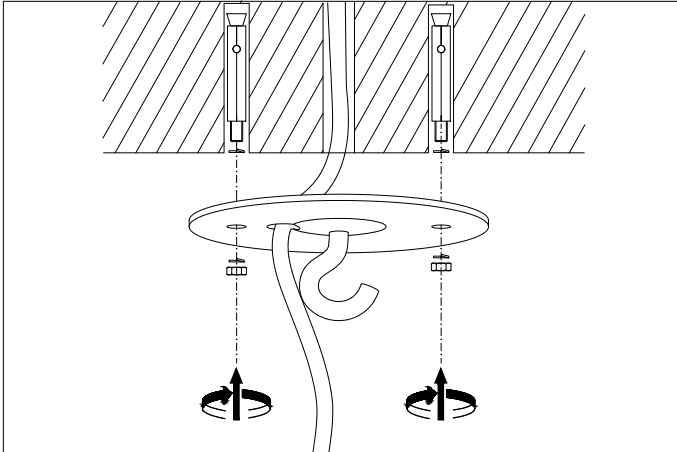

1. Fix the ceiling plate to the ceiling by using mounting plugs and screws suitable to your ceiling type. Make sure to lead the wire through the plate.

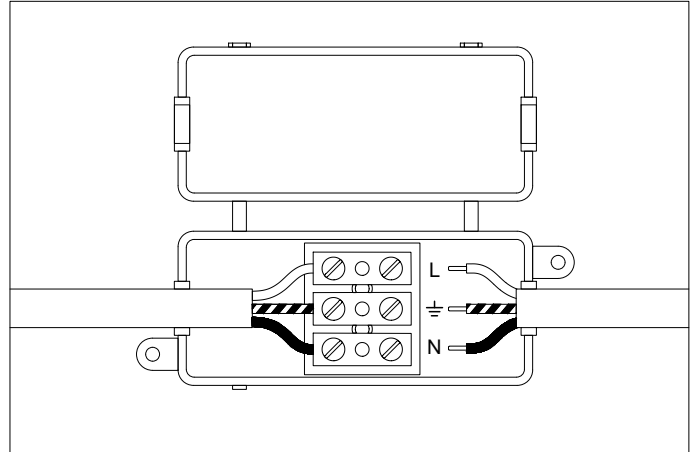

2. Connect the 3 wires according to their colours. Brown is the live wire (L), blue is the neutral wire (N), green/yellow is the earth wire (\perp).

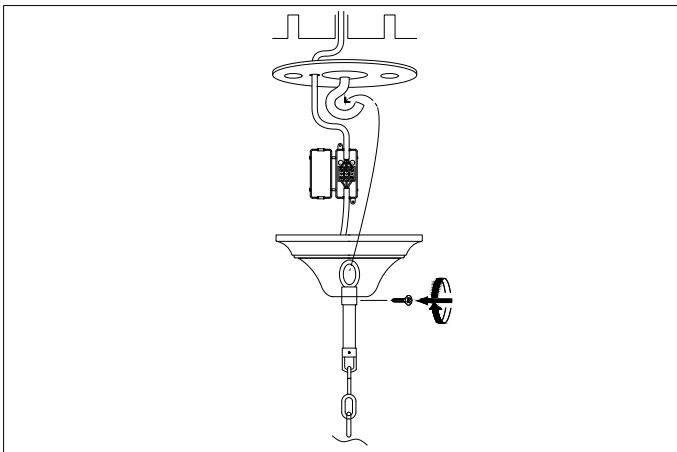

3. Place the canopy over the ceiling plate.

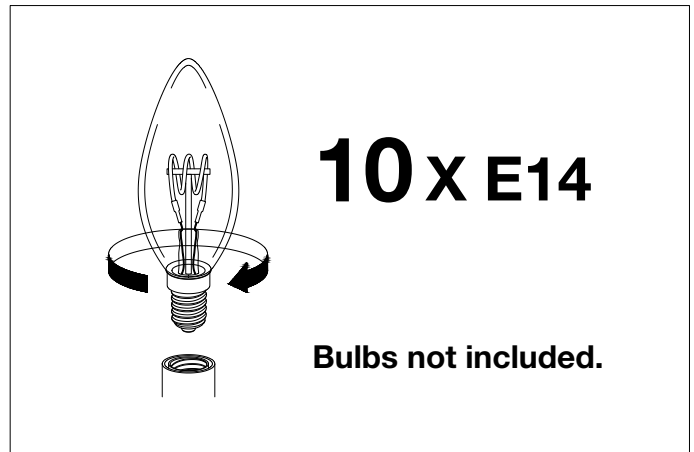

4. Place the bulbs.

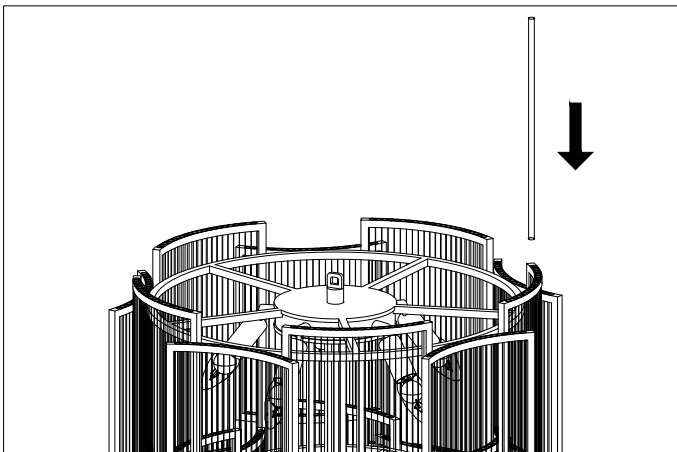

5. Place the glass tubes from the bottom row upwards.