

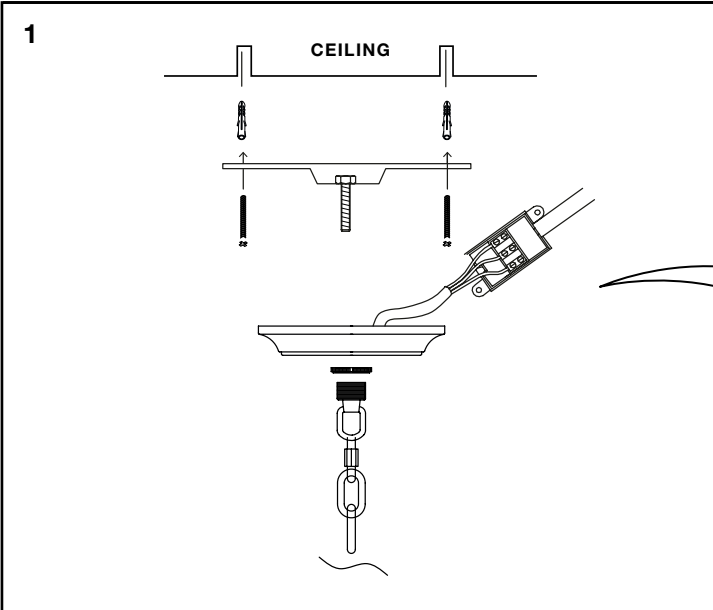

E I C H H O L T Z

111304 CHANDELIER COMMODORE

ASSEMBLY INSTRUCTION



ZOOM

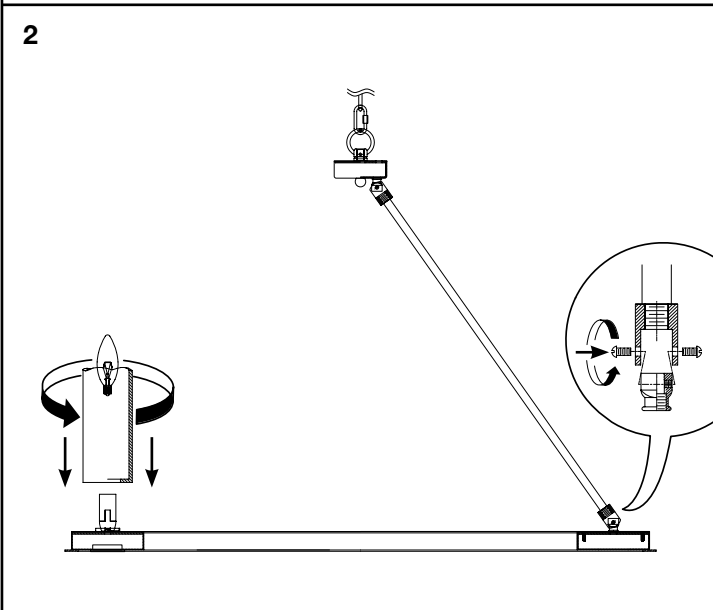
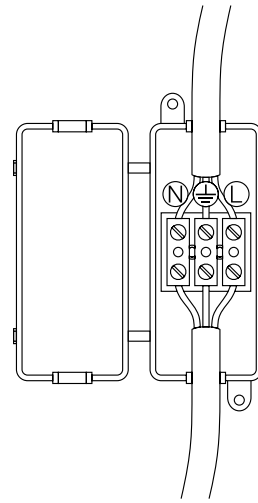

3

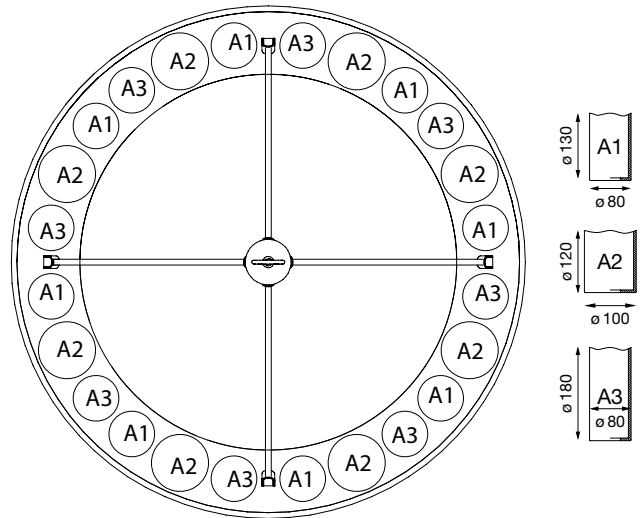

Turn off the electricity supply at the main circuit panel before installing. Do not connect the electricity supply until your luminaire is fully assembled and installed.

Fix the ceiling bracket to the ceiling by using mounting plugs and screws suitable to your ceiling type.

Connect the rods between the lamp and the top, starting with the lamp.

Place or hold the lamp in an elevated position in such a way that the wires can freely reach the ceiling junction box.

Thread the wires through the components and connect the 3 power wires according to their colours. Brown is the live wire, blue is the neutral wire, green/yellow is the earth wire.

Screw the suspension eye (with retaining nut) to the ceiling bracket and fix it securely by tightening the retaining nut.

FINAL

