

## Sea Striker Cart Assembly Instructions

1. Attach rod holders to upper frame assembly. Tighten bolts snugly. Do not over tighten.
2. Attach lower frame assembly to bottom of rod holders. Tighten bolts snugly. Do not over tighten.
3. Insert handle into handle stand. Secure using bolt with washer and lock nut. Tighten nut snugly. Do not over tighten.
4. Connect handle stand to frame assembly. Tighten nuts snugly.
5. Attach axle to lower frame assembly with U-bolts. Tighten nuts snugly. Do not over tighten. Attach wheels to axle using washer and split ring.











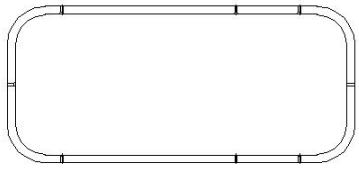
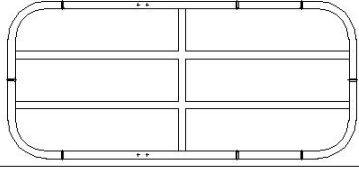

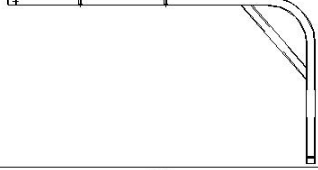
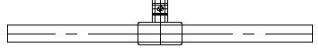
For Beach Runner Deluxe Cart:

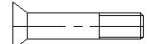
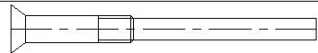
Pneumatic wheel perform best on soft sand with lower air pressure.

**NOTE: Maximum tire inflation pressure is designated on the tire sidewall. Over inflation of tires may cause serious injury. Tires are not for highway use.**

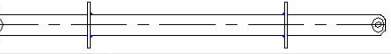
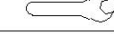
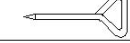

## Parts List

BR01	1PC	910*410*20	
BR02	1PC	910*410*20	
BR03	7PC	∅51*253	
BR04	1PC	720*390*20	
BR05	1PC	∅20*350	
BR06	2PC	M6*48	
BR07	2PC	M6*45	
BR08	7PC	M6*27	
BR09	7PC	M6*66.5	
BR10	1PC	M6*27	
BR11	2PC	∅2*∅30	
BR12	2PC	305*102*∅16	
BR13	1PC	∅16*∅600	
BR14	1PC	10*67	
BR15	1PC	∅5*90	
BR16	7PC	M6	
BR17	7PC	∅12*∅6.5*1	
BR18	2PC	∅30*∅16.5*2	

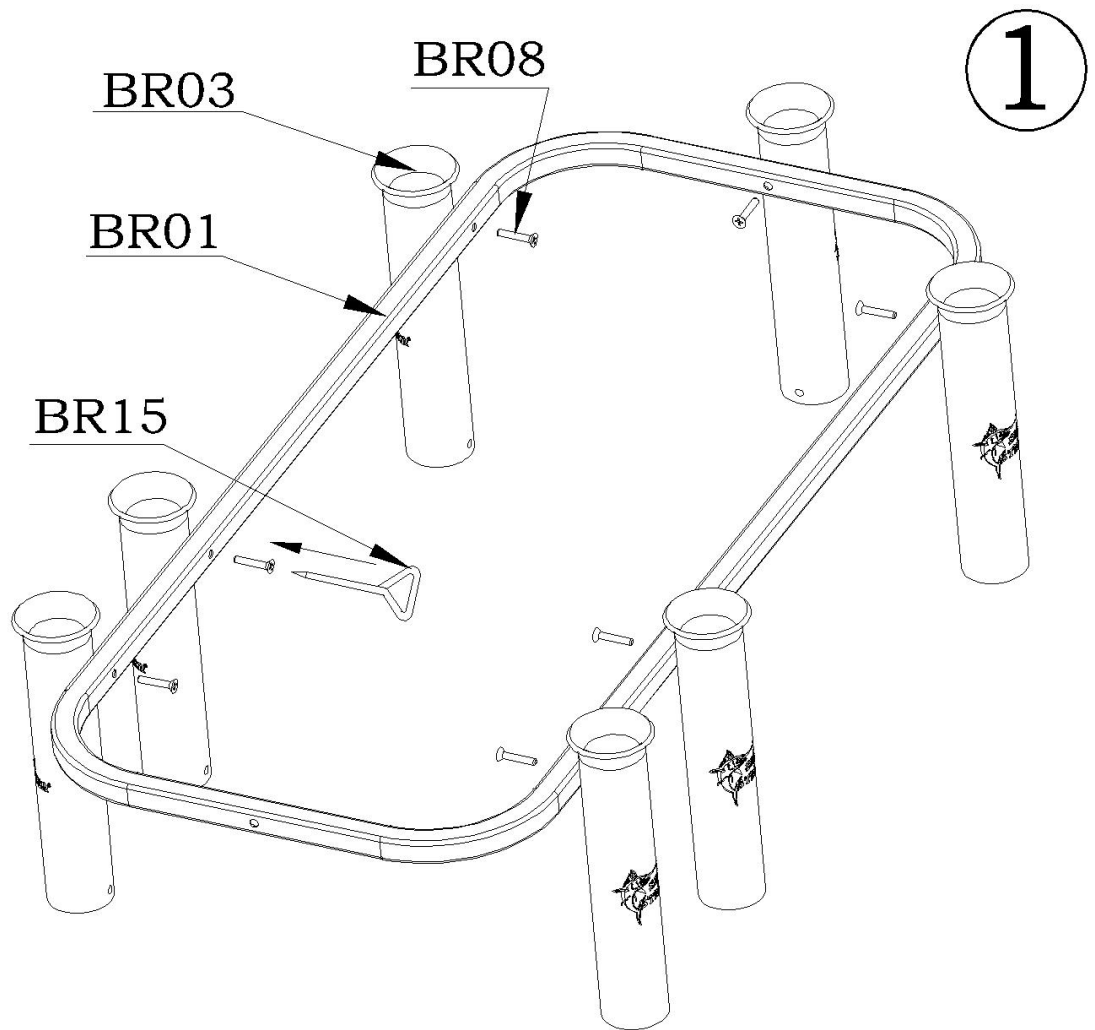

1. Attach rod holders to upper frame assembly. Tighten bolts snugly. Do not over tighten.

2

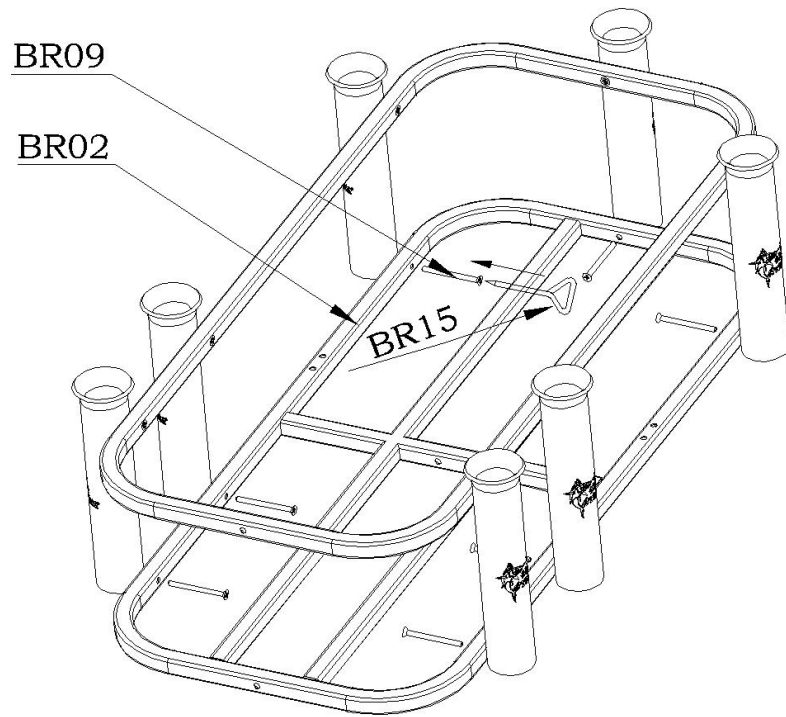

2. Attach lower frame assembly to bottom of rod holders. Tighten bolts snugly. Do not over tighten.

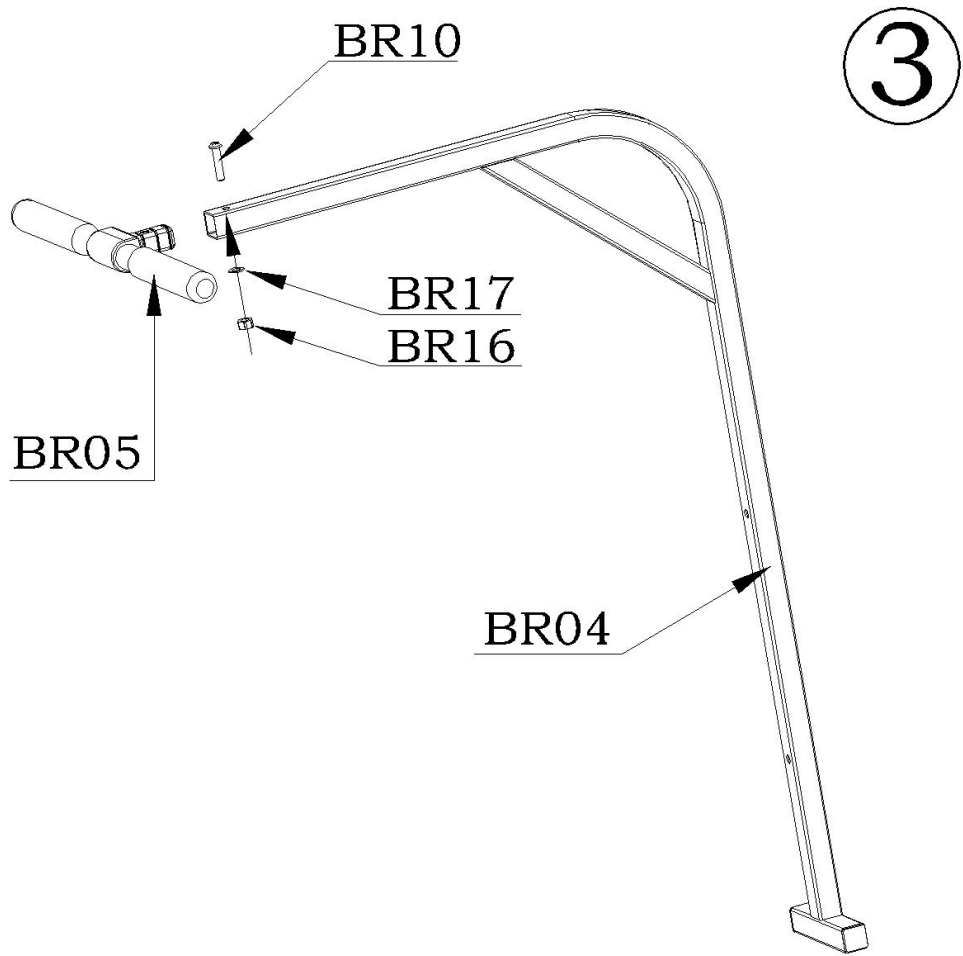

3. Insert handle into handle stand. Secure using bolt with washer and lock nut. Tighten nut snugly. Do not over tighten.

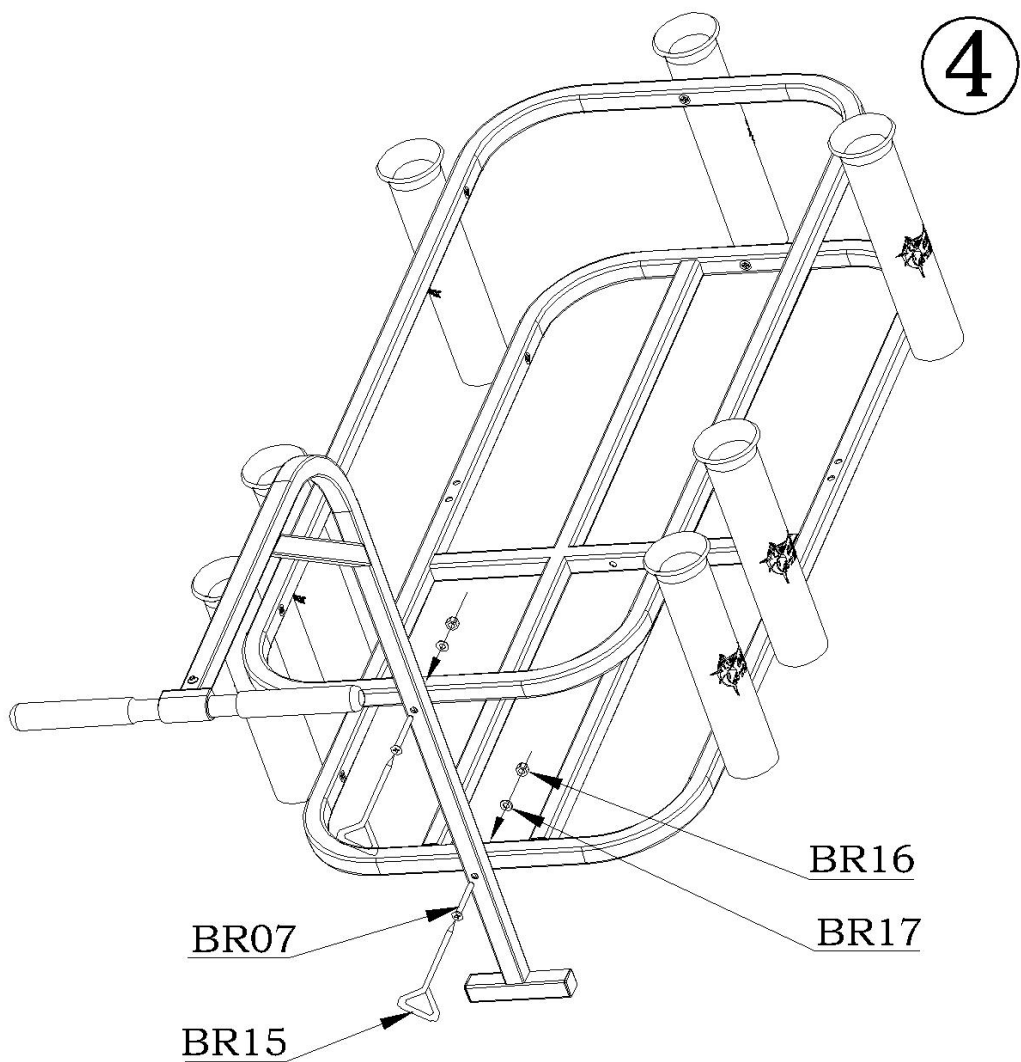

4. Connect handle stand to frame assembly. Tighten nuts snugly.

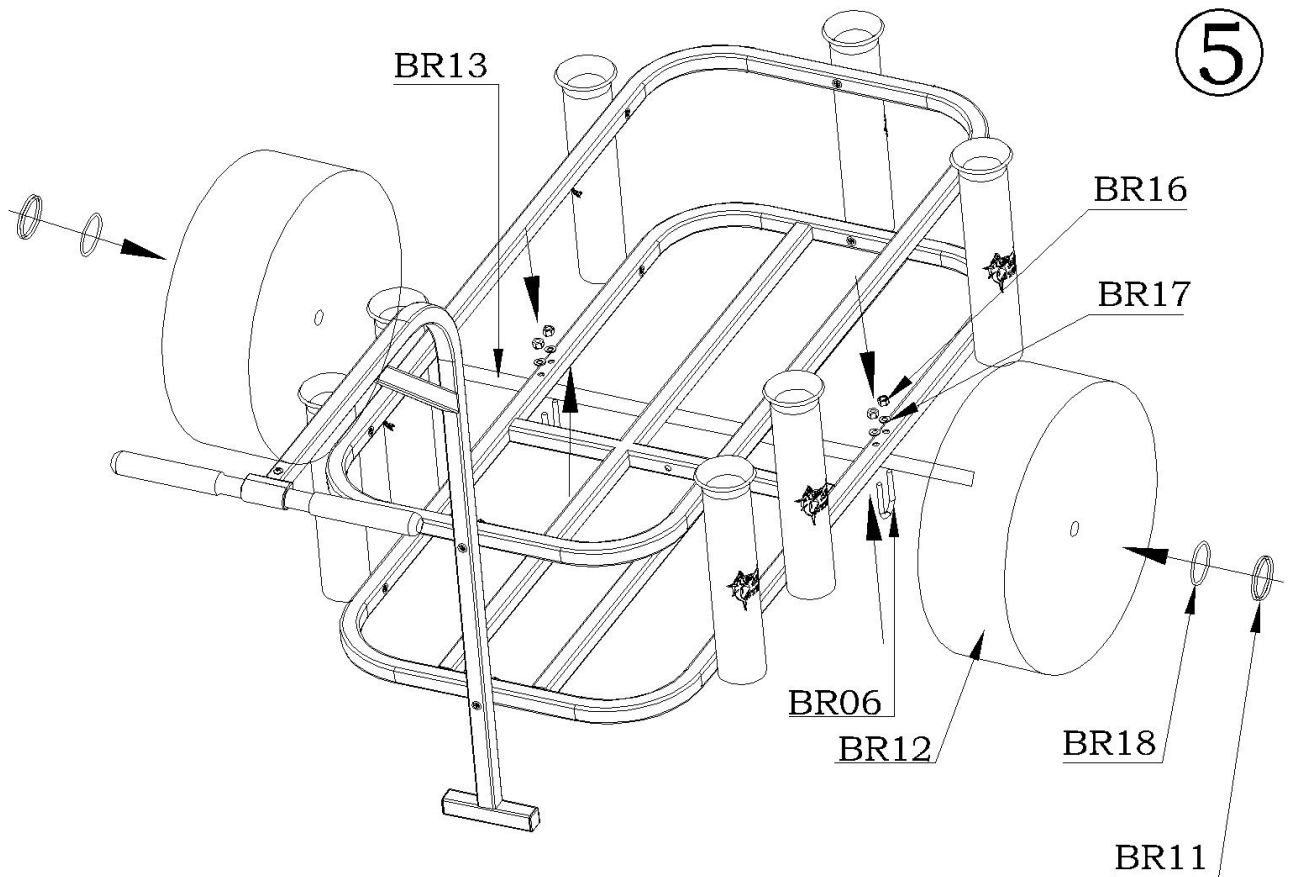

5. Attach axle to lower frame assembly with U-bolts. Tighten nuts snugly. Do not over tighten. Attach wheels to axle using washer and split ring.

For Beach Runner Deluxe Cart:

Pneumatic wheel perform best on soft sand with lower air pressure.

**NOTE: Maximum tire inflation pressure is designated on the tire sidewall. Tires are not for highway use.**



Sea Striker  
158 Little Nine Rd.  
Morehead City, NC 28557  
[www.SeaStriker.com](http://www.SeaStriker.com)