



# BTS 80 F/EMB/ FLB/BSR

# Door closer system for single- and double-leaf doors

The door closer system BTS 80 perform its function discreetly yet still meet exacting convenience and safety criteria and is suitable for doors up to 300 kg. The technique of floor spring is almost invisible placed in the ground. The BTS 80 system with its 3 model variants BTS 80 F (Floor spring for fire and smoke check doors), BTS 80 EMB (with electro-hydraulic hold open), BTS 80 FLB (with freeswing function) and the wide range of accessories allows effective adaptability to various door design and -functions. In conjunction with the doorcoordinator BSR, a use at double-leaf doors is possible.



## Contents

---

BTS 80 F/EMB/FLB/BSR	Features and functions	4
BSR	Door co-ordinator	6
BTS 80 System	Accessories	8
	Range of equipment and optional accessories	9
	Specification texts	10

---

## Wide range of functions, concealed assembly, assured quality

dormakaba floor springs offer the perfect combination between freedom of creation and greatest reliability by their concealed floor mounting, providing a multitude of functions at the same time. Just as the requirements of preventive fire protection, the desire for barrier-free usage convenience and specific functions, like electrohydraulic hold-open and free-swing, is fulfilled. Long-term engineering experience and a manufacture certified according to ISO 9001 give the certainty of an assured and high quality.

### Plus points

#### For the trade

- Complete range for every application.
- Simple stock holding thanks to identical accessories being used throughout the dormakaba BTS range.

#### For the installer

- Easy to install.
- Interchangeable spindle inserts, available to suit site conditions.
- For doors up to 300 kg in weight.

#### For the architect/specifier

- Concealed installation.
- Range of functions to suit all applications.
- Proven, robust unit – for doors weighing up to 300 kg.
- All models tested and quality assured, and approved by the Institute for Building Technology, Berlin. For CERTIFIRE approvals see certificate no. CF127 (BTS 80 F, EMB).

#### For the user

- Reliable and fail safe.
- Closing speed unaffected by changes in temperature.
- Easy door operation thanks to high mechanical efficiency.

Technical data		BTS 80 F	BTS 80 EMB	BTS 80 FLB
Closing force Size Standard doors	≤ 1100 mm	EN 4	EN 4	EN 4
	≤ 1250 mm	EN 5	EN 5	EN 5
	≤ 1400 mm	EN 6	EN 6	EN 6
Closing force Size Fire and smoke check doors	≤ 1100 mm	EN 4	EN 4	EN 4
	≤ 1250 mm	EN 5	EN 5	EN 5
	≤ 1400 mm	EN 6	EN 6	EN 6
Handed model	LH (ISO 6)	●	●	●
	RH (ISO 5)	●	●	●
	Universal	●	●	–
Closing speed variable by valve adjustment		●	●	●
Latching action variable by valve adjustment		●	●	●
Backcheck, mechanical		●	●	●
Delayed action		–	–	–
Hold-open, electro-magnetic, Hold-open point selectable between 75 and 180°		–	●	–
Free swing 0–180°		–	–	●
Weight in kg		7,1	7,7	7,7
Dimensions in mm	Length	341	341	341
	Overall depth	78	78	78
	Height	60	60	60
Power input in W		–	2,3	2,3
Operating voltage in vDC ± 15%, residual ripple max. 30%		–	24	24
Rated for continuous duty		–	100	100
Door closer tested to EN 1154		●	●	●
Hold-open devices tested to EN 1155		–	●	●
CE-marking for building products		●	●	●

● Yes – No ○ Option

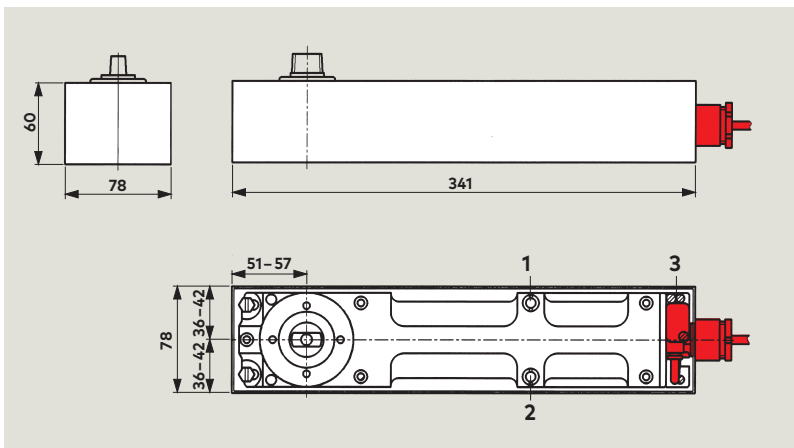

- 1 Closing speed adjustment valve
- 2 Latching speed adjustment valve  
(not available with the BTS 80 FLB)
- 3 Plug connector with cable for EMB  
and FLB power supply

## BTS 80 F

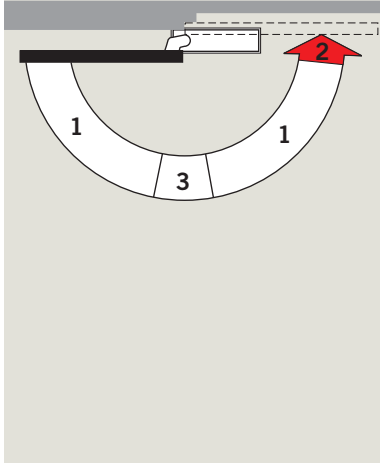

### Floor spring

- 1 Fully controlled closing with adjustable speed
- 2 Adjustable latching action
- 3 Mechanical backcheck

BTS 80 F can be used on fire and smoke check doors in both single and double action applications. For single action doors opening to 180° handed version must be used.

#### **F** Approval certification

BTS 80 F has been approved, and is subject to third-party verification, by the State Material Testing Agency (MPA), /Dortmund, Germany.

Example shows LH (ISO 6) door; mirrored arrangement applies to RH (ISO 5) door.

CERTIFIRE approved for fire doors; Cert. no. CF127



## BTS 80 EMB

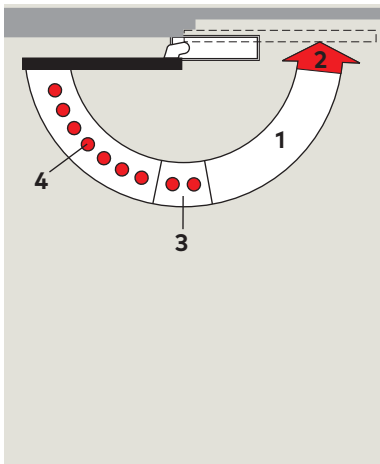

### Floor spring with electromagnetic hold-open

- 1 Fully controlled closing with adjustable speed
- 2 Adjustable latching action
- 3 Mechanical backcheck
- 4 Hold-open range (fall back approx. 3°)

BTS 80 EMB can be used on fire and smoke check doors in both single and double action applications. For single action doors opening to 180° handed version must be used.

#### **F** Approval certification

BTS 80 EMB has been approved by the Institute for Building Technology, Berlin, for use in combination with all common smoke detector systems. Acceptance inspection of the system is mandatory.

Example shows LH (ISO 6) door; mirrored arrangement applies to RH (ISO 5) door.

CERTIFIRE approved for fire doors; Cert. no. CF127



## BTS 80 FLB

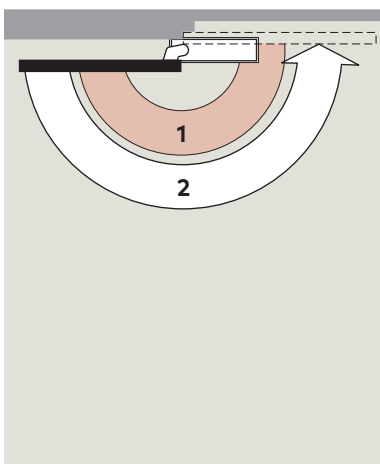

### Floor spring with free-swing feature

(electro-hydraulically controlled spring detent)

- 1 Free-swing range
- 2 Fully controlled closing in the event of an alarm or interruption of the power supply

The BTS80FLB can be used on single action fire and smoke check doors.

#### **F** Approval certification

BTS 80 FLB has been approved by the Institute for Building Technology, Berlin, for use in combination with all common smoke detector systems. Acceptance inspection of the system is mandatory.

Example shows LH (ISO 6) door; mirrored arrangement applies to RH (ISO 5) door.

CERTIFIRE approved for fire doors; Cert. no. CF127



# BSR

## Door co-ordinator

The BSR door co-ordinator ensures that, in double doors, the active leaf always closes after the inactive leaf. In the case of doors with full emergency escape hardware, the inactive leaf must be equipped with a carry bar.

## F Approval certification

BSR is approved in Germany for use in combination with double fire and smoke doors by the State Material Testing Authority, Dortmund. Further fire approvals exist or are pending in other countries. Additional approval certification of the relevant fire and smoke doors may be necessary.

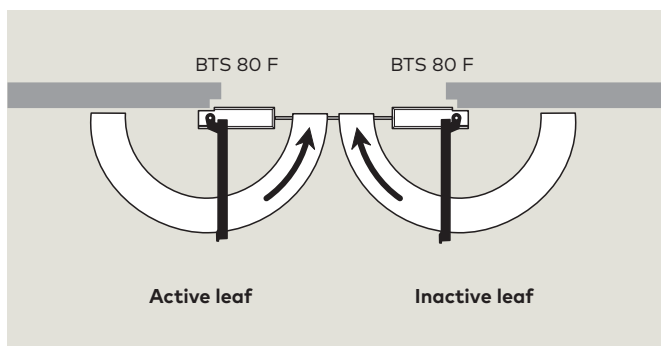
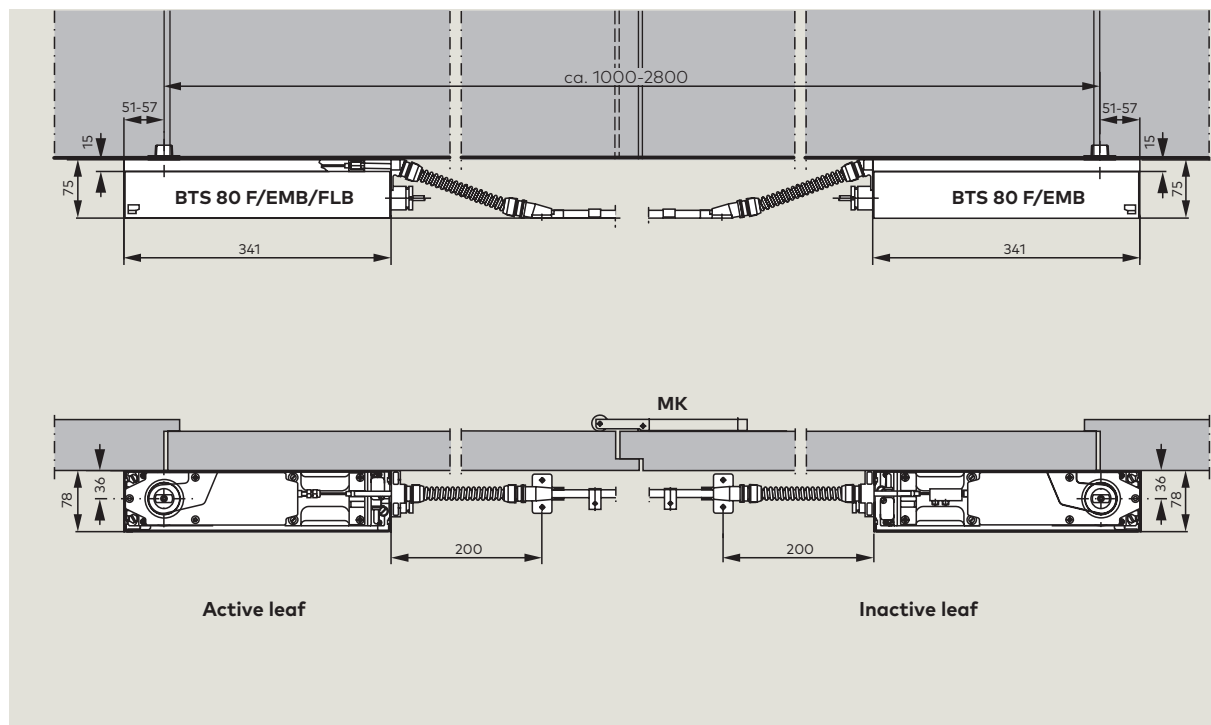

## BSR

The door co-ordinator operates independently of the hydraulics of the floor springs and consists of two mechanisms, one for the active and one for the inactive leaf, which are inter-connected by a Bowden cable.

BSR door co-ordinator is non-handed and is combined with BTS 80 F/EMB/FLB floor springs.

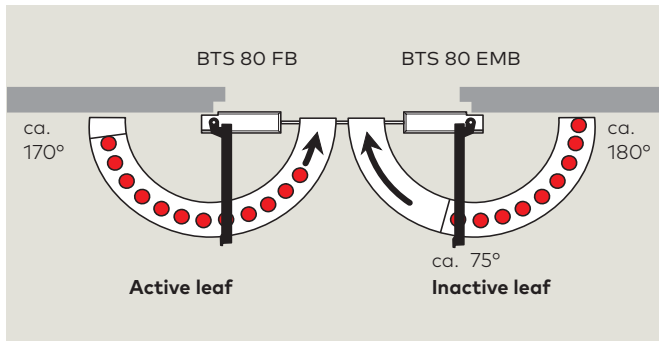

**BSR EMB 1**

With just one hold-open device for the inactive leaf, this door co-ordinator enables both door leaves to be held open.

The inactive leaf can be held open at a point between approx. 75° and 180° (fall-back approx. 3°), while the active leaf is held open by the door co-ordinator at any desired angle.

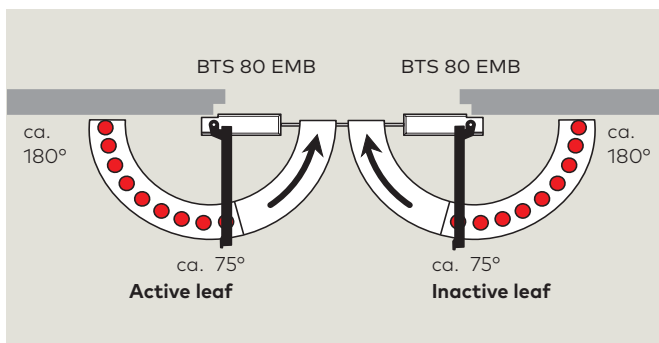

**BSR EMB 2**

With this door co-ordinator, the active leaf can be held open independently of the inactive leaf.

The hold-open points of both leaves lie between approx. 75° and 180° (fall-back approx. 3°).

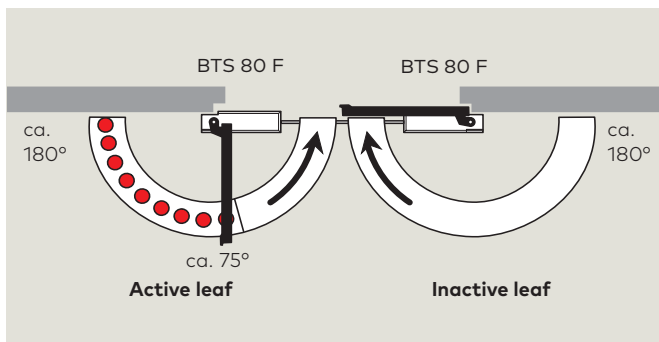

**BSR EMB 1 G**

With this door co-ordinator for special door designs incorporating, for example, fixed side panels, or a narrow inactive leaf in asymmetric double door sets, etc., the active leaf can be held open separately.

The hold-open point lies between approx. 75° and 180° (fall-back approx. 3°).

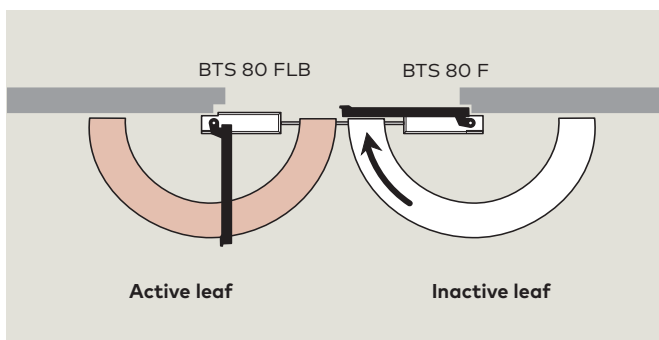

**BSR FLB 1 G**

This door co-ordinator with integral free-swing function for the active leaf can also be installed where the doors are to remain free-moving but must nevertheless close.

## Application and Installation

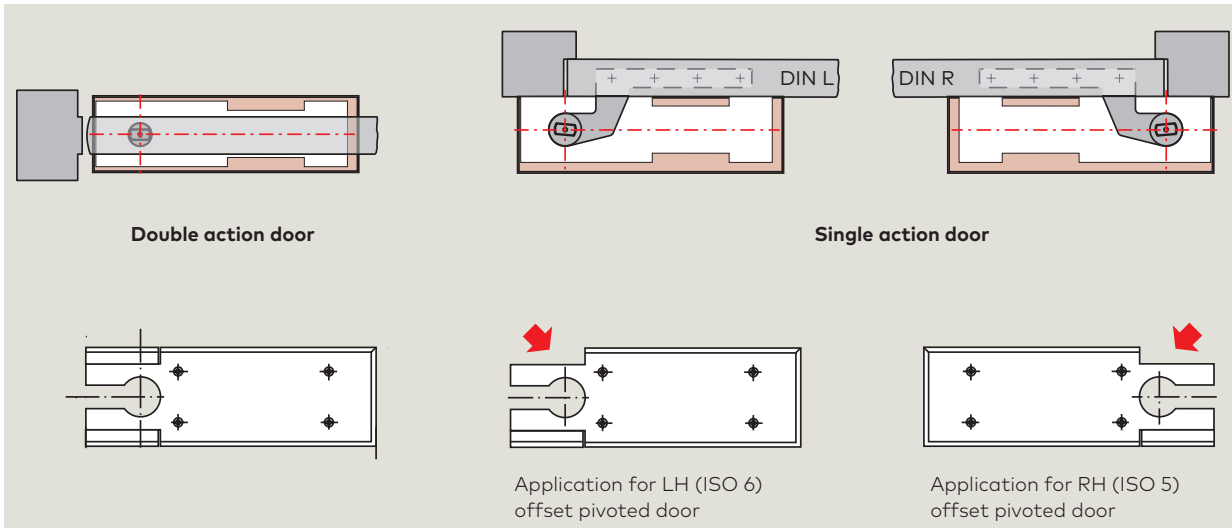

## Accessories

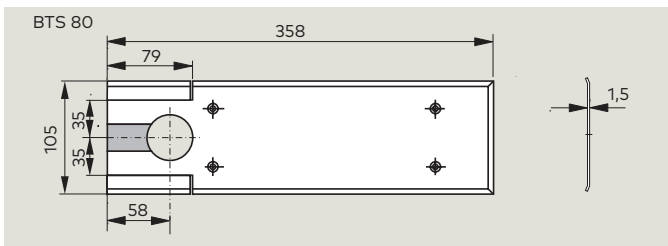

### Universal cover plate

Adaptable to right or left hand single action applications by simply snapping off the appropriate pre-blanked corner sections. For double action doors, the corner sections remain in place. The universal cover plate is available in stainless steel or satin brass (material thickness 1.5 mm).

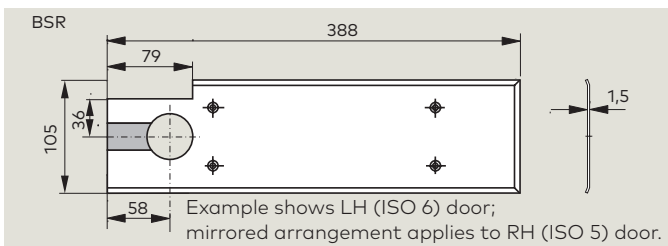

### Cover plate BSR

The cover plate in the version for LH- or RH-doors is available in stainless steel or satin brass (material thickness 1.5 mm).

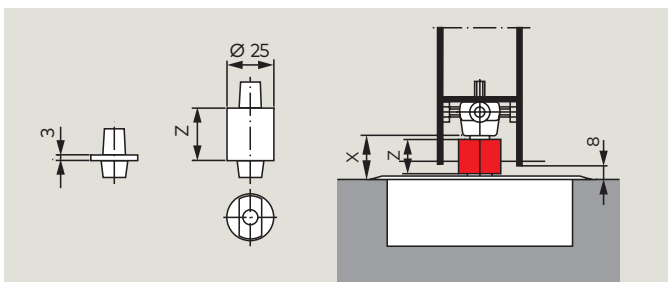

### Spindles

A range of interchangeable spindles is available to provide greater floor clearance if required (e.g. doors with thresholds, carpeted floors etc). Special spindles available on application: e.g. with flat face profile and 3° offset or square section; spindles for non dormakaba-specific accessories are also available.

Calculating the necessary length of spindle extension:  
 Extension = X - Floor clearance (normally 8 mm)  
 Collar height Z of the extended spindle inserts = Spindle extension length + 3 mm (collar height of the standard spindle insert)

### dormakaba 2300 sealing compound

For filling cavities between the floor spring body and the cement box to protect against moisture penetration. Information about other accessories such as door straps and top centres can be found in the "Accessories for dormakaba BTS Floor Springs" leaflet.

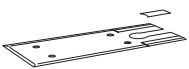

Standard equipment and accessories

Floor spring <b>BTS 80 F/EMB/FLB</b> including cement box without spindle			Spindles													Sealing compound, 2300	
			Extended spindle inserts (extension in mm)														
			normal	5	7,5	10	12,5	15	20	25	28	30	35	40	45	50	45090086
			45200401	45200402	45200403	45200404	45200419	45200405	45200406	45200407	45200414	45200408	45200409	45200410	45200411	45200412	
<b>BTS 80 F</b>																	
EN 4	LH (ISO 6) RH (ISO 5) Universal	80220101 80220201 80220001	△	△	△	△	△	△	△	△	△	△	△	△	△	△	△
EN 5	LH (ISO 6) RH (ISO 5) Universal	80210101 80210201 80210001	△	△	△	△	△	△	△	△	△	△	△	△	△	△	△
EN 6	LH (ISO 6) RH (ISO 5) Universal	80230101 80230201 80230001	△	△	△	△	△	△	△	△	△	△	△	△	△	△	△
<b>BTS 80 EMB</b>																	
EN 4	LH (ISO 6) RH (ISO 5) Universal	82224101 82224201 82224001	△	△	△	△	△	△	△	△	△	△	△	△	△	△	△
EN 5	LH (ISO 6) RH (ISO 5) Universal	82214101 82214201 82214001	△	△	△	△	△	△	△	△	△	△	△	△	△	△	△
EN 6	LH (ISO 6) RH (ISO 5) Universal	82234101 82234201 82234001	△	△	△	△	△	△	△	△	△	△	△	△	△	△	△
<b>BTS 80 FLB</b>																	
EN 4	LH (ISO 6) RH (ISO 5)	82124101 82124201	△	△	△	△	△	△	△	△	△	△	△	△	△	△	△
EN 5	LH (ISO 6) RH (ISO 5)	82114101 82114201	△	△	△	△	△	△	△	△	△	△	△	△	△	△	△
EN 6	LH (ISO 6) RH (ISO 5)	82134101 82134201	△	△	△	△	△	△	△	△	△	△	△	△	△	△	△
<b>Universal cover plate</b>																	
Stainless steel	46700000																△
Satin brass	46700100																

Door co-ordinator BSR		Floor spring			Spindles			Cover Plates	
					Extension in mm			LH (ISO 6)	
					normal	5	25	Stainless steel Satin brass	
					45200470	45200471	45200477	46700080 46700280	
								RH (ISO 5)	
								Stainless steel Satin brass	
								46700081 46700281	
Variant	45700900	BTS 80 F	BTS 80 EMB	BTS 80 FLB					
BSR	1 x	2 x							
BSR-EMB 1	1 x	1 x	1 x						
BSR-EMB 2	1 x		2 x						
BSR-EMB 1 G	1 x	1 x	1 x		△ 2 x	△ 2 x	△ 2 x		△ 1 x LH 1 x RH
BSR-FLB 1 G	1 x	1 x		1 x					

△ Accessory

## specification text

### BTS 80 F

Floor spring to En 1154, with CE mark, with fully hydraulic control of the closing action from 180°, adjustable latching action and backcheck. Including cement box.

#### Size

- EN 4
- EN 5
- EN 6

#### Model

- LH (ISO 6)
- RH (ISO 5)
- Universal

#### Accessories

- Universal cover plate (1.5 mm thick)
  - Stainless steel
  - Satin brass
- Spindle
  - standard
  - . . . mm extension
- Sealing compound

#### Make:

dormakaba BTS 80 F

### BTS 80 EMB

Floor spring to En 1154, with CE mark, with electro-hydraulic hold-open, to En 1155 and integrated pressure compensation for constant, adjustable, temperature-immune hold-open between door opening angles of approx. 75° and 180°. With adjustable closing speed under full hydraulic control, adjustable latching action and backcheck. Including cement box. operating voltage: 24vDC power input: 2.3 W Approved by the german Institute for Building Technology, Berlin, for use in hold-open systems. Acceptance inspection of the system is mandatory.

#### Size

- EN 4
- EN 5
- EN 6

#### Model

- LH (ISO 6)
- RH (ISO 5)
- Universal

#### Accessories

- Universal cover plate (1.5 mm thick)
  - Stainless steel
  - Satin brass
- Spindle
  - Standard
  - . . . mm extension
- Sealing compound

#### Make:

dormakaba BTS 80 EMB

### BTS 80 FLB

Floor spring to En 1154, with CE mark, with electro-hydraulic free-swing function to En 1155 between door opening angles of 0° and 180°, closer function (non-powered) effective from 180°, and with backcheck (non-powered). Including cement box. operating voltage: 24vDC power input: 2.3 W Approved by the german Institute for Building Technology, Berlin, for use in hold-open systems. Acceptance inspection of the system is mandatory.

#### Size

- EN 4
- EN 5
- EN 6

#### Model

- LH (ISO 6)
- H (ISO 5)

#### Accessories

- Universal cover plate (1.5 mm thick)
  - Stainless steel
  - Satin brass
- Spindle
  - Standard
  - . . . mm extension
- Sealing compound

#### Make:

dormakaba BTS 80 FLB

### BTS 80 BSR

Floor spring to En 1154, with CE mark, with fully hydraulic control of the closing action from 180°, adjustable latching action, backcheck and door coordination function conforming to En 1158, operating independently of the closer hydraulics, comprising an active leaf and an inactive leaf mechanism interconnected by a bowden cable. Including cement box, non-handed.

#### Size

- EN 4
- EN 5
- EN 6

#### Accessories

- Universal cover plate (1.5 mm thick)
  - Stainless steel
  - Satin brass
- Spindle
  - Standard
  - . . . mm extension
- Sealing compound

#### Make:

dormakaba BTS 80 BSR

**BTS 80 BSR-EMB 1**

Floor spring to En 1154, with CE mark, with electro-hydraulic hold-open to En 1155 at the inactive leaf and integrated pressure compensation for constant, adjustable, temperature immune hold-open between door opening angles of approx. 75° and 180°. With adjustable closing speed under full hydraulic control, adjustable latching action, backcheck and door co-ordination function conforming to En 1158, operating independently of the closer hydraulics, comprising an active leaf and an inactive leaf mechanism interconnected by a bowden cable. Including cement box, non-handed.

Operating voltage: 24 V DC

Power input: 2.3 W

Approved by the german Institute for Building Technology, Berlin, for use in hold-open systems. Acceptance inspection of the system is mandatory.

**Size**

- EN 4
- EN 5
- EN 6

**Accessories**

- Cover plates (1,5 mm thick)
  - Stainless steel
  - Satin brass
- Spindle
  - Standard
  - . . . mm extension
- Sealing compound

**Make:**

dormakaba BTS 80 BSR-EMB 1

**BTS 80 BSR-EMB 2**

Floor spring to En 1154, with CE mark, with electro-hydraulic hold-open to En 1155 at the inactive and active leaf and integrated pressure compensation for constant, adjustable, temperature-immune hold-open between door opening angles of approx. 75° and 180°. With adjustable closing speed under full hydraulic control, adjustable latching action, backcheck and door co-ordination function conforming to En 1158, operating independently of the closer hydraulics, comprising an active leaf and an inactive leaf mechanism interconnected by a bowden cable. Including cement box, non-handed.

Operating voltage: 24 V DC

Power input: 4.6 W

Approved by the german Institute for Building Technology, Berlin, for use in hold-open systems. Acceptance inspection of the system is mandatory.

**Size**

- EN 4
- EN 5
- EN 6

**Accessories**

- Cover plates (1,5 mm thick)
  - Stainless steel
  - Satin brass
- Spindle
  - Standard
  - . . . mm extension
- Sealing compound

**Make:**

dormakaba BTS 80 BSR-EMB 2

**BTS 80 BSR-EMB 1G**

Floor spring to En 1154, with CE mark, with electro-hydraulic hold-open to En 1155 at the active leaf and integrated pressure compensation for constant, adjustable, temperature immune hold-open between door opening angles of approx. 75° and 180°. With adjustable closing speed under full hydraulic control, adjustable latching action, backcheck and door coordination function conforming to En 1158, operating independently of the closer hydraulics, comprising an active leaf and an inactive leaf mechanism interconnected by a bowden cable. Including cement box, non-handed.

Operating voltage: 24vDC

Power input: 2.3 W

Approved by the german Institute for Building Technology, Berlin, for use in hold-open systems. Acceptance inspection of the system is mandatory.

**Size**

- EN 4
- EN 5
- EN 6

**Accessories**

- Cover plates (1,5 mm thick)
  - Stainless steel
  - Satin brass
- Spindle
  - Standard
  - . . . mm extension
- Sealing compound

**Make:**

dormakaba BTS 80 BSR-EMB 1G

**BTS 80 BSR-FLB 1G**

Floor spring to En 1154, with CE mark, with electro-hydraulic free-swing function at the active leaf between door opening angles of approx. 0° and 180°, closer function (non-powered) effective from 180°; with backcheck (non-powered) and door co-ordination function conforming to En 1158, operating independently of the closer hydraulics, comprising an active leaf and an inactive leaf mechanism interconnected by a bowden cable. Including cement box, non-handed.

Operating voltage: 24vDC

Power input: 2.3 W

Approved by the german Institute for Building Technology, Berlin, for use in hold-open systems. Acceptance inspection of the system is mandatory.

**Size**

- EN 4
- EN 5
- EN 6

**Accessories**

- Cover plates (1,5 mm thick)
  - Stainless steel
  - Satin brass
- Spindle
  - Standard
  - . . . mm extension
- Sealing compound

**Make:**

dormakaba BTS 80 BSR-FLB 1G

# Our products



## Mechanical Key Systems

Systems that enable access rights and key control to all rooms within the premises

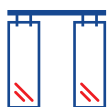

## Interior Glass Systems

System solutions made from glass for a wide range of everyday and office applications



## Lodging Systems

Hotel locks and locking systems as well as access management solutions for holiday homes



## Electronic Access & Data

Electronic access control and workforce management for efficient access management, security and data collection



## Door Hardware

Solutions for residential or commercial projects



## Entrance Systems

Automated access solutions for convenient access to buildings



## Safe Locks

Security locks for preventing unauthorized access to goods, valuables, information or hazardous substances



## Services

Tailor-made services and customized maintenance for long-term functional integrity of access and security solutions

