

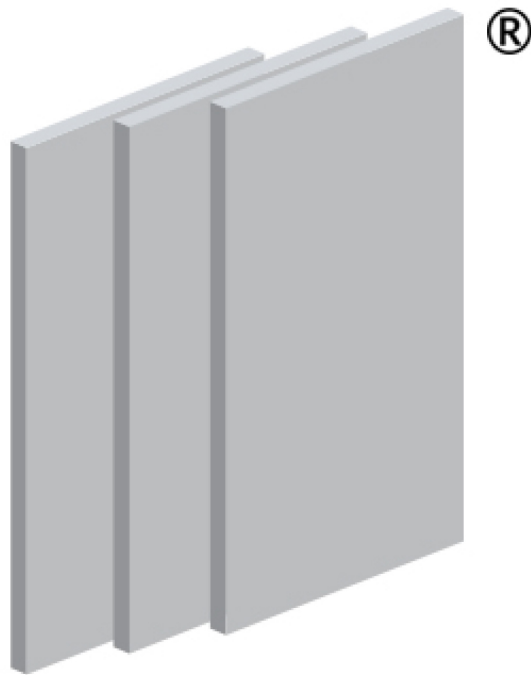

**Trade, DIY, Bulk**



**T H R U**  
**S L I D E**  
S L I D I N G  
D O O R S

For any of our white, walnut and coloured doors we supply the pelmet and frame in white primed MDF for painting but on occasion it may be white paper overlay MDF for painting.

All content and images are copyright protected by DirectDoors.com  
Intellectual Property Office Trademark  
No: UK00003288492



DOOR CONFIGURATION	DOOR WIDTH OPTIONS	OVERALL WIDTH WITHOUT FRAME	OVERALL WIDTH INCLUDING FRAME	OVERALL HEIGHT WITHOUT FRAME	OVERALL HEIGHT INCLUDING FRAME
2 DOOR	686mm	1352mm	1412mm	2056mm	2086mm
2 DOOR	762mm	1504mm	1564mm	2056mm	2086mm
2 DOOR	838mm	1656mm	1716mm	2056mm	2086mm
3 DOOR	686mm	2018mm	2078mm	2056mm	2086mm
3 DOOR	762mm	2246mm	2306mm	2056mm	2086mm
3 DOOR	838mm	2474mm	2534mm	2056mm	2086mm
4 DOOR	686mm	2704mm	2764mm	2056mm	2086mm
4 DOOR	762mm	3008mm	3068mm	2056mm	2086mm
4 DOOR	838mm	3312mm	3372mm	2056mm	2086mm

## IMPORTANT

Please note: You can only assemble these door configurations by using the frame provided. Your warranty will be invalid if other alternatives are used.

All loads are taken by the top track to ensure smooth, light operation and long life.

Prior to installing this doorset, inspect for damage and do not proceed to fit if any noticeable damage or defect is evident. This doorset should be stored in a dry flat location before installation.



Thank you for purchasing one of our Thruslide products, in this PDF we take you step by step on how to assemble and install your new product. We will also go through the list of tools required to do so.

All Thruslide door products are cut to size upon receipt of order and cannot be cancelled afterwards, they are classed as a bespoke item created and manufactured by DirectDoors.com to suit your chosen door dimensions. Please ensure you have a reliable joiner / builder to carry out the following works and ensure that they have a well ventilated area if cutting.

## TOOLS REQUIRED

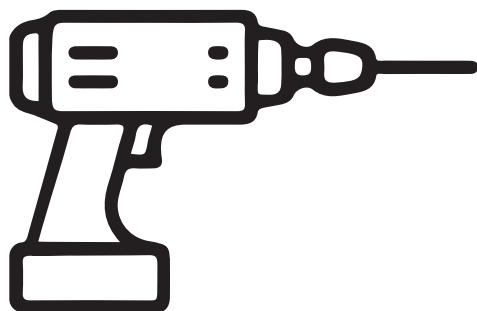

Cordless Power Drill - Drill Bits



3mm Steel Drill Bit (this is required for pilot holes through the MDF frame)



Countersink bit (this is to allow screw heads to go below surface of frame at pilot holes)

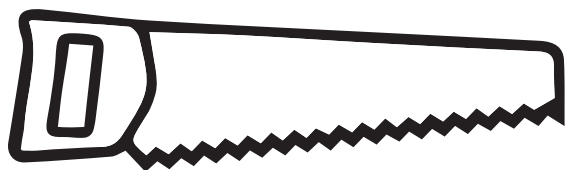

Hand Saw



Tape Measure



Masonry Bit (only required if it's not a timber stud wall you're fixing to)



Spirit Level



Please note that the following materials are supplied with the Thruframes:



Frame screw assembly fixings (this is for fixing the lintel and threshold to the legs and pelmet to the lintol).

Please note that the following materials are **NOT** supplied with the Thruframes:

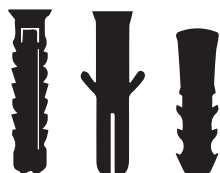

Wall screw fixings and masonry plugs: these are very dependent on whether the wall is "stud" timber frame or brick etc, stud walls do not require masonry plugs



Filler

# COMPONENT LIST



## 2 DOOR SYSTEM

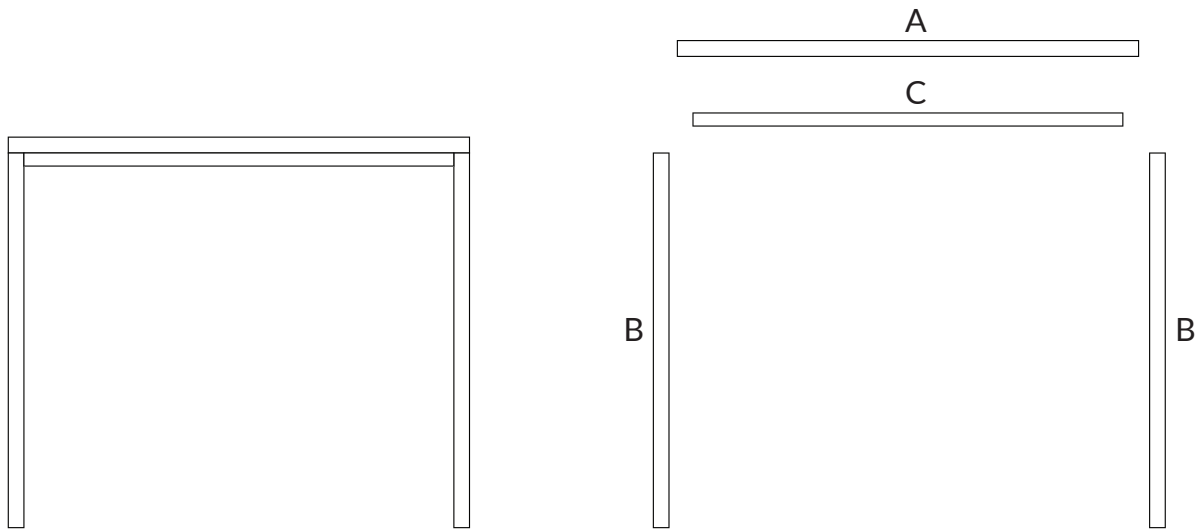

	LINTOL PLATE	A - x1
	FRAME SIDE/LEG PLATE	B - x2
	PELMET PLATE	C - x2

Lintol and pelmet plate widths are variable depending on the size chosen.

FRAME SCREW		x5
PELMET PLATE SCREW		x8

The items below will be delivered from our preferred track supplier:

ALUMINIUM TRACK		x2
ALUMINIUM CHANNEL		x2
TRACK STOP		x4
WHEEL HANGER		x4
SOFT CLOSER		x4
RATTLE PROOF GUIDE		x2



Not to scale, dimensions will vary depending on the option chosen.

# COMPONENT LIST



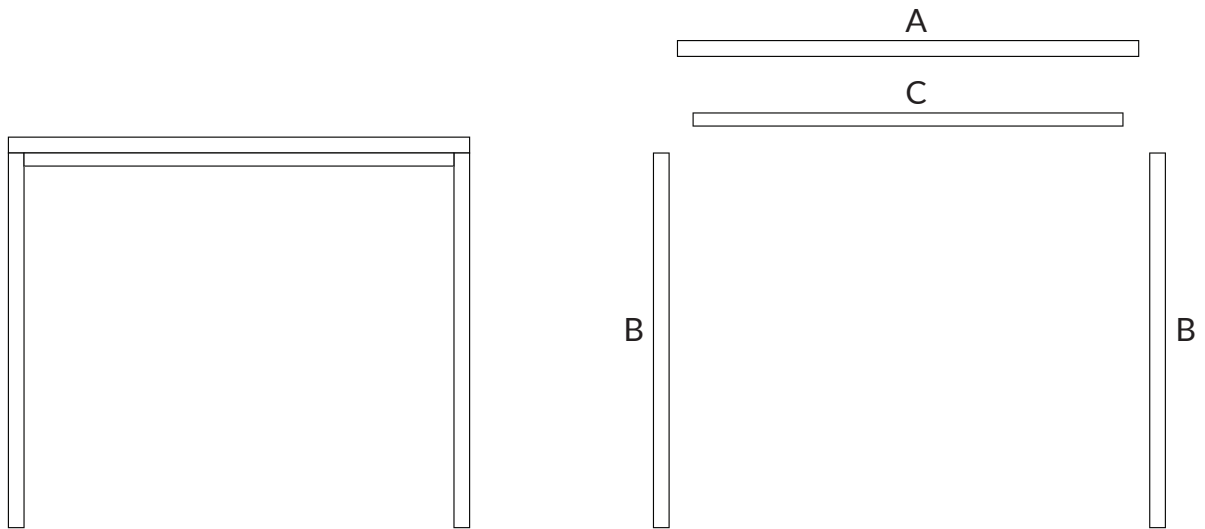

## 3 DOOR SYSTEM









-  LINTOL PLATE A - x1
-  FRAME SIDE/LEG PLATE B - x2
-  PELMET PLATE C - x2

Lintol and pelmet plate widths are variable depending on the size chosen.

- FRAME SCREW  x5
- PELMET PLATE SCREW  x10

The items below will be delivered from our preferred track supplier:

- ALUMINIUM TRACK  x3
- ALUMINIUM CHANNEL  x3
- TRACK STOP  x6
- WHEEL HANGER  x6
- SOFT CLOSER  x3
- RATTLE PROOF GUIDE  x3



Not to scale, dimensions will vary depending on the option chosen.

# COMPONENT LIST



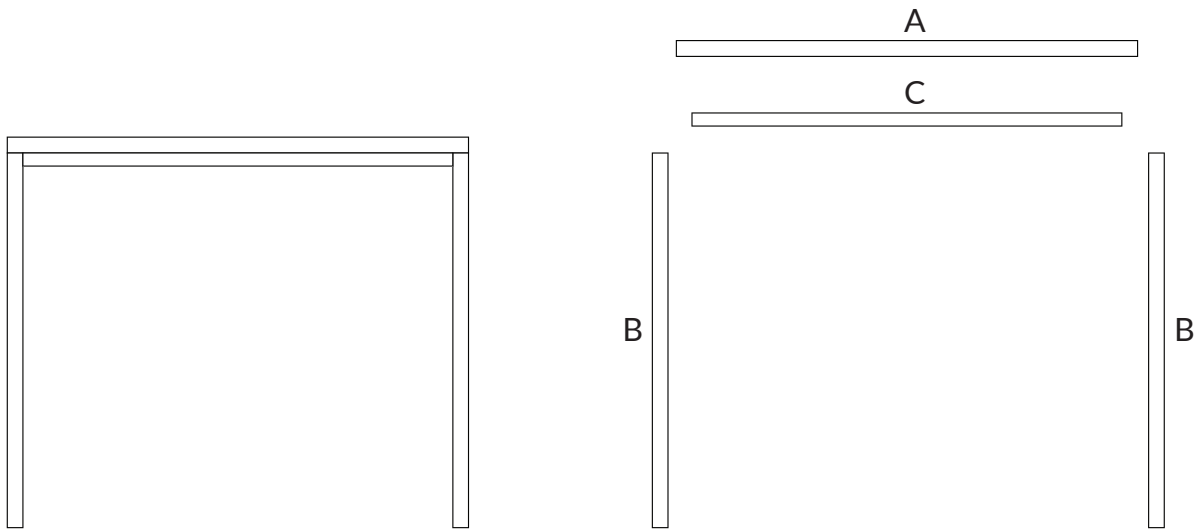

## 4 DOOR SYSTEM









-  LINTOL PLATE A - x1
-  FRAME SIDE/LEG PLATE B - x2
-  PELMET PLATE C - x2

Lintol and pelmet plate widths are variable depending on the size chosen.

- FRAME SCREW  x5
- PELMET PLATE SCREW  x12

The items below will be delivered from our preferred track supplier:

- ALUMINIUM TRACK  x4
- ALUMINIUM CHANNEL  x4
- TRACK STOP  x8
- WHEEL HANGER  x8
- SOFT CLOSER  x4
- RATTLE PROOF GUIDE  x4

Not to scale, dimensions will vary depending on the option chosen.



Frame Legs and Lintol may be longer then required.

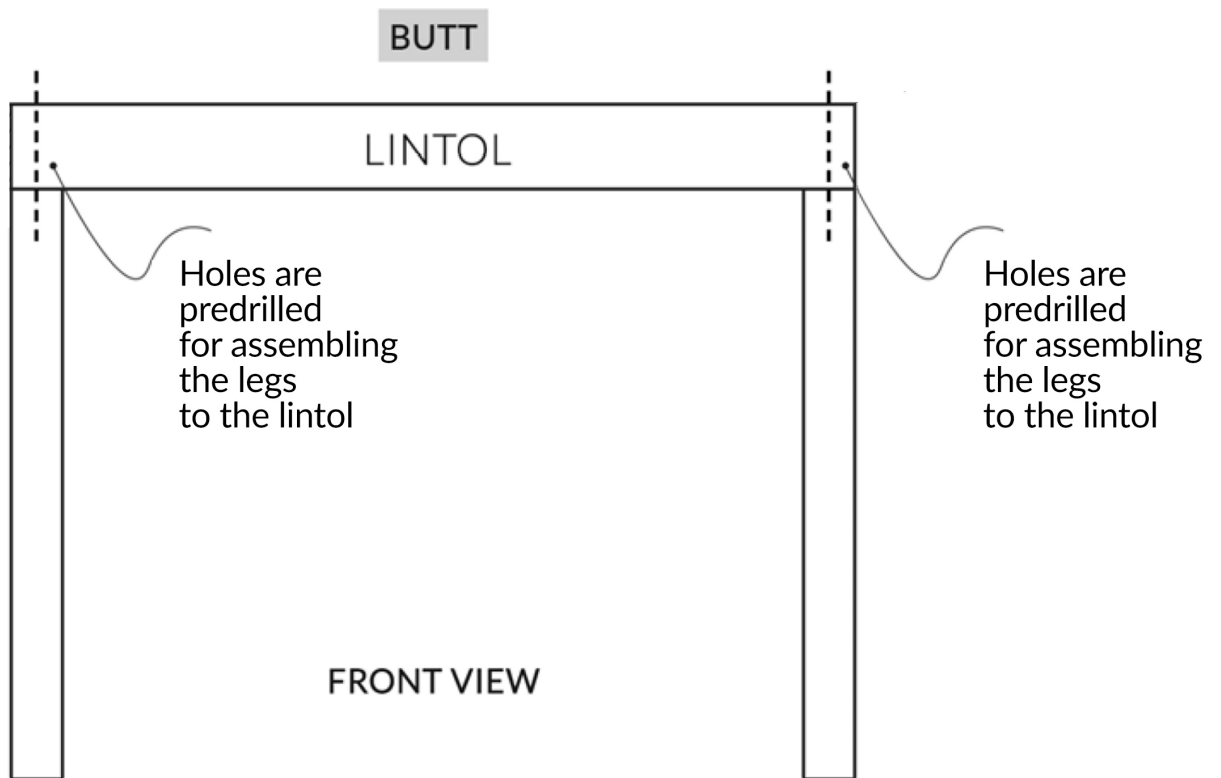

FRAME MUST BE PERFECTLY ALIGNED ON ALL THREE AXIS

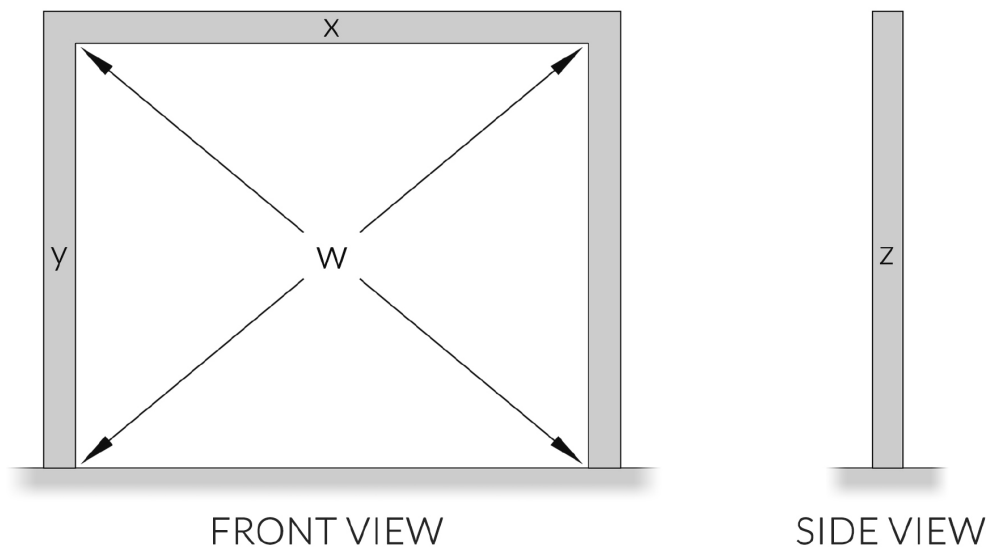

X: horizontal. Y: vertical. Z: lateral = all must be true  
 W = must be perfectly symmetrical/square

## 2 Door Set With 20mm Overlap Viewed From Above

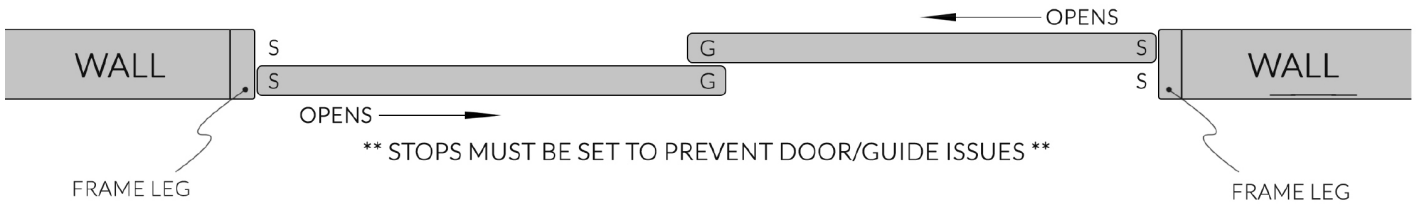

## 3 Door Set With 20mm Overlap of Each Central Door Edge Viewed From Above

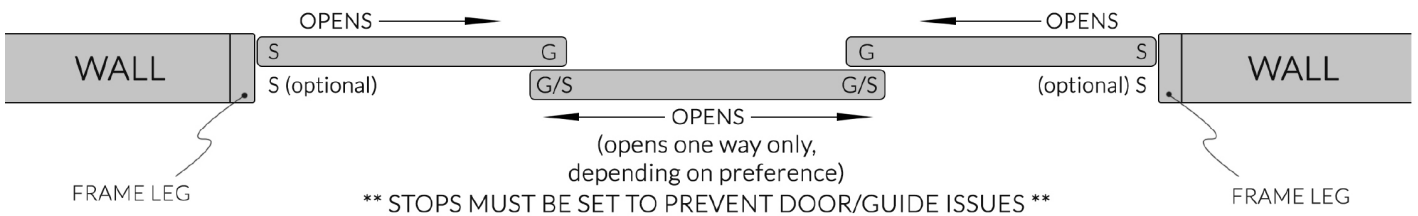

## 4 Door Set With 20mm Overlap of One (L/R) Edge of Each Central Door Edge Viewed From Above

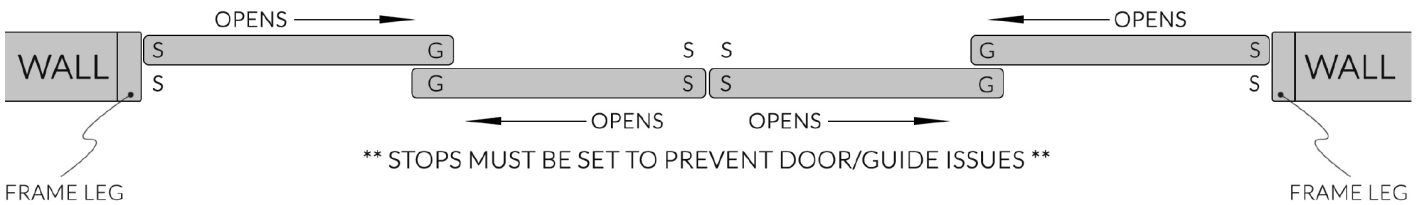

KEY: S = Track Stops  
G = Floor Guides

# TRACK ARRANGEMENT ON FRAME ASSEMBLY



\*\* ALL DIMENSIONS ARE APPROXIMATE \*\*

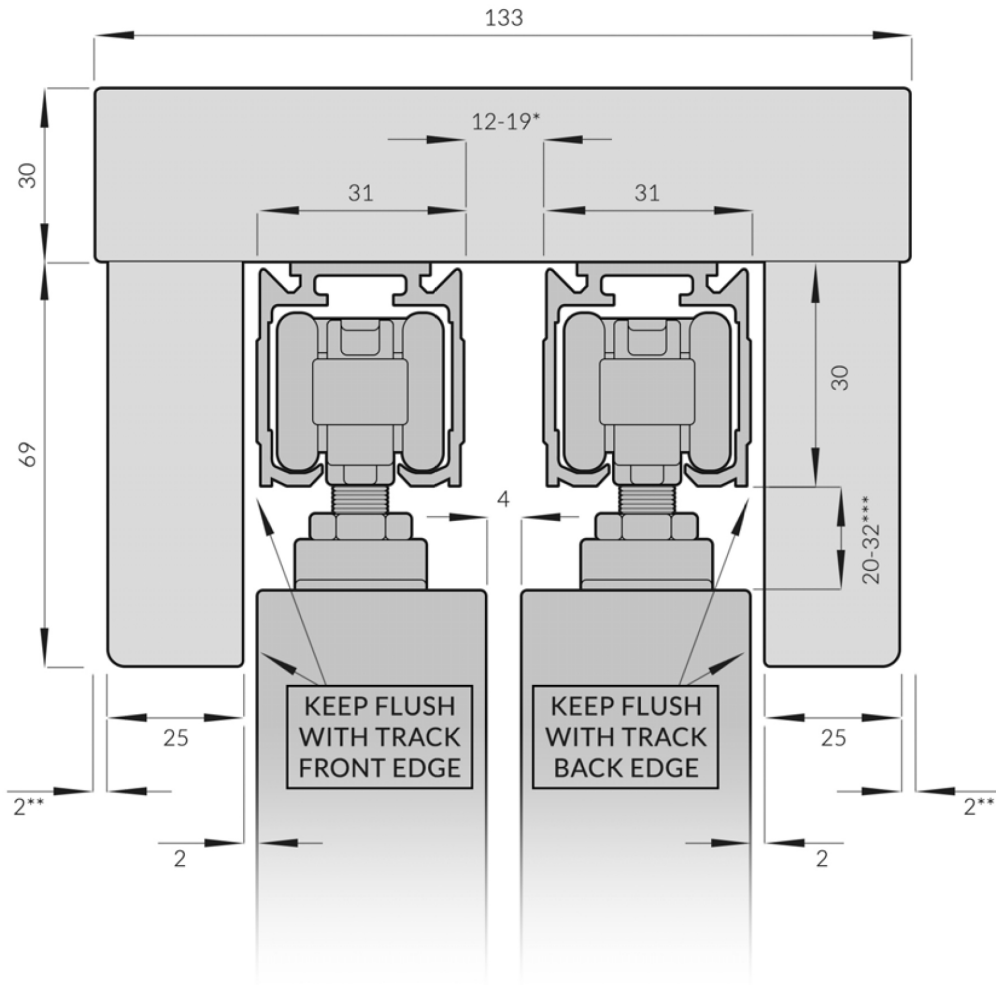

- 12-19\*** If using glazed doors that feature protruding beads, the gap between tracks should be increased.
- 2-4\*\*** Any increase to the gap between tracks may require the pelmet to move closer to the edge of the lintol (choice dependant).
- 20-32\*\*\*** This measurement is adjustable, depending on required door height and/or floor level.

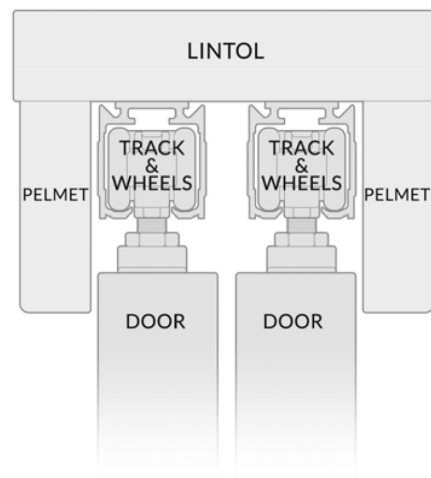
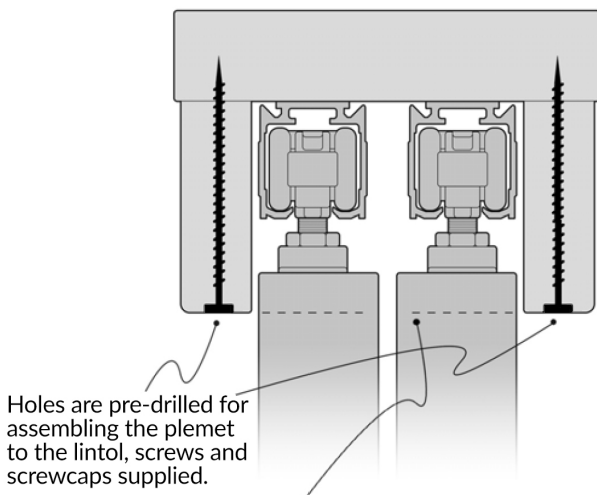

NOTE: The amount the pelmet covers the door by is dependant on what clearance you give between top of door and track.



SINGLE TRACK SHOWN FOR GUIDANCE PURPOSES ONLY

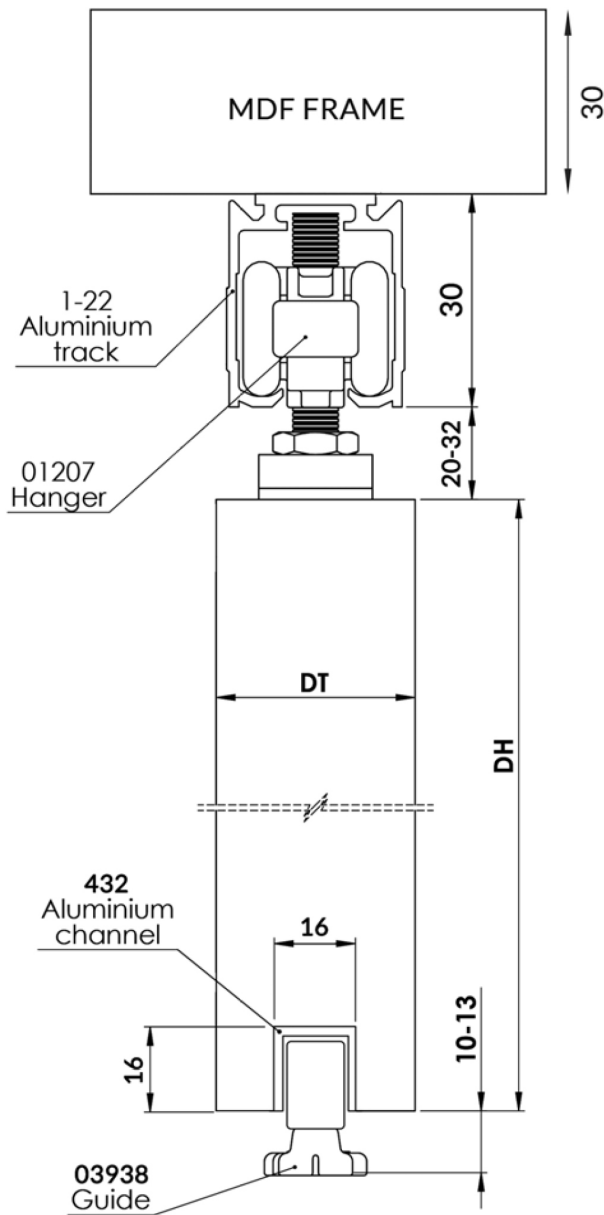

DT: Door Thickness  
 DH: Door Height  
 DWi: Door Width

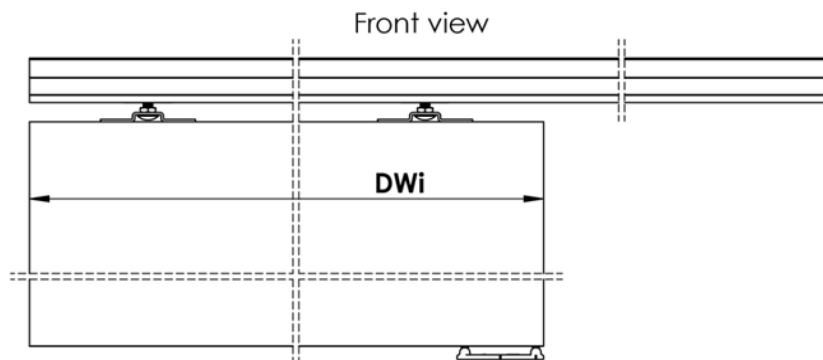

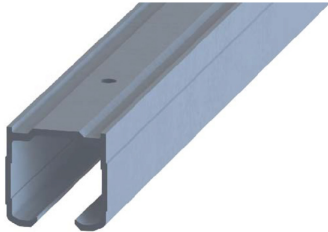

ANODISED ALUMINIUM TOP TRACK, 2 LENGTHS



TRACK STOP  
(QUANTITY VARIABLE DEPENDANT ON CONFIGURATION)



WHEELS AND HANGERS  
(QUANTITY VARIABLE DEPENDANT ON CONFIGURATION)



CONCEALED SOFT CLOSER 100kg (MAX)  
1 PER DOOR

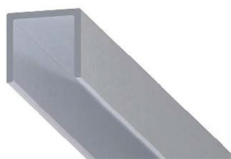

ALUMINIUM CHANNEL, 1 LENGTH  
REQUIRES CUTTING TO SUIT EACH DOOR WIDTH.  
(FOR FITTING INTO THE UNDERSIDE ROUTERED  
GROOVE OF DOOR, **NOT TO THE FLOOR**)



ADJUSTABLE RATTLE PROOF GUIDE 13mm ROLLER  
(QUANTITY VARIABLE DEPENDANT ON CONFIGURATION)

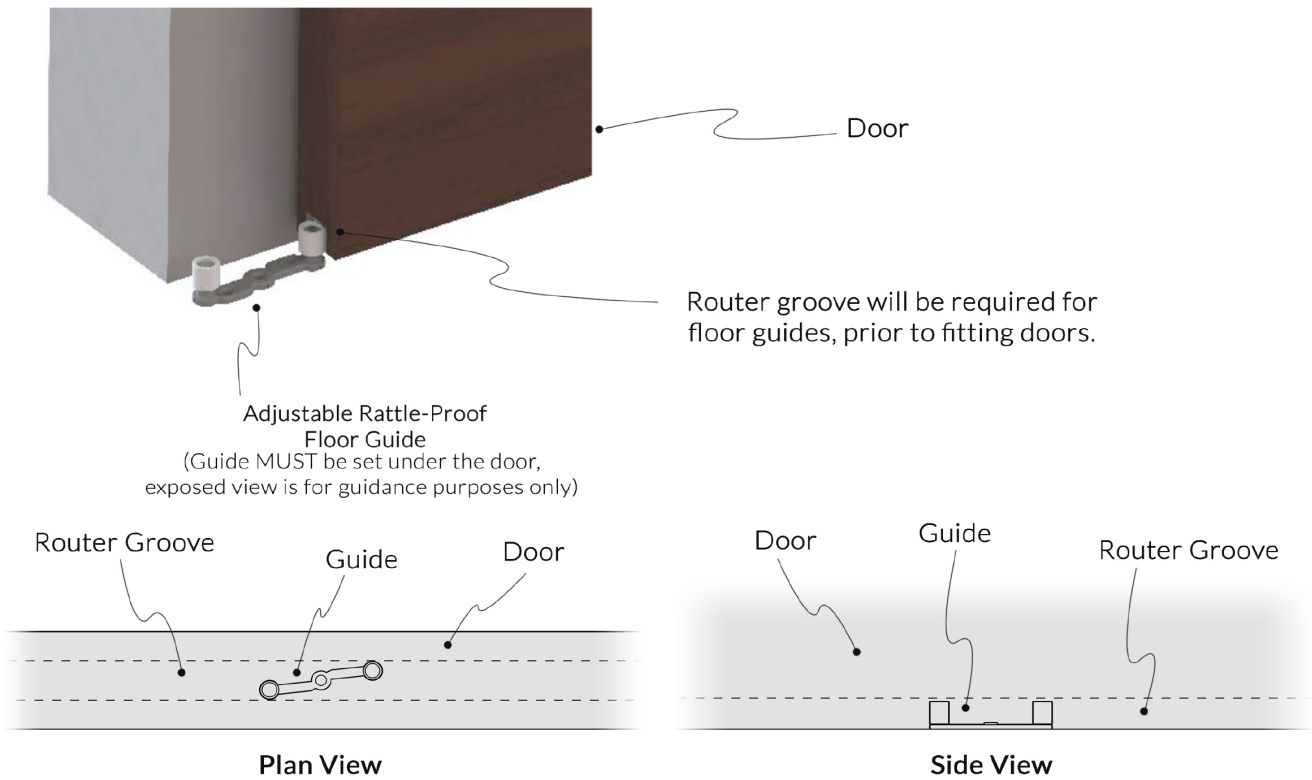

NOTE: Images are for indication purposes only - Product styles and dimensions may vary slightly.

# CONCEALED SOFT CLOSER KIT

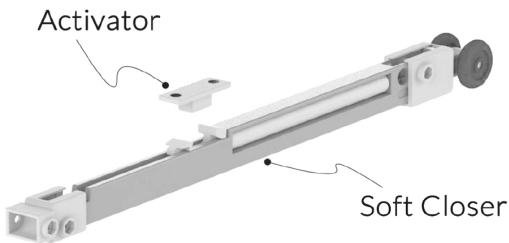

The Soft-Closer kit is fitted within the sliding door assembly track, where it is concealed from view. The mechanism provides a soft and smooth closing operation to the door assembly.

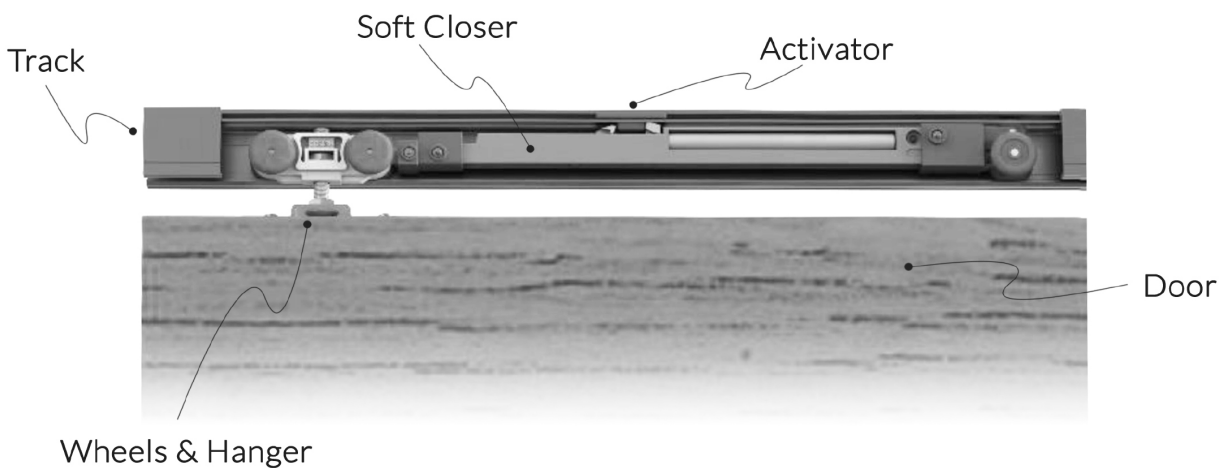

## Step 1 Preparing track



Minimum track length must be 2 x door width (DW).  
Place track on a flat surface and cut it to required length.

## Step 2 Preparing hanger

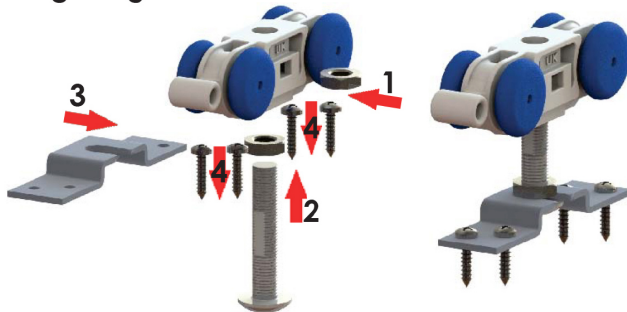

Slide wheel into track before fixing track between frame legs.

Hanger for timber doors (pair)

## Step 3

### Fixing track

### Soffit fixing

Pre-drill  $\phi 5.2$  holes for easier installation

Dimension 'd' must be between 275 and 300

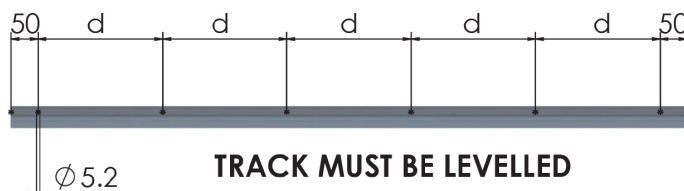



## Step 4 Components layout

\*Refer to the fitting instructions for the **Soft Closer**.

\*\*Slide the **Soft Closer** into track before fixing track to lintol between frame legs - see separate instructions on next pages.

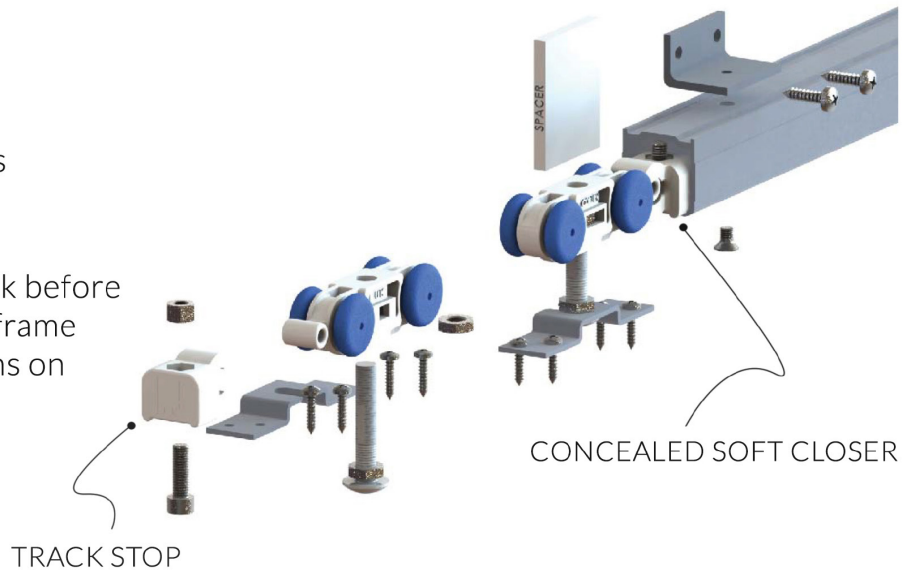

## Step 5 Preparing the door



For timber doors:

Mark the proper position of the hanger plates on top of the door and fix them with screws

## Step 6 Door installation



Insert the door panel and adjust it vertically.

Ensure that the door panel is square, level and plumb

## Step 7 Bottom guide installation



03938 - ADJUSTABLE RATTLE PROOF, 13mm ROLLER

Adjustable Rattle-Proof Floor Guide  
(Guide MUST be set under the door, exposed view is for guidance purposes only)



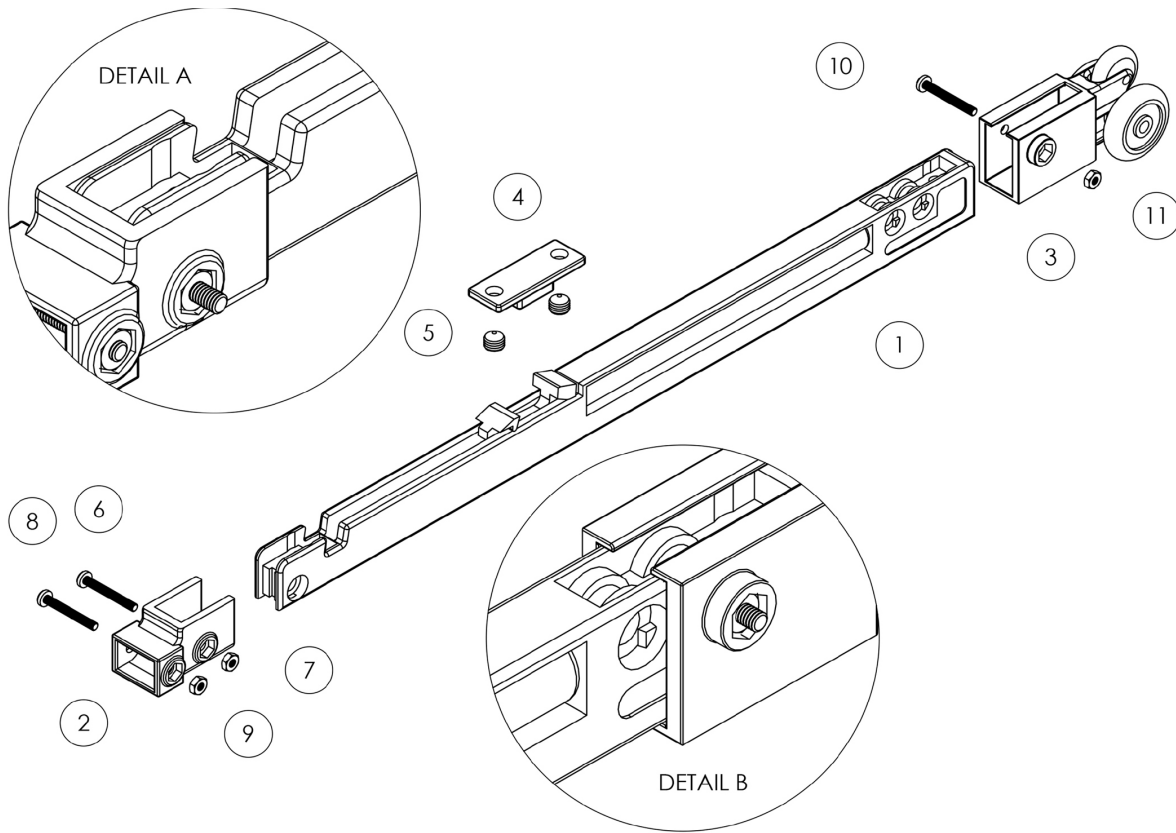

30637 – CONCEALED SOFT CLOSER KIT

## Step 1 Attach soft closer to hanger

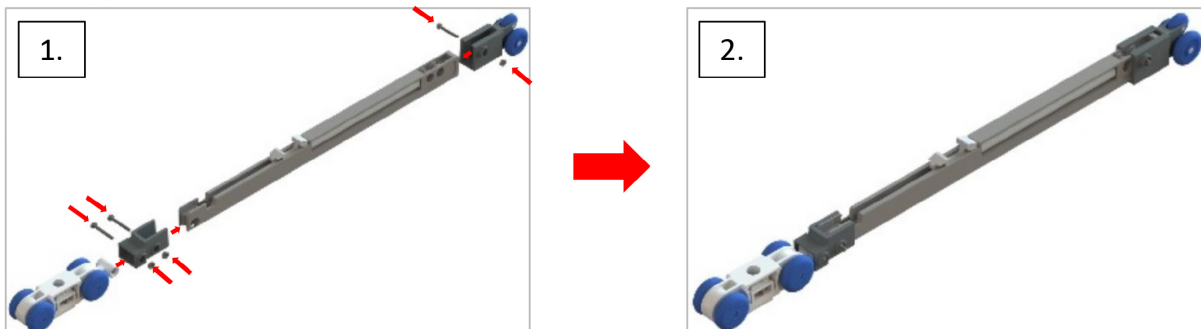

Attach 3-wheeler to the back of the soft closer. Attach adaptor to other side of soft closer, afterwards attach hanger to adaptor (1.).



## Step 2 Insert actuator and soft closer

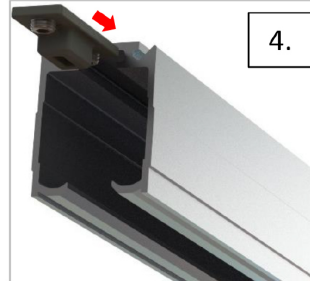
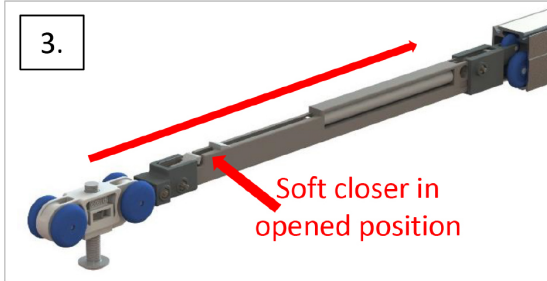

Make sure soft closer trigger is in open position, then insert soft closer inside track (3.) and then insert actuator in the track (4). Attach door onto hangers.

Measure distance from edge of door to centre of pendant bolt (D) and add 140mm for actuator location

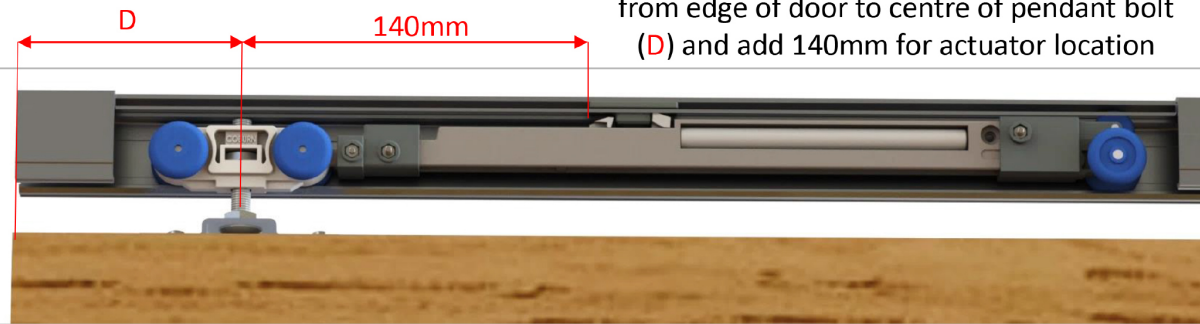

## Step 3 (OPTIONAL) Soft opening

Repeat steps 1 and 2 for soft opening



All content and images are copyright protected by DirectDoors.com