



ThruSlide
ECO
URBAN





Space-Saving Luxury

Upgrade your home decor with our exclusive range of Handmade Sliding Doors crafted using sustainably sourced European solid laminated timber.

Our Eco-Urban Sliding doors are designed to save space while adding a luxurious touch to your interiors. Available in both standard and bespoke sizes, our doors are tailored to meet your individual needs and preferences, making them the perfect addition to your stylish and sophisticated interiors.

Six Premium Primed Colours: Stylish Single and Double Sliding Doors

Introducing our latest Thru-Slide Urban Heritage sliding door range, inspired by the Industrial and Loft style décor, featuring numerous styles that use panels and different glass styles combined with bold lines and geometric profiles to create an ultra-contemporary aesthetic.

Our Eco-Urban sliding doors are available in both single and double configurations, with a range of panelled and glazed styles in clear, frosted, designer and tinted glass options. You can choose from six premium primed colours: Cloud White, Mist Grey, Stormy Grey, Shadow Black, Heather Blue and Sage Sky. Not sure which colour to choose? We offer samples of all four colours so you can colour match in the comfort of your own home.



THRU-SLIDE Eco-Urban Doors: Thickness, Stiles & Rails, Core

Rails and Stiles are 90mm* Astragals are all nominal 34mm*.

These heavily dowel jointed solid laminated wood doors are **40mm* thick** and are designed to meet the most demanding quality requirements. Eco-Urban are **British made** industrial style doors, made of sustainable, fast growing solid laminated timber .

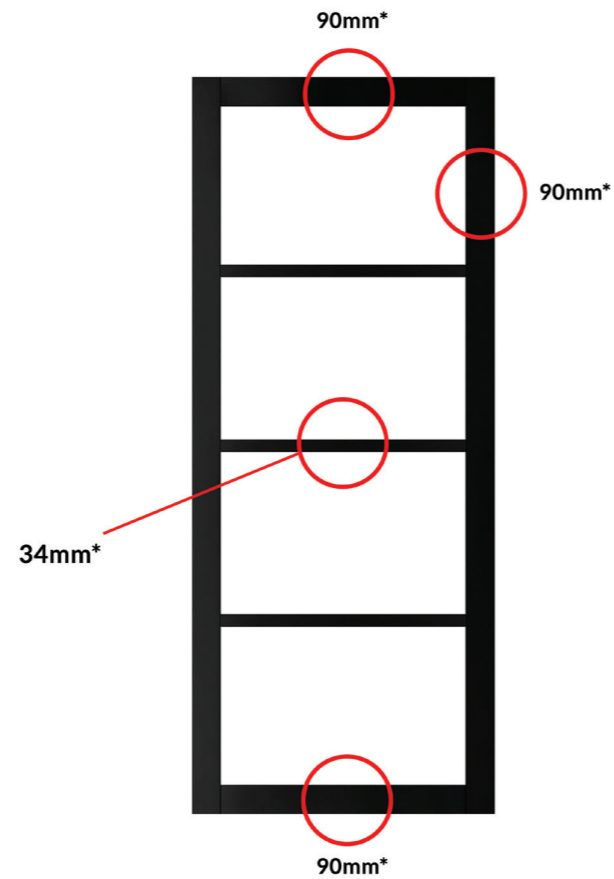

*All dimensions and thicknesses are +/- 2mm.

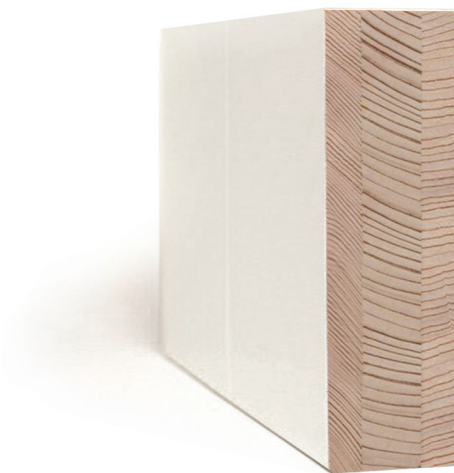

The supplier of our **solid laminated core** timber for the Eco-Urban door range guarantee the wood is responsibly sourced and 100% FSC compliant.

Door stiles, rails and astragal materials are an Eco sustainable solid laminated timber in what is known as a laminated construction, this is when thick sections of timber are laminated to provide a product stronger and more stable than an individual timber section and all from FSC registered and managed forests, door panels are always 9mm thick moisture resistant MDF.

THRU-SLIDE Eco-Urban Doors: Colour, Finish

Six Premium Primed Colour Options - Samples available.

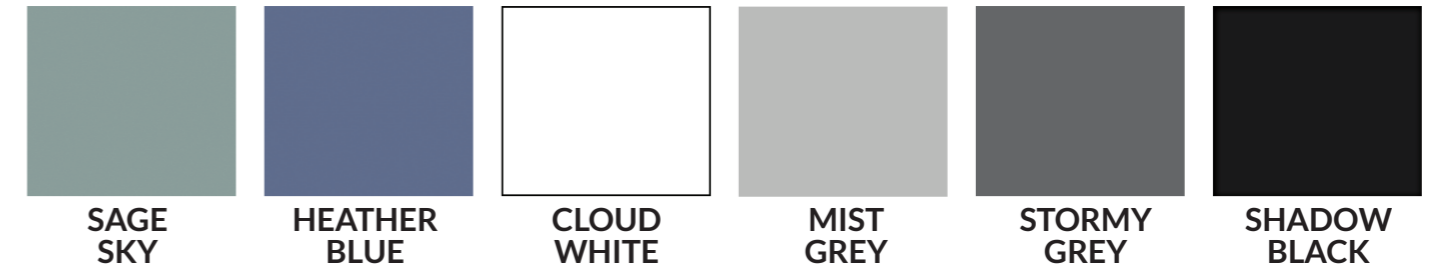

Premium Primed Finish:

The beauty of the grain may be visible on some of the real wood door material.

All our Eco-Urban products from our Thru brand are meticulously prepared, featuring a premium high-quality primer. These specialized paint materials, developed for us in Germany by the world-renowned paint supplier "Remmers," ensure a superior finish. While we acknowledge that some customers may find the finish satisfactory, applying a topcoat is required before installation, followed by touch-ups as needed.

One point to note is that all primed or painted doors but especially black primed doors will show movement between door rails and panels, the panel will possibly show "shrinkage" in the finish at the edges which will ultimately lead to customers unease, this is not a manufacturing issue, these doors need to be finished on site.

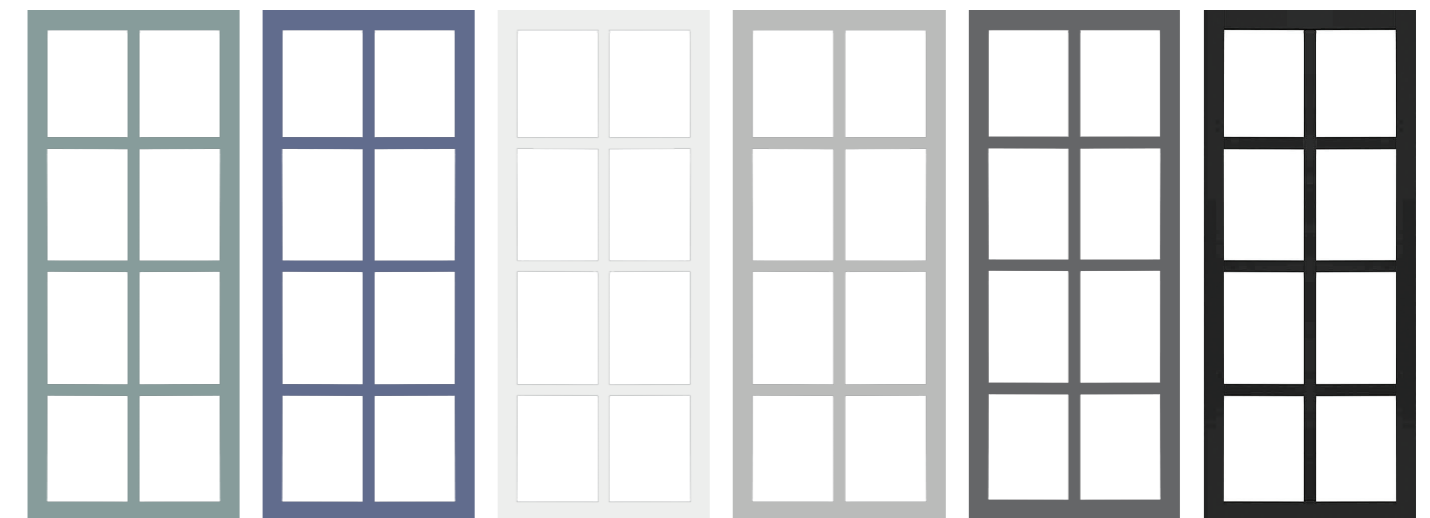

THRU-SLIDE Eco-Urban Doors: Tracks

Tracks Available

With our selection of sliding door tracks, you can choose the style that best suits your needs and design idea. Explore our collection today and elevate the look and functionality of your space with our top-quality sliding door tracks.



For those who favour a rustic and industrial vibe, we offer the barn style black track. The black matte finish is sleek and stylish, adding character and charm to any space. Its sturdy construction also ensures a secure and smooth sliding operation for your door.

The top mounted stainless steel barn track that is perfect for larger and heavier doors. The track's unique design adds a modern and industrial touch, creating a visually striking statement in your space. Its robust construction guarantees the safety and security of your door.



The tubular sleek stainless steel track, which is perfect for those who prefer a modern and elegant aesthetic. The stainless steel finish not only adds a touch of sophistication to your space but also ensures the durability and longevity of the track.



Elevate your home's style with our premium sliding door tracks. Designed for both aesthetics and functionality, our high-quality sliding door systems add elegance and sophistication to any space. Browse our selection to upgrade your home today.



THRU-SLIDE Eco-Urban Doors: Tracks

Flat Bar Tracks

Our Top Mounted and Barn Style Track bars, available in both black and stainless steel finishes, will be supplied in two sections that require assembly. Please use only the screws, plugs, and washers provided to fix them securely.

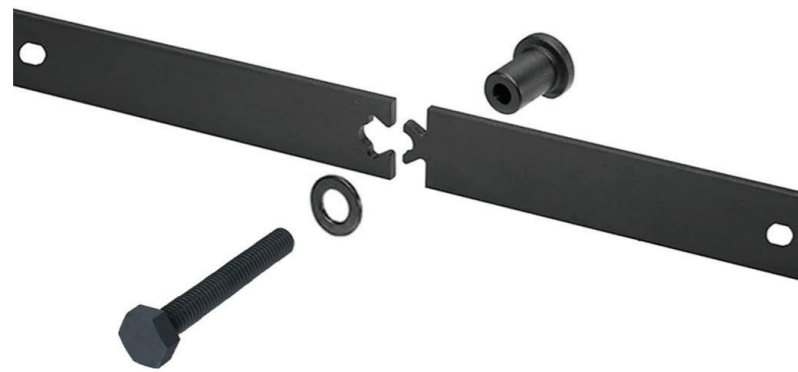

THRU-SLIDE Eco-Urban Doors: Tracks

Double Doors Track Joint Bracket

Each double door system is supplied with a joint bracket that connects the two brackets into one. Our high-quality joint bracket boasts a smooth finish that ensures a seamless connection between the tracks, further enhancing the overall look and feel of the sliding door system. You can rely on us to provide you with the best quality joint bracket for all your sliding door needs.

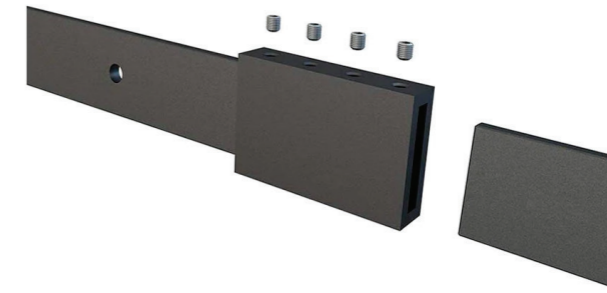

THRU-SLIDE Eco-Urban Doors: Sizing

Available Bespoke and in standard imperial and metric UK door sizes.

Single Sliding Doors:

1981x686mm Door - For Openings 1970mm High x 666mm Wide
1981x762mm Door - For Openings 1970mm High x 742mm Wide
1981x838mm Door - For Openings 1970mm High x 818mm Wide
2040x726mm Door - For Openings 2030mm High x 706mm Wide
2040x826mm Door - For Openings 2030mm High x 806mm Wide

Bespoke:

Min-max opening Width & Height: 580-940mm
Min-max opening height: 1790-2340mm

*Smaller and larger sizes may be available, please ask for a quote if you need something different for under your staircase etc., we can also supply the full range pre-hinged and as a full frame/door set.

THRU-SLIDE Eco-Urban Doors: Panel & Glass Options

Available Bespoke and in standard imperial and metric UK door sizes.

Double Doors:

1981x686mm Doors - For Openings 1970mm High x 1352mm Wide
1981x762mm Doors - For Openings 1970mm High x 1504mm Wide
1981x838mm Doors - For Openings 1970mm High x 1656mm Wide
2040x726mm Doors - For Openings 2030mm High x 1432mm Wide
2040x826mm Doors - For Openings 2030mm High x 1632mm Wide

Bespoke:

Min-max opening Width & Height: 1180-1880mm
Min-max opening height: 1790-2340mm

*Smaller and larger sizes may be available, please ask for a quote if you need something different for under your staircase etc., we can also supply the full range pre-hinged and as a full frame/door set.



THRU-SLIDE Eco-Urban Doors: Panel & Glass Options

Panel, Clear Glass & Frosted Glass options are available.

Glass: All doors except Baltimore will be 4mm Toughened glass, some of the smallest panes may be 4mm annealed glass, Baltimore doors are glazed with 6mm thick glass.

Panels: 9mm thick moisture-resistant MDF, recessed within the door thickness.



For our glazed versions we also have a choice of:

- White Laminate Glass
- Smoke Tinted Glass
- Reeded Glass

If there is any glass other than those listed above that you would like to order, please contact your supplier for a quote.

THRU-SLIDE Eco-Urban Doors: Panel & Glass Options

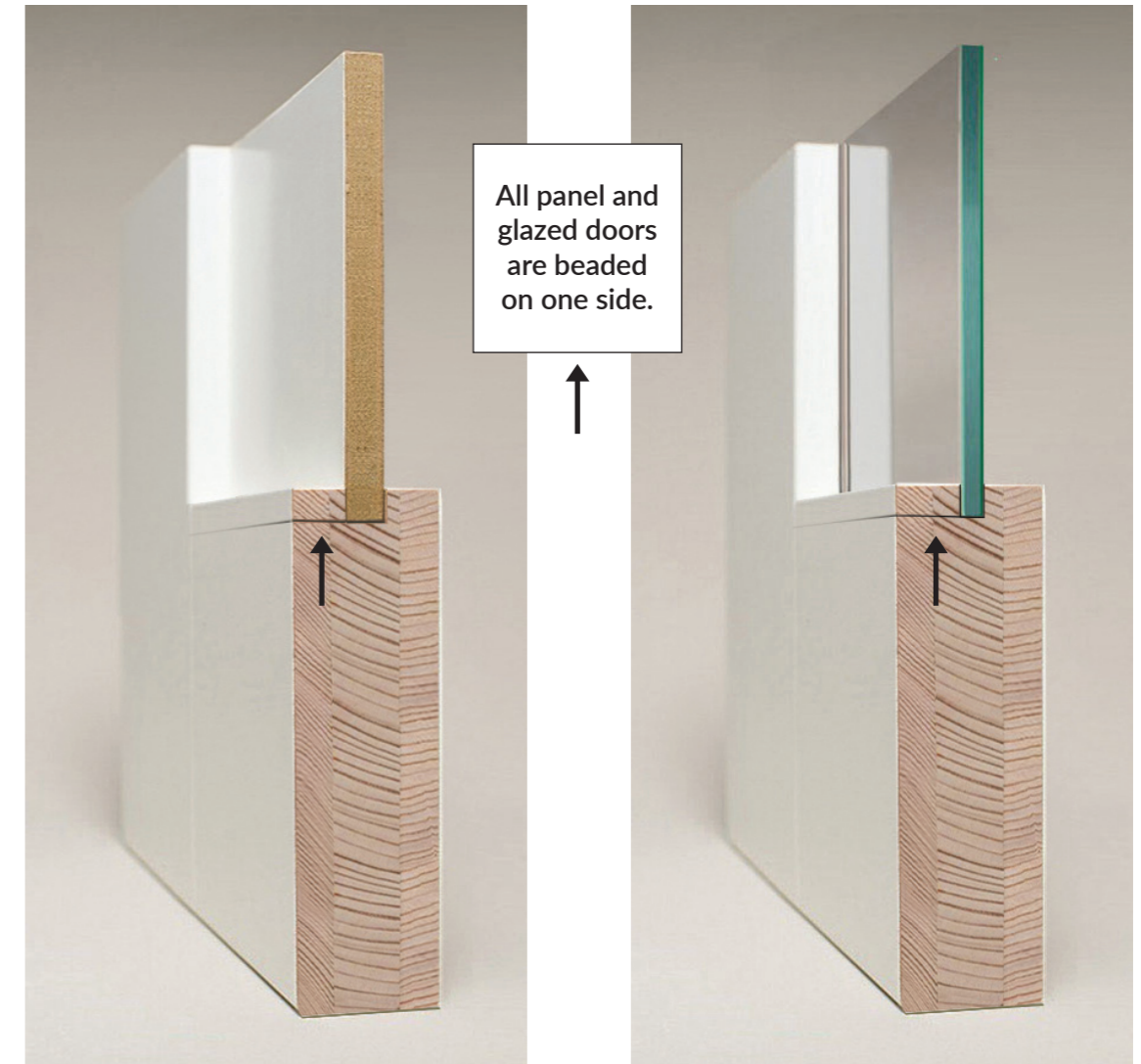

Panel Doors:

Rails & Stiles: Solid laminated timber.

Panels: 9mm thick moisture resistant MDF, recessed within the door thickness.

Finish: Premium Primed

Glazed Doors:

Rails & Stiles: Solid laminated timber.

Glass: All doors except Baltimore will be 4mm Toughened glass, some of the smallest panes may be 4mm annealed glass, Baltimore doors are glazed with 6mm thick glass.

Finish: Premium Primed



THRU-SLIDE Eco-Urban Doors: Glazing

Glass supplied with our Handmade Eco-Urban doors conforms to British Standard BS EN 12600

Glazing:

A feature of safety glass is that each pane will have a safety stamp etched within the glass. The style and positioning of this etching varies depending on the manufacturer, most will be visible but some may be discreet or on occasion, they are hidden. This feature is in order to comply with safety building regulations and we, therefore, have no control over the requirement or style (annealed glass will not have a safety stamp).

Safety glass is defined as glass which must have passed an impact test and either must not break or must break safely. The test is intended to classify flat glass products into three principal classes by performance under impact and by mode of breakage.

Characteristics of toughened glass:

Fragmentation

Should the glass break, it will fragment into small pieces with dulled edges, thereby greatly reducing the risk of injury.

Increased resistance to mechanical stresses

Toughened glass offers impact resistance and bending strength up to five times more than annealed glass of the same thickness.

Increased resistance to thermal stresses

It offers greater resistance to thermal stresses than ordinary float annealed glass.





THRU-SLIDE Eco-Urban Doors: Designs - Single Doors

**DD6301
BALTIMORE
PANEL**



**DD6301
BALTIMORE
GLAZED**

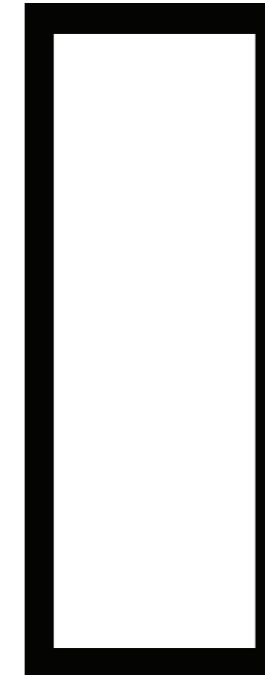

**DD6305
MANCHESTER
PANEL**



**DD6306
MANCHESTER
GLAZED**

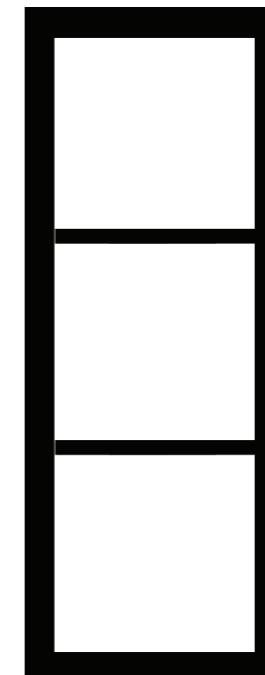

**DD6310
STATEN
GLAZED & PANEL**

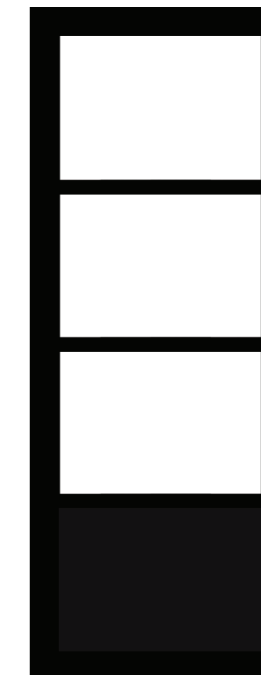

SINGLE DOORS

THRU-SLIDE Eco-Urban Doors: Designs - Single Doors

DD6307
BROOKLYN
PANEL



DD6308
BROOKLYN
GLAZED

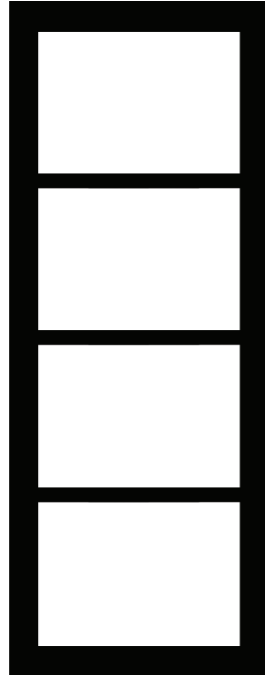

DD6309
BERKLEY
GLAZED & PANEL



THRU-SLIDE Eco-Urban Doors: Designs - Single Doors

DD6312
SHEFFIELD
PANEL



DD6312
SHEFFIELD
GLAZED WITH
SMALL PANEL

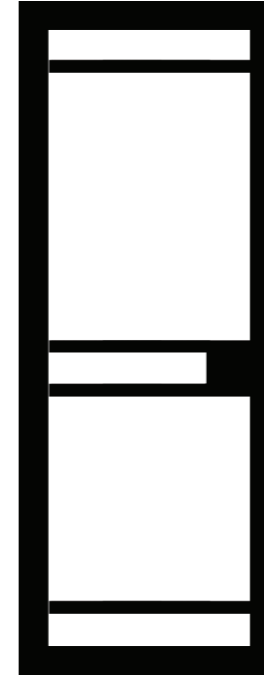

DD6314
GLASGOW
PANEL



DD6314
GLASGOW
GLAZED

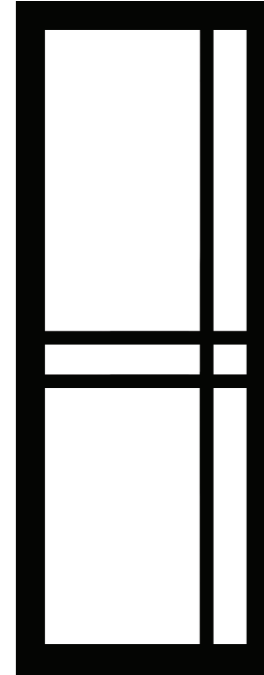

DD6311
BOSTON
PANEL



DD6311
BOSTON
GLAZED

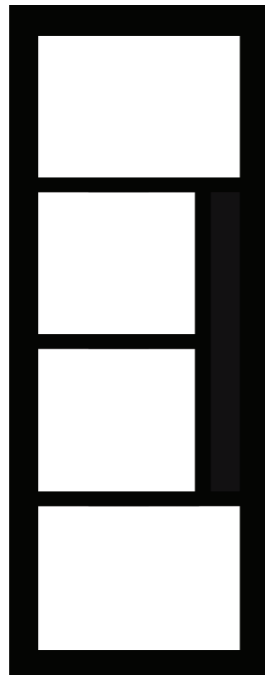

DD6315
BRONX
PANEL



DD6315
BRONX
GLAZED

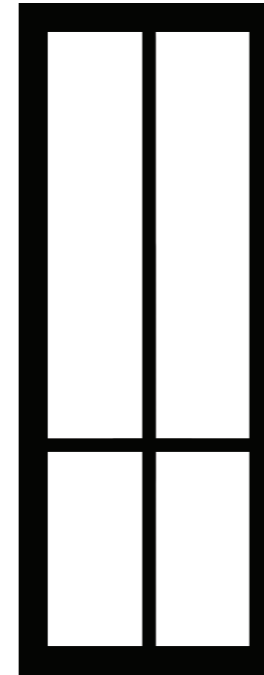

DD6316
LEITH
PANEL



DD6316
LEITH
GLAZED WITH
SMALL PANEL

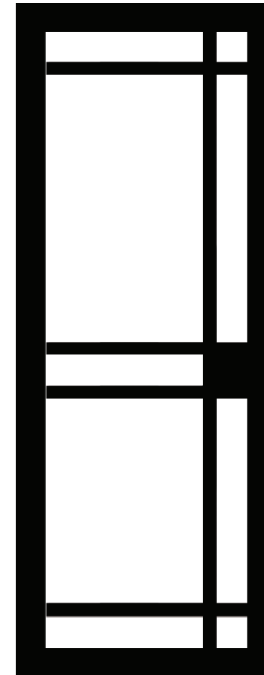

THRU-SLIDE Eco-Urban Doors: Designs - Single Doors

DD6318
PERTH
PANEL



DD6318
PERTH
GLAZED

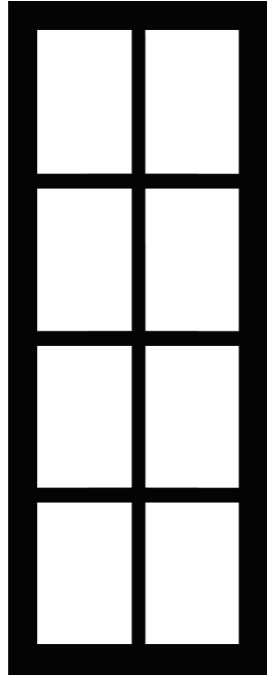

DD6400
OSLO
PANEL



DD6401
MALMO
PANEL



DD6407
STOCKHOLM
PANEL



THRU-SLIDE Eco-Urban Doors: Designs - Single Doors

DD6402
TROMSO
PANEL

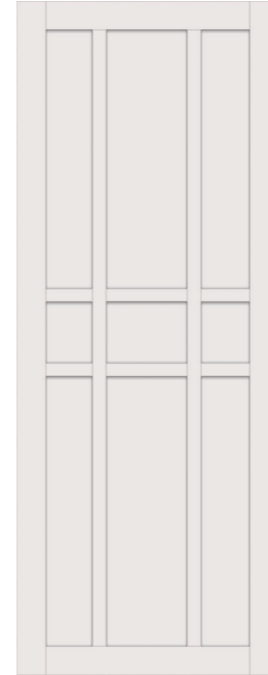

DD6402
TROMSO
GLAZED WITH
SMALL PANEL

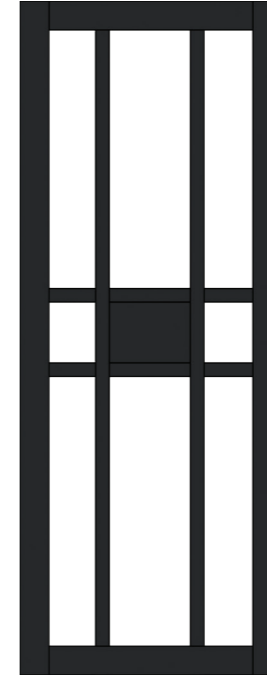

DD6403
ORKNEY
PANEL



DD6403
ORKNEY
PANEL & GLAZED

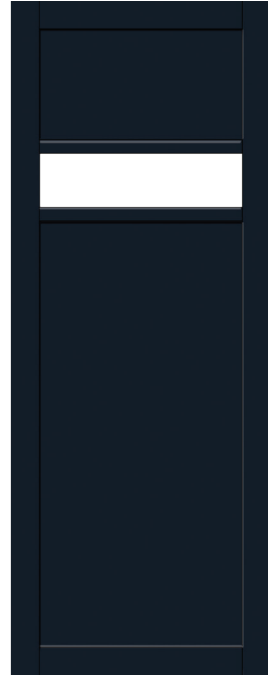

DD6411
SUBURBAN
PANEL



DD6411
SUBURBAN
GLAZED

FROSTED
GLASS

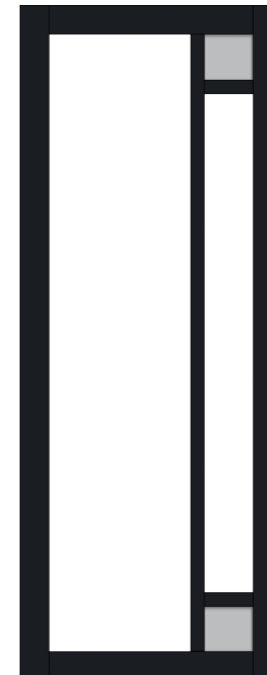

DD6405
METROPOLITAN
PANEL



DD6405
METROPOLITAN
GLAZED



THRU-SLIDE Eco-Urban Doors: Designs - Single Doors

DD6404
CORNWALL
PANEL

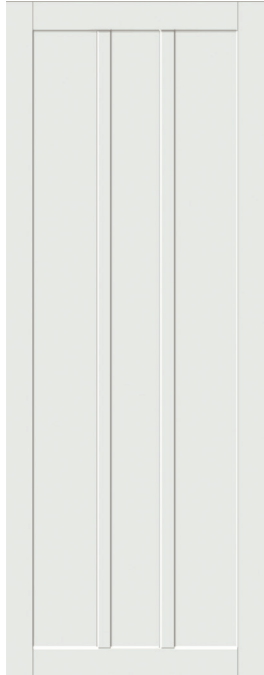

DD6404
CORNWALL
PANEL & GLAZED



DD6410
AVENUE
GLAZED & PANEL



THRU-SLIDE Eco-Urban Doors: Designs - Single Doors

DD6413
HAMPTON
PANEL

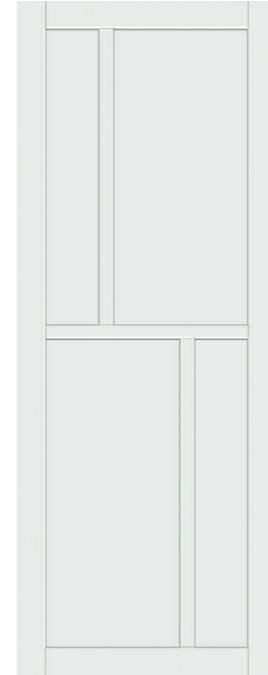

DD6413
HAMPTON
GLAZED



DD6414
MALVAN
PANEL



DD6414
MALVAN
GLAZED

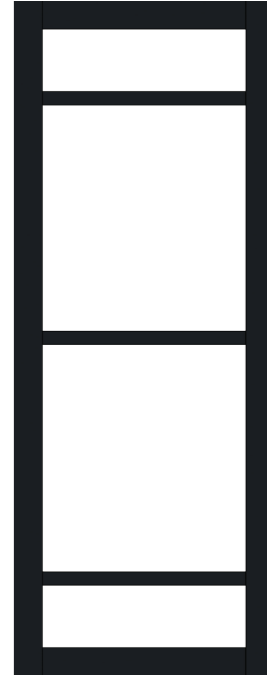

DD6434
IRVINE
PANEL

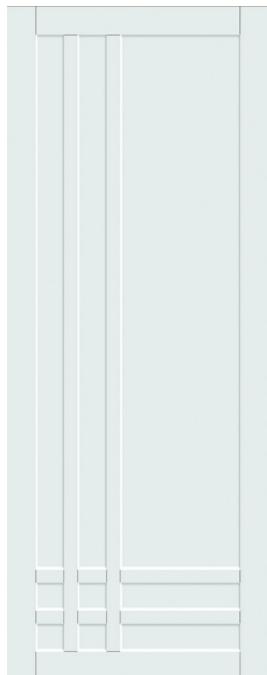

DD6417
SYDNEY
PANEL

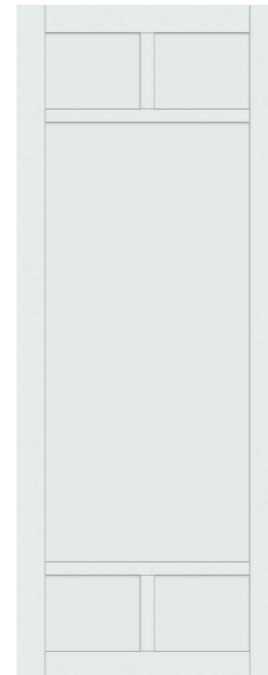

DD6417
SYDNEY
GLAZED



DD6419
CAIRO
PANEL

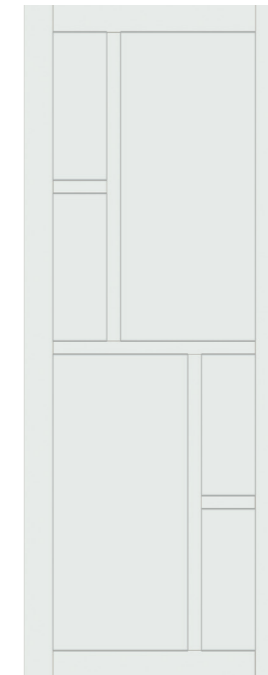

DD6419
CAIRO
GLAZED

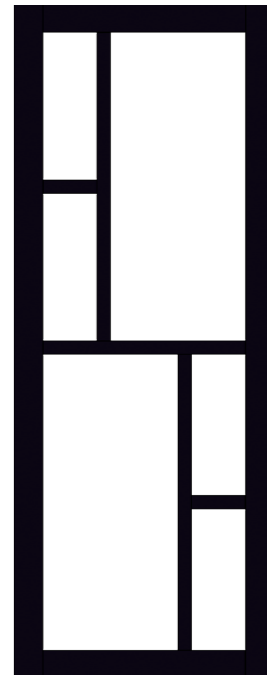

THRU-SLIDE Eco-Urban Doors: Designs - Single Doors

DD6415
KOCHI
PANEL

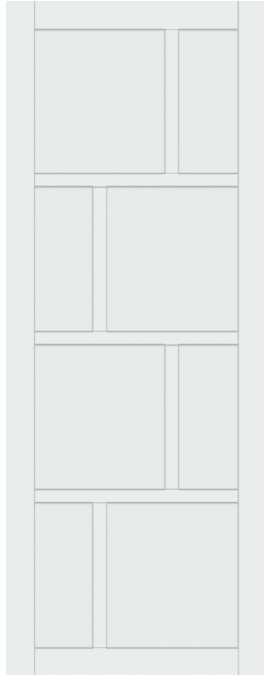

DD6415
KOCHI
GLAZED



DD6416
CUSCO
PANEL & GLAZED



THRU-SLIDE Eco-Urban Doors: Designs - Single Doors

DD6424
QUEENSLAND
PANEL



DD6424
QUEENSLAND
PANEL & GLAZED

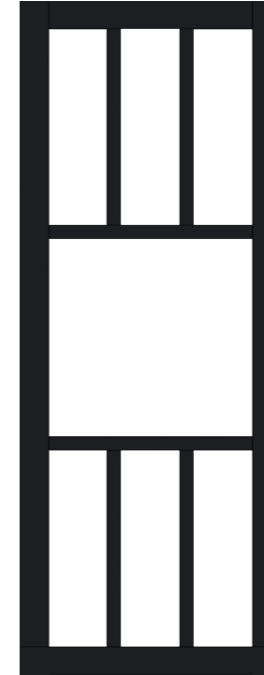

DD6425
TASMANIA
GLAZED

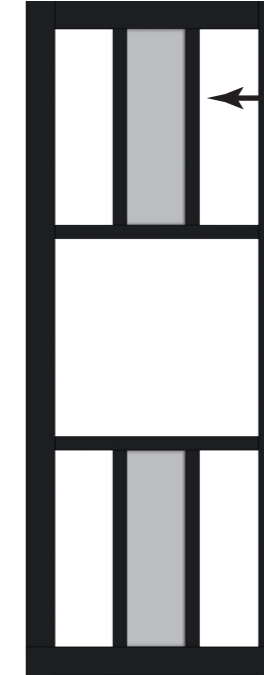

FROSTED
GLASS

DD6422
MILAN
PANEL

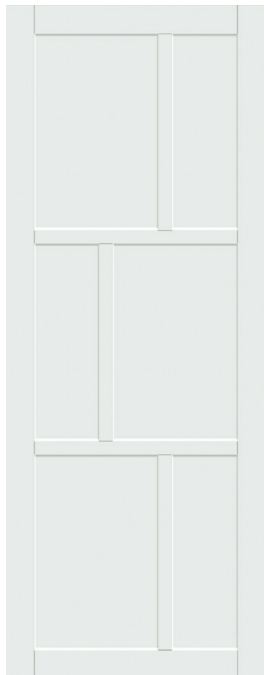

DD6422
MILAN
GLAZED

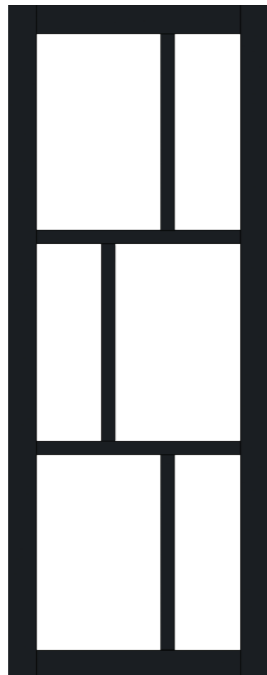

DD6423
TOKYO
PANEL & GLAZED

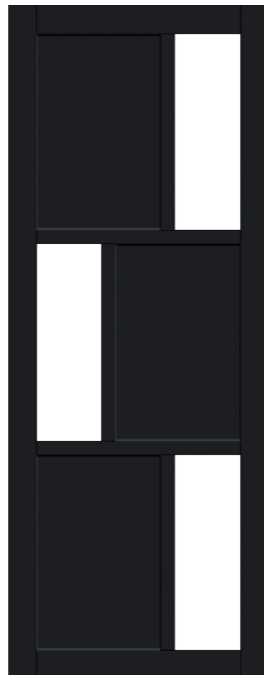

DD6429
ISLA
PANEL



DD6429
ISLA
GLAZED



DD6431
JURA
GLAZED WITH
SMALL PANEL



THRU-SLIDE Eco-Urban Doors: Designs - Single Doors

DD6432
ARRAN
PANEL



DD6432
ARRAN
GLAZED

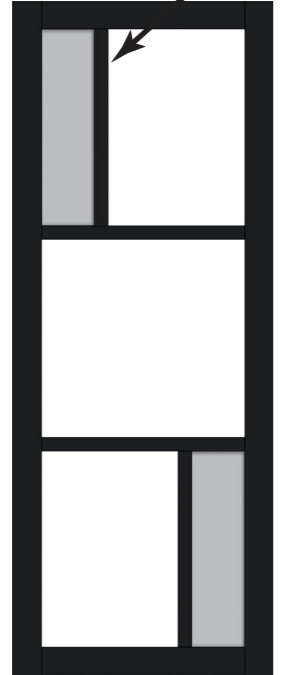

DD6427
LAGOS
PANEL



DD6427
LAGOS
PANEL & GLAZED

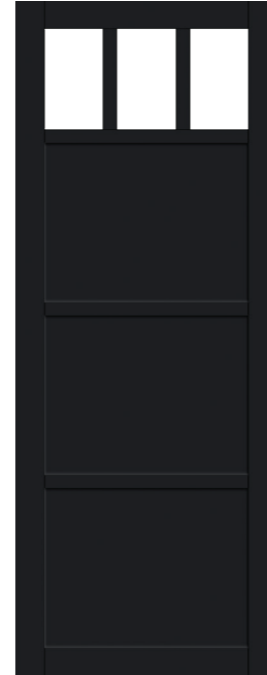

THRU-SLIDE Eco-Urban Doors: Designs - Single Doors

DD6436
MORNINGSIDE
PANEL

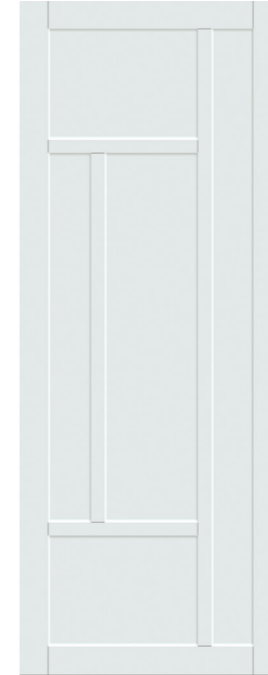

DD6436
MORNINGSIDE
GLAZED



DD6438
PORTOBELLO
GLAZED

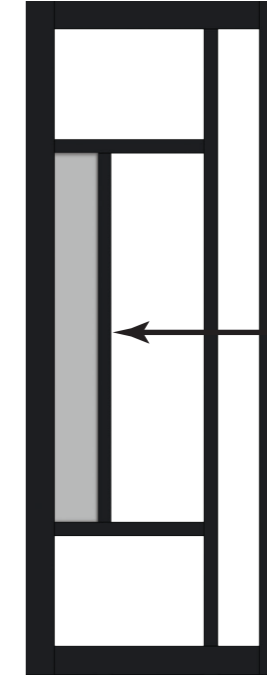

DD6428
SINTRA
PANEL

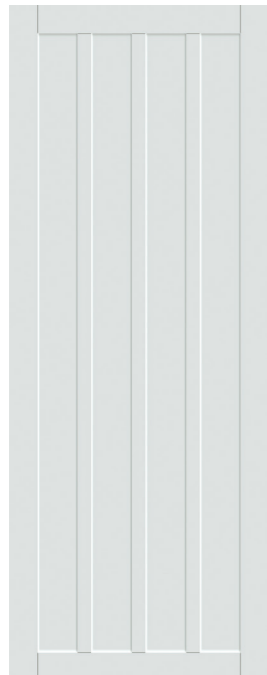

DD6428
SINTRA
GLAZED



DD6433
CALEDONIA
PANEL



DD6436
COLORADO
PANEL



DD6435
SKYE
PANEL



THRU-SLIDE Eco-Urban Doors: Designs - Double Doors



DOUBLE DOORS

DD6301
BALTIMORE
PANEL



DD6301
BALTIMORE
GLAZED

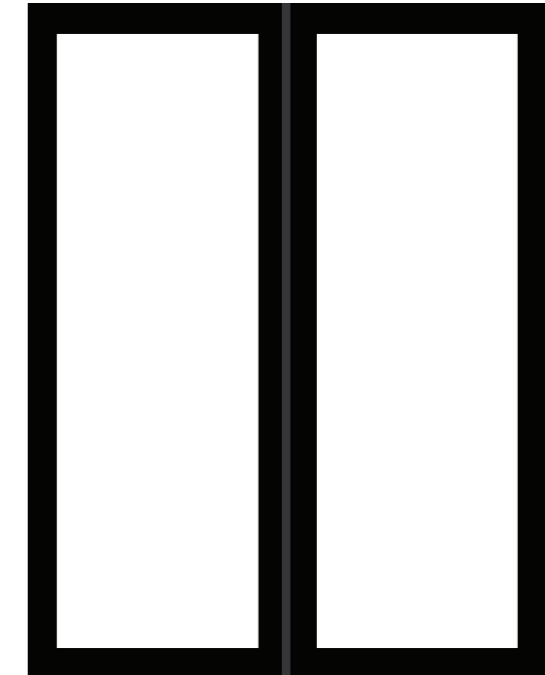

DD6305
MANCHESTER
PANEL



DD6306
MANCHESTER
GLAZED

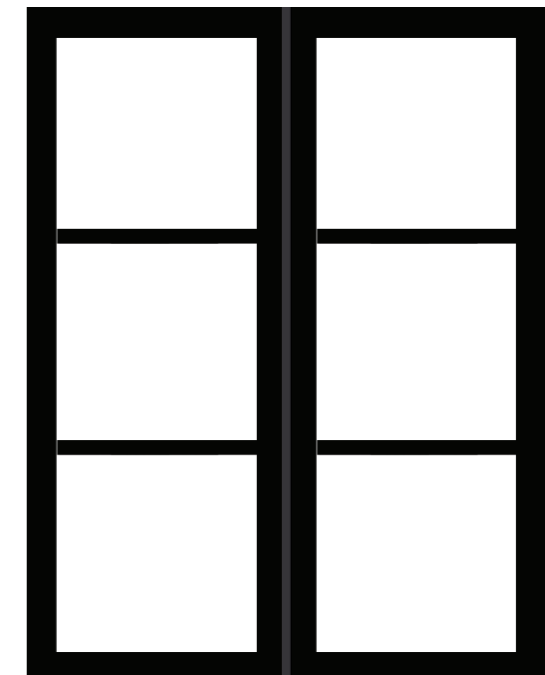

THRU-SLIDE Eco-Urban Doors: Designs - Double Doors

DD6307
BROOKLYN
PANEL



DD6307
BROOKLYN
GLAZED

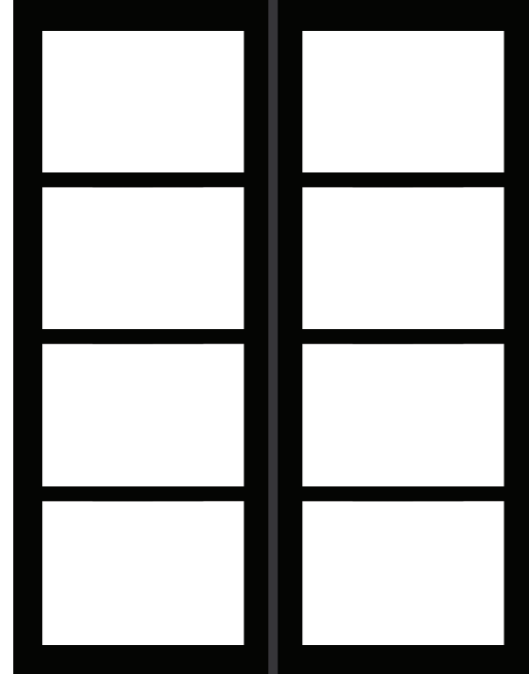

THRU-SLIDE Eco-Urban Doors: Designs - Double Doors

DD6311
BOSTON
PANEL



DD6311
BOSTON
GLAZED

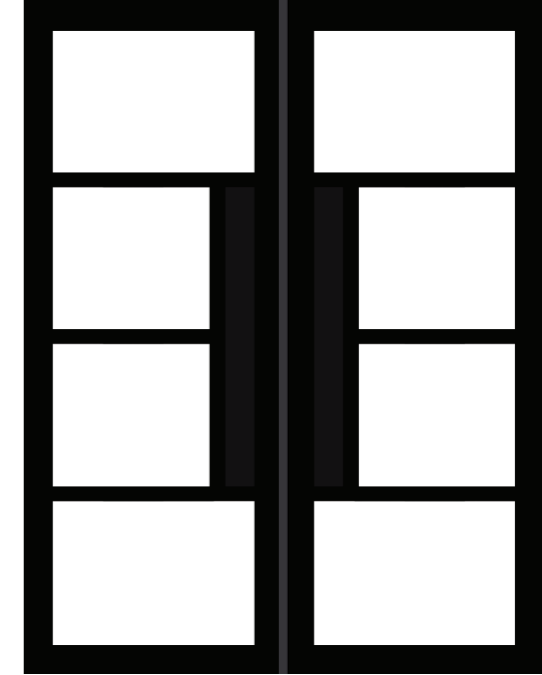

DD6310
STATEN
GLAZED & PANEL

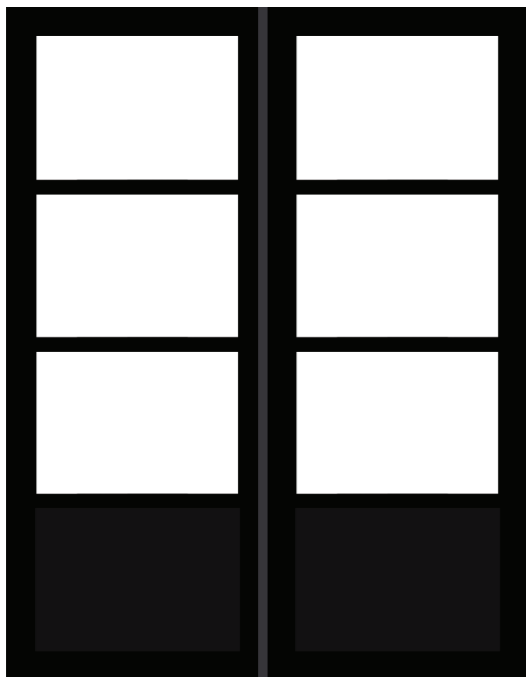

DD6309
BERKLEY
GLAZED & PANEL

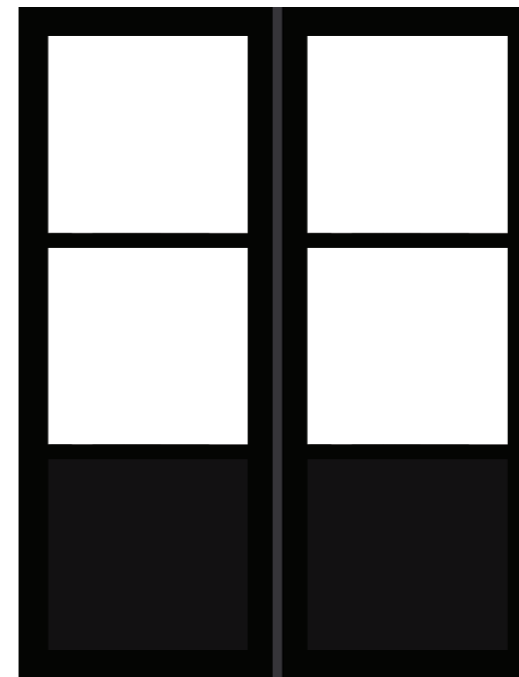

THRU-SLIDE Eco-Urban Doors: Designs - Double Doors

DD6312
SHEFFIELD
PANEL



DD6312
SHEFFIELD
GLAZED & SMALL
PANEL

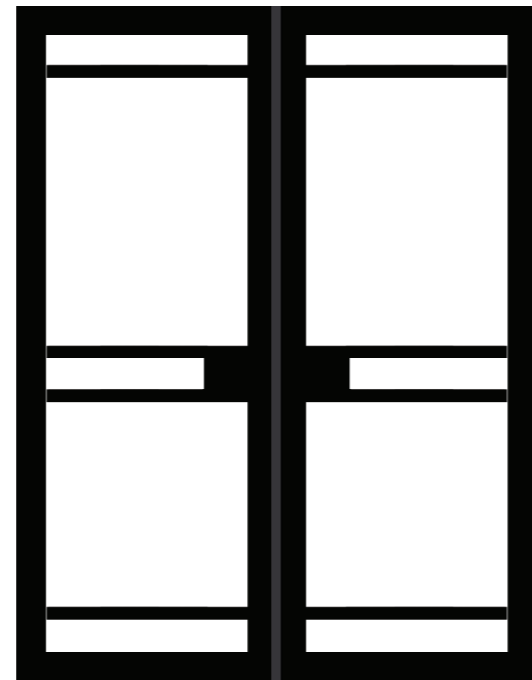

THRU-SLIDE Eco-Urban Doors: Designs - Double Doors

DD6315
BRONX
PANEL



DD6315
BRONX
GLAZED

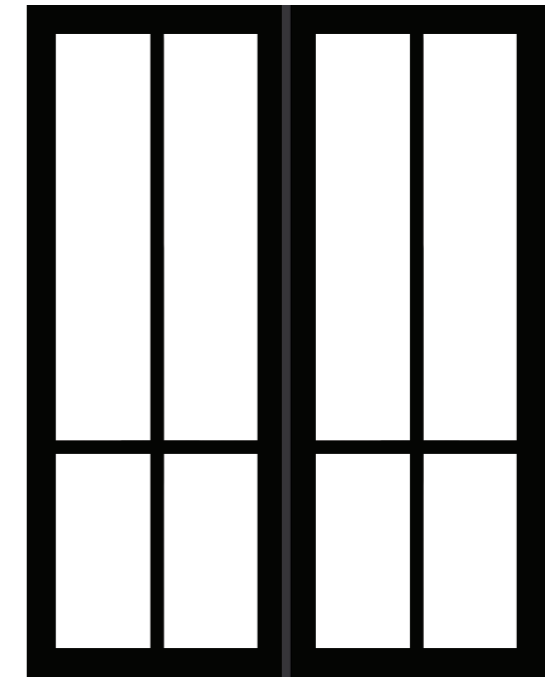

DD6314
GLASGOW
PANEL



DD6314
GLASGOW
GLAZED

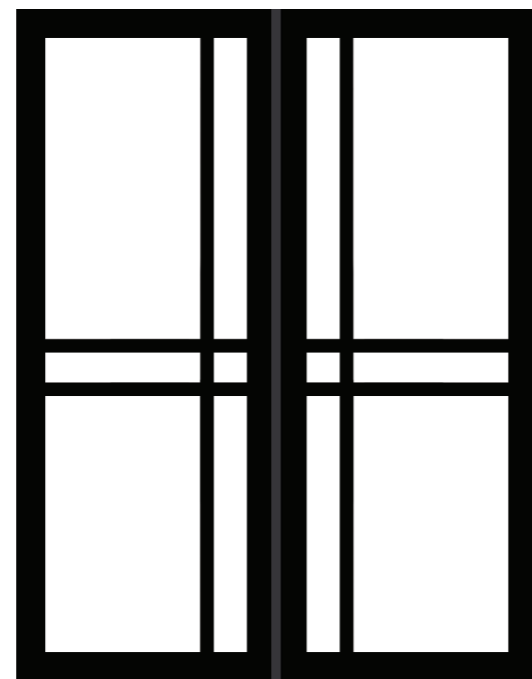

DD6316
LEITH
PANEL



DD6316
LEITH
GLAZED

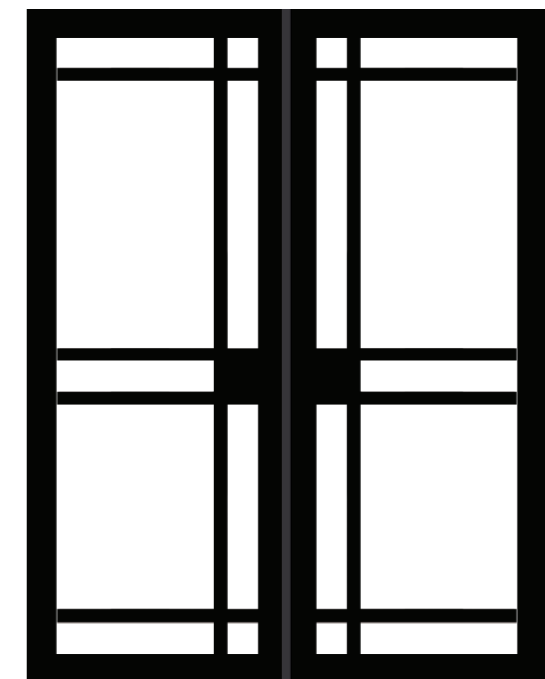

THRU-SLIDE Eco-Urban Doors: Designs - Double Doors

DD6402
TROMOSO
PANEL



DD6402
TROMOSO
GLAZED WITH
SMALL PANEL



DD6403
ORKNEY
PANEL

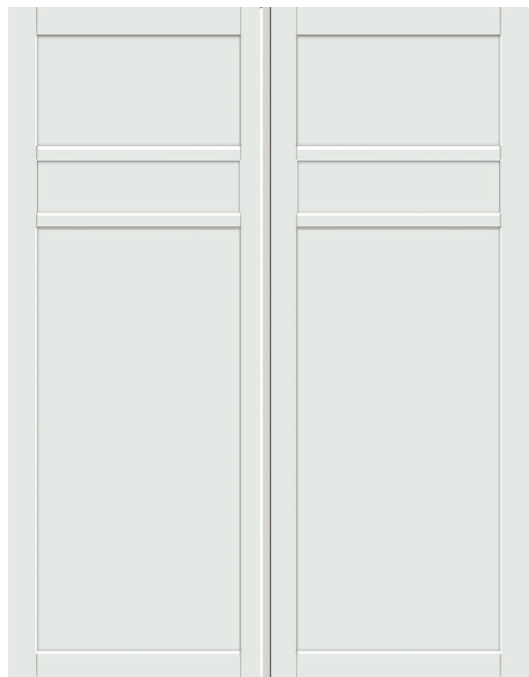

DD6403
ORKNEY
PANEL & GLAZED



THRU-SLIDE Eco-Urban Doors: Designs - Double Doors

DD6318
PERTH
PANEL



DD6318
PERTH
PANEL

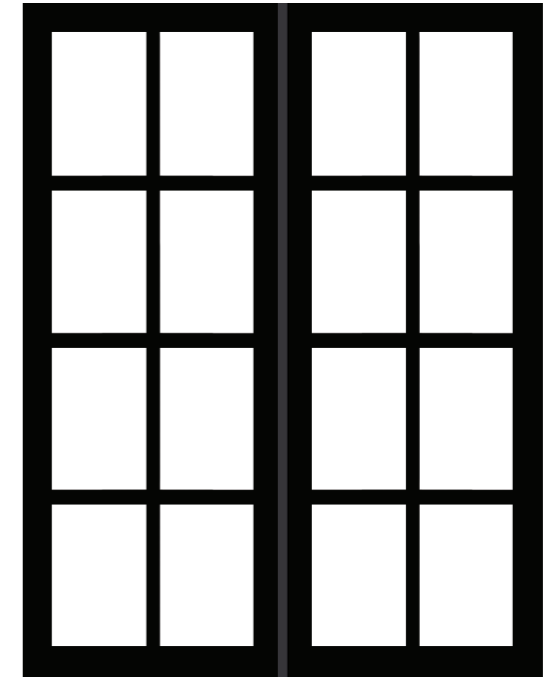

DD6400
OSLO
PANEL



THRU-SLIDE Eco-Urban Doors: Designs - Double Doors

DD6411
SUBURBAN
PANEL

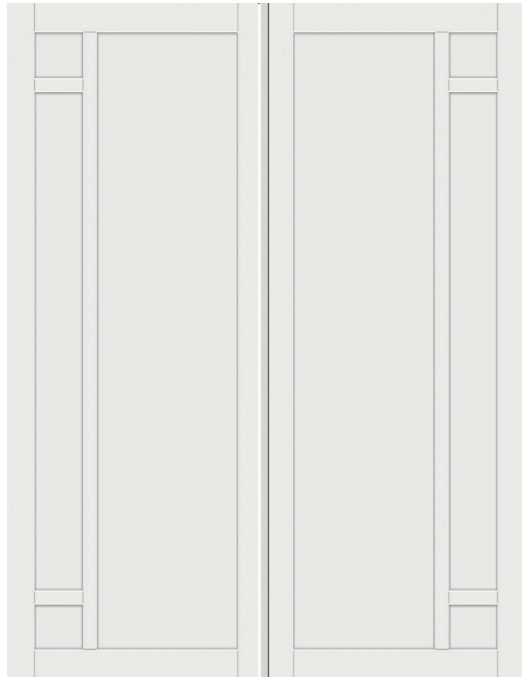

DD6411
SUBURBAN
GLAZED

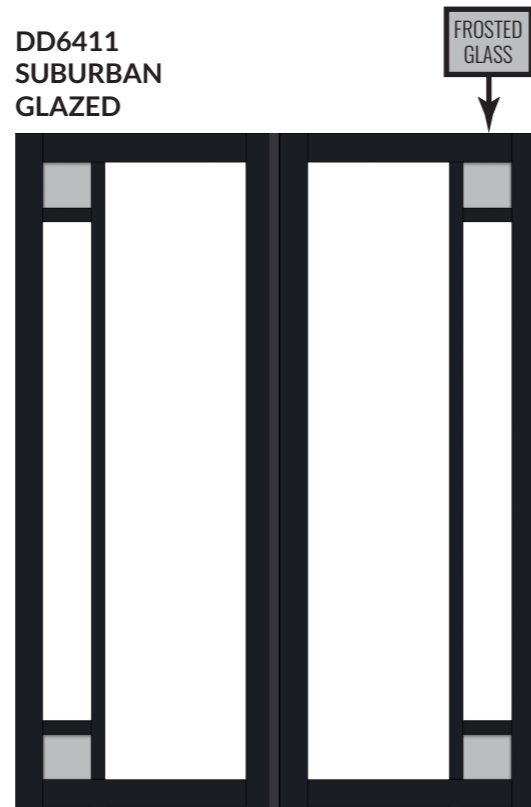

THRU-SLIDE Eco-Urban Doors: Designs - Double Doors

DD6401
MALMO
PANEL

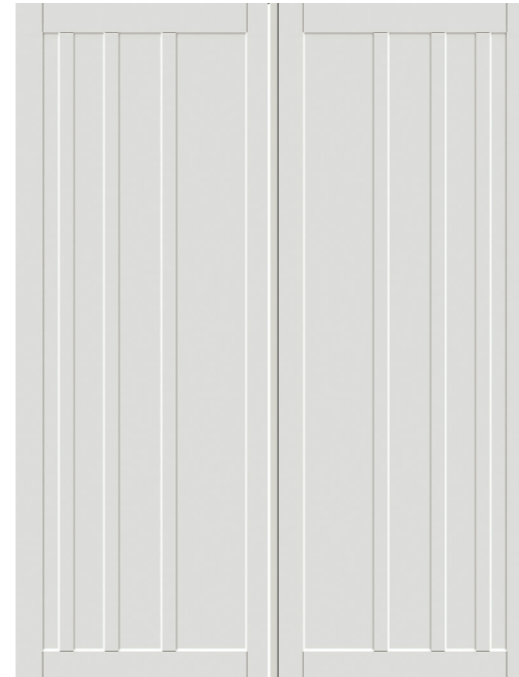

DD6405
METROPOLITAN
PANEL



DD6405
METROPOLITAN
GLAZED

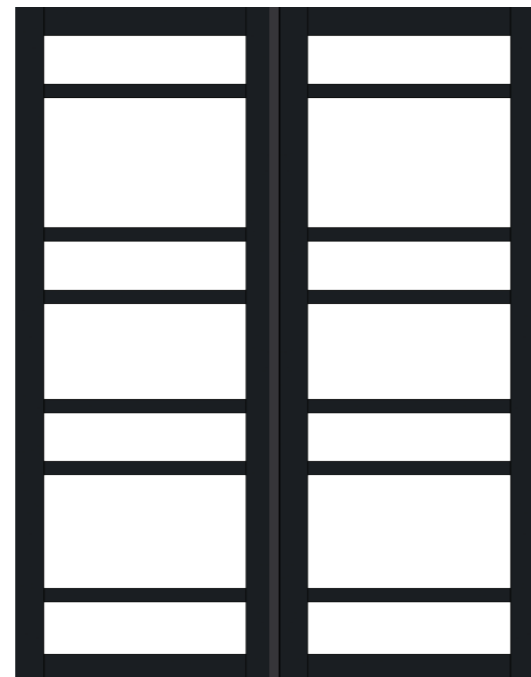

DD6407
STOCKHOLM
PANEL



THRU-SLIDE Eco-Urban Doors: Designs - Double Doors

DD6404
CORNWALL
PANEL



DD6404
CORNWALL
PANEL & GLAZED



THRU-SLIDE Eco-Urban Doors: Designs - Double Doors

DD6409
MELVILLE
PANEL

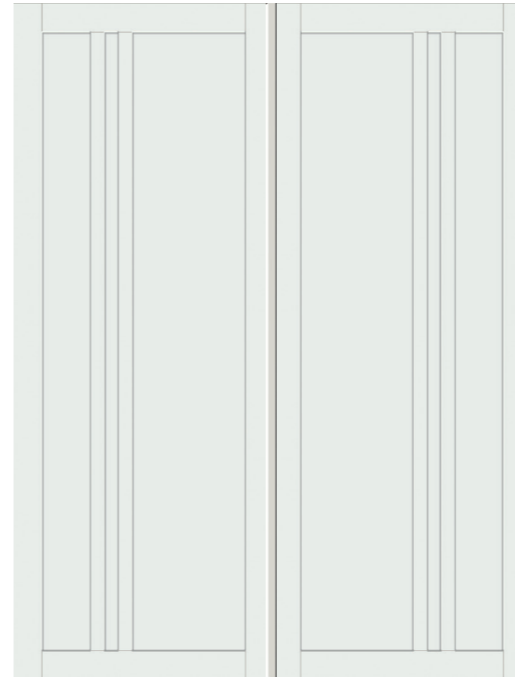

DD6410
AVENUE
GLAZED & PANEL

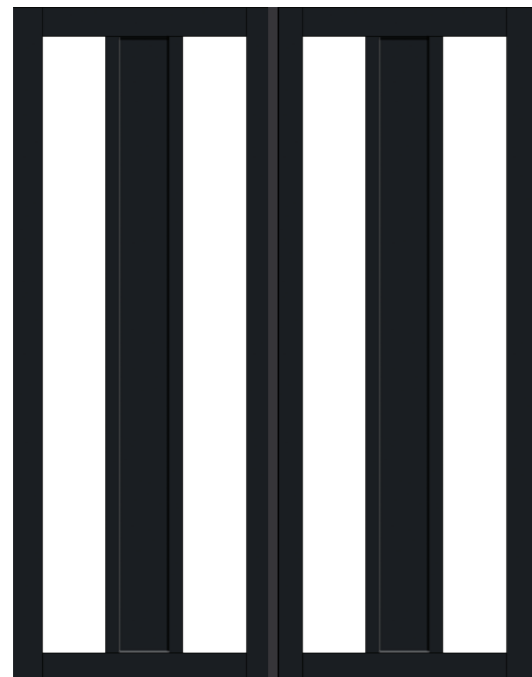

DD6419
CAIRO
PANEL



DD6419
CAIRO
GLAZED

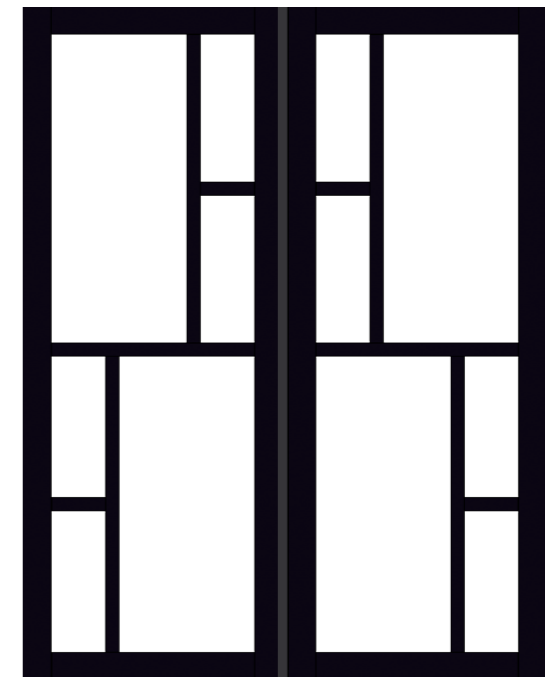

THRU-SLIDE Eco-Urban Doors: Designs - Double Doors

DD6413
HAMPTON
PANEL



DD6413
HAMPTON
GLAZED



DD6414
MALVAN
PANEL

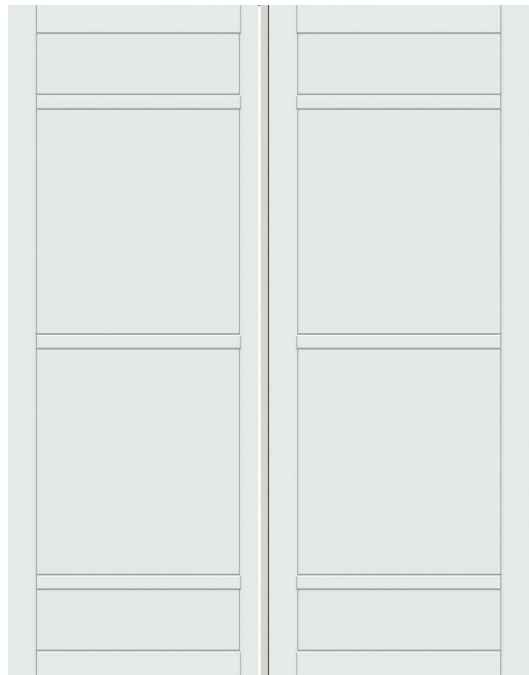

DD6414
MALVAN
GLAZED

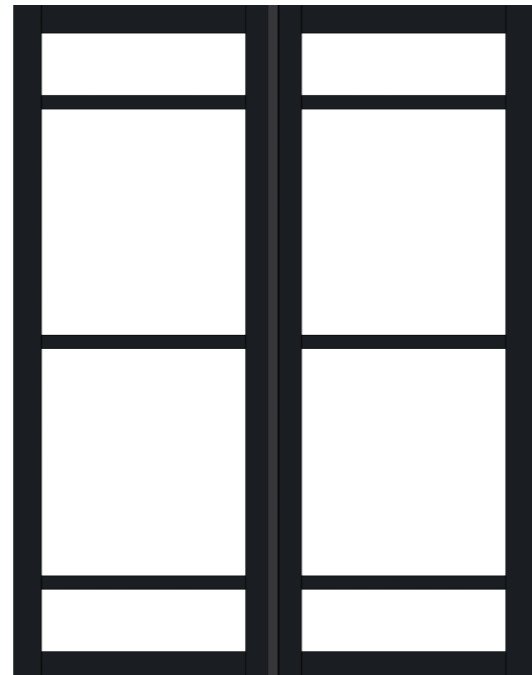

THRU-SLIDE Eco-Urban Doors: Designs - Double Doors

DD6417
SYDNEY
PANEL

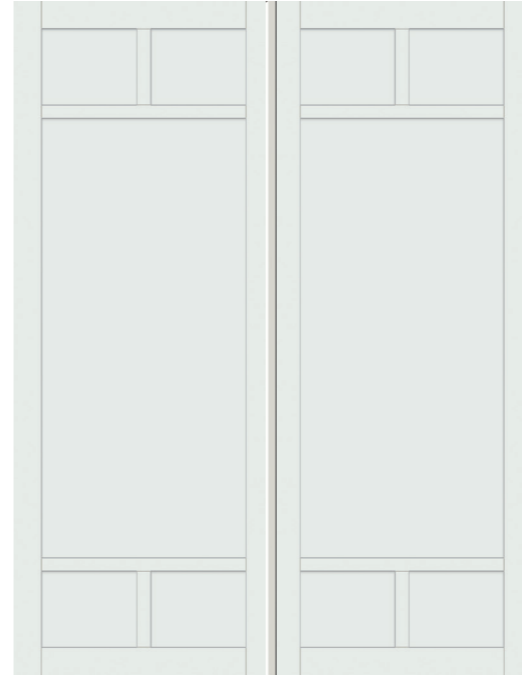

DD6417
SYDNEY
GLAZED

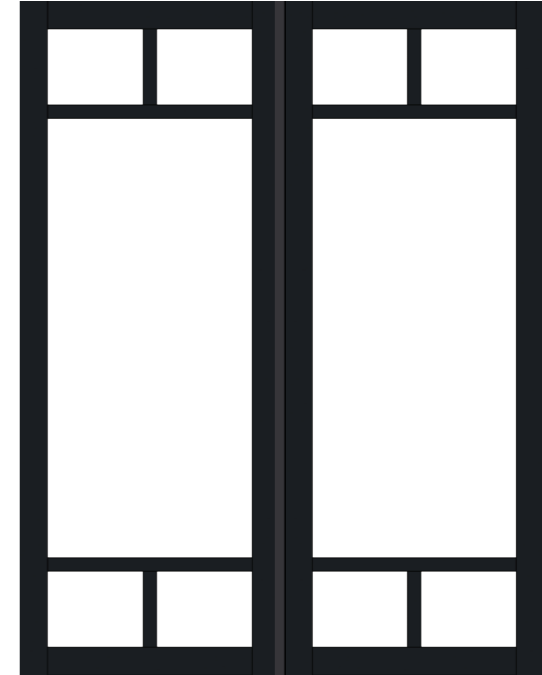

DD6435
SKYE
PANEL

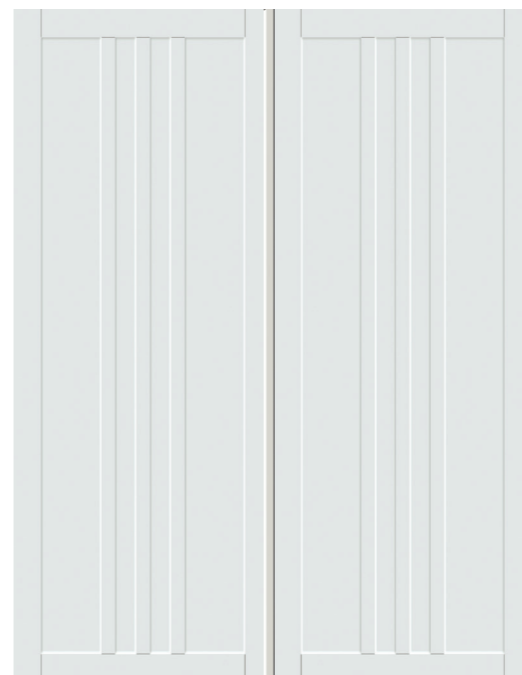

THRU-SLIDE Eco-Urban Doors: Designs - Double Doors

DD6415
KOCHI
PANEL

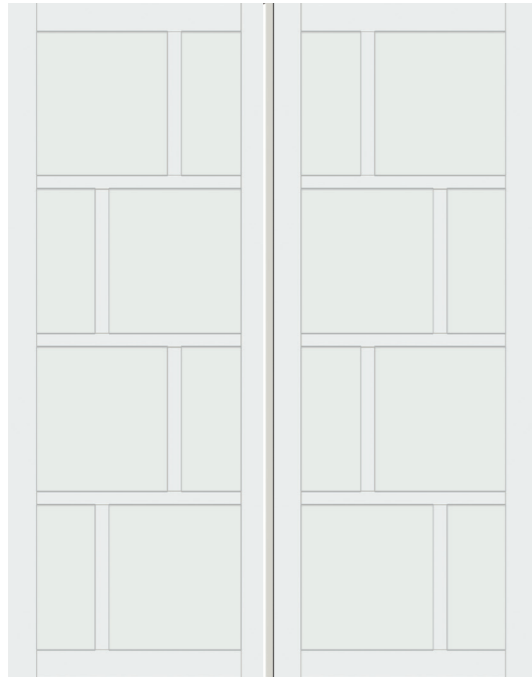

DD6415
KOCHI
GLAZED

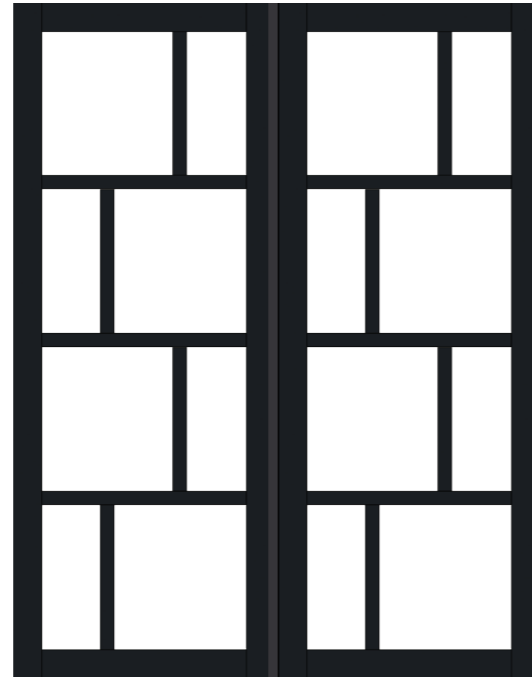

THRU-SLIDE Eco-Urban Doors: Designs - Double Doors

DD6422
MILAN
PANEL

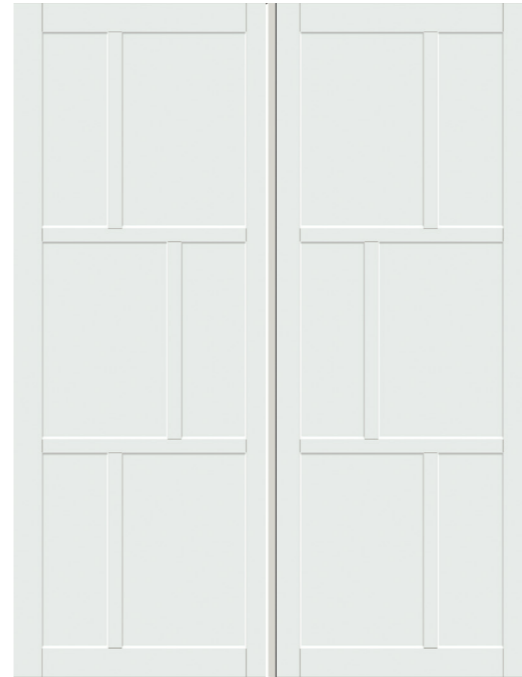

DD6422
MILAN
GLAZED

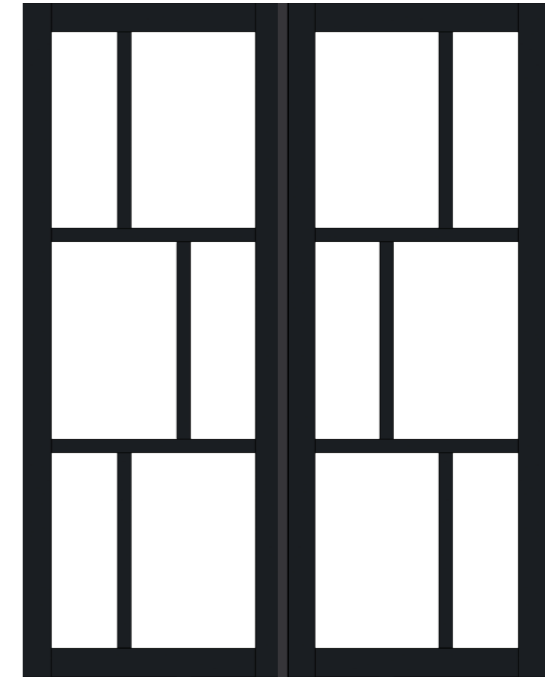

DD6416
CUSCO
PANEL & GLAZED

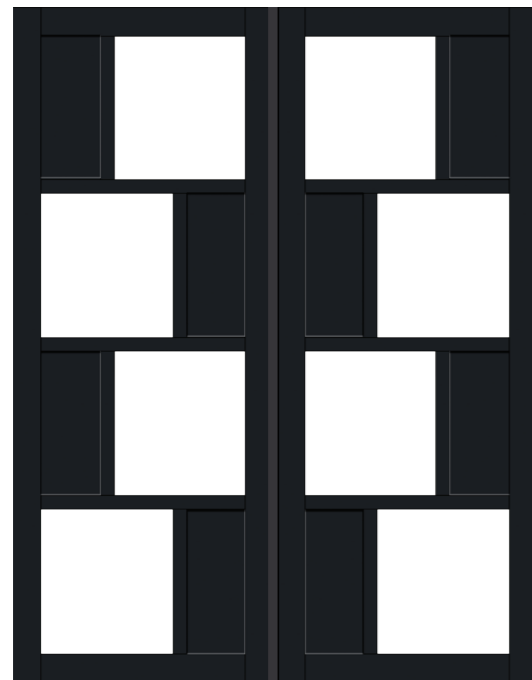

DD6416
TOKYO
PANEL & GLAZED

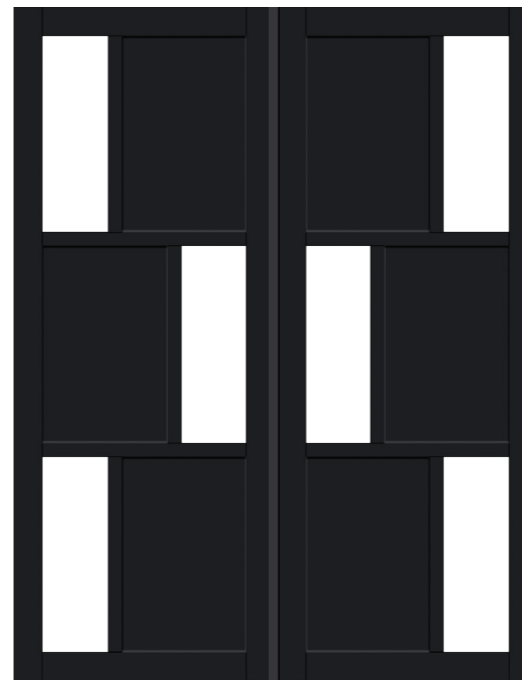

THRU-SLIDE Eco-Urban Doors: Designs - Double Doors

DD6424
KOCHI
PANEL



DD6424
KOCHI
GLAZED

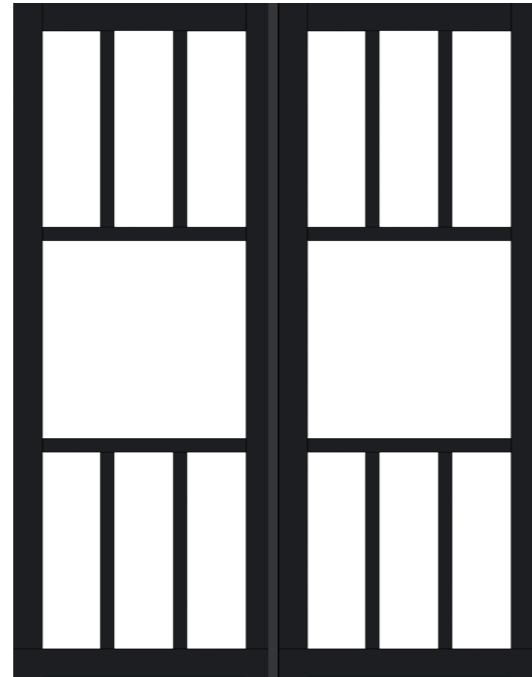

THRU-SLIDE Eco-Urban Doors: Designs - Double Doors

DD6429
ISLA
PANEL



DD6429
ISLA
GLAZED

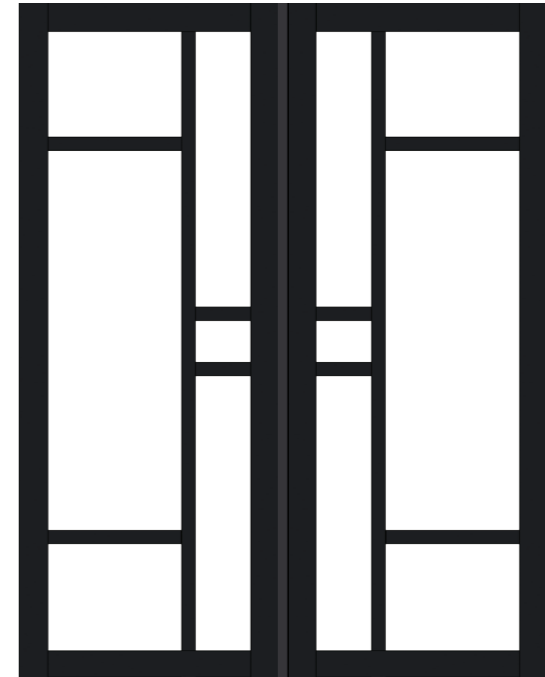

DD6425
TASMANIA
GLAZED

FROSTED
GLASS
↓

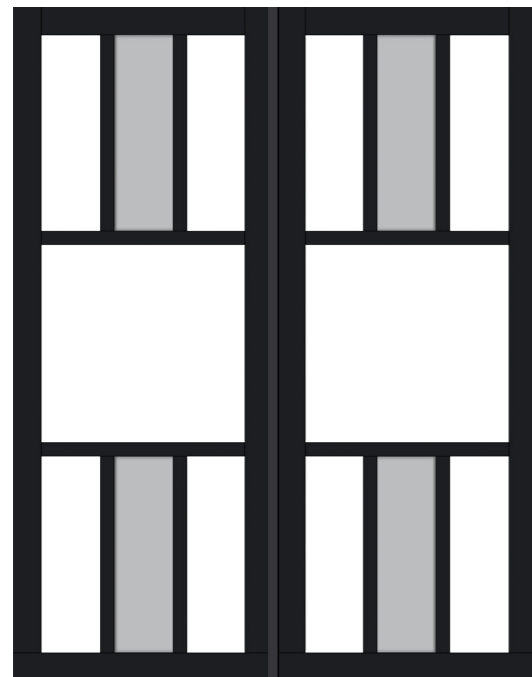

DD6431
JURA
GLAZED WITH
SMALL PANEL

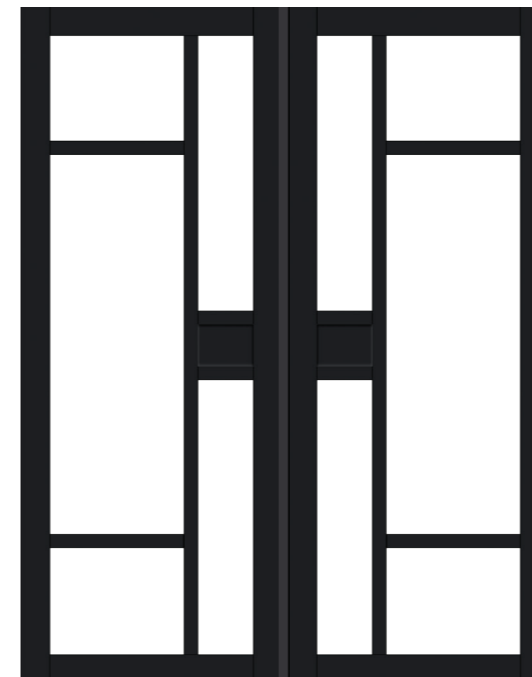

THRU-SLIDE Eco-Urban Doors: Designs - Double Doors

DD6432
ARRAN
PANEL

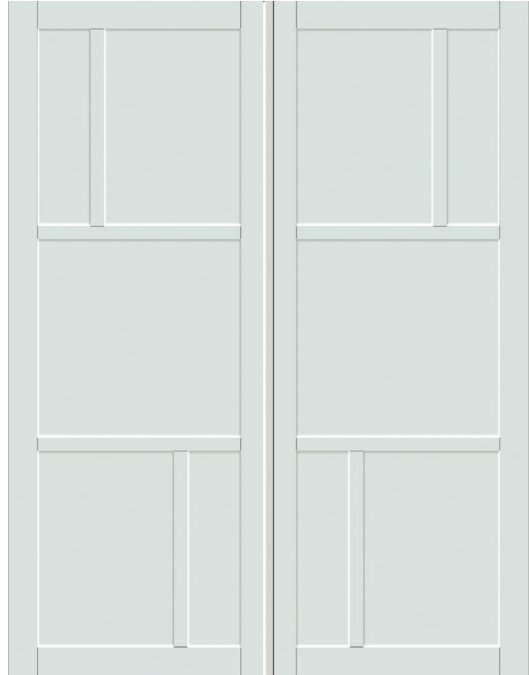

DD6432
ARRAN
GLAZED

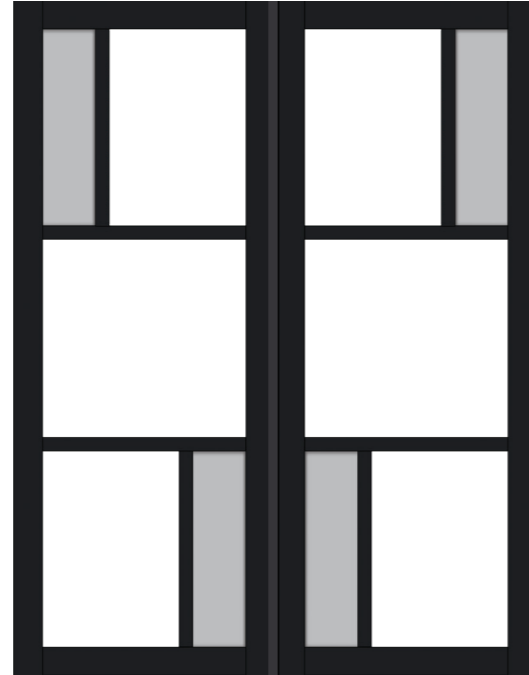

THRU-SLIDE Eco-Urban Doors: Designs - Double Doors

DD6428
SINTRA
PANEL

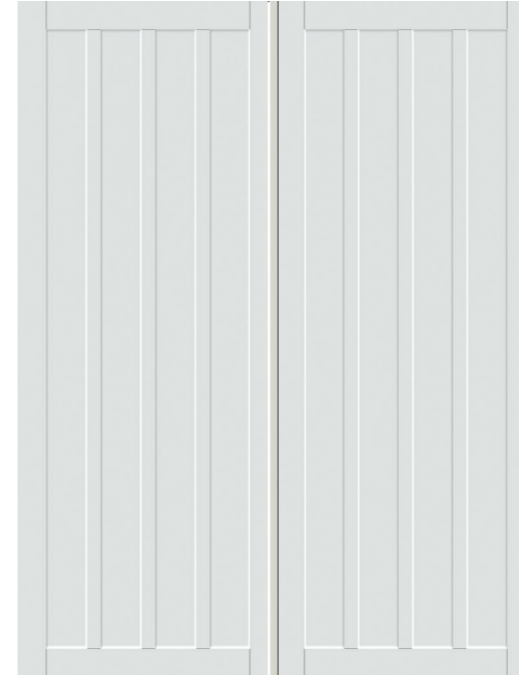

DD6428
SINTRA
GLAZED

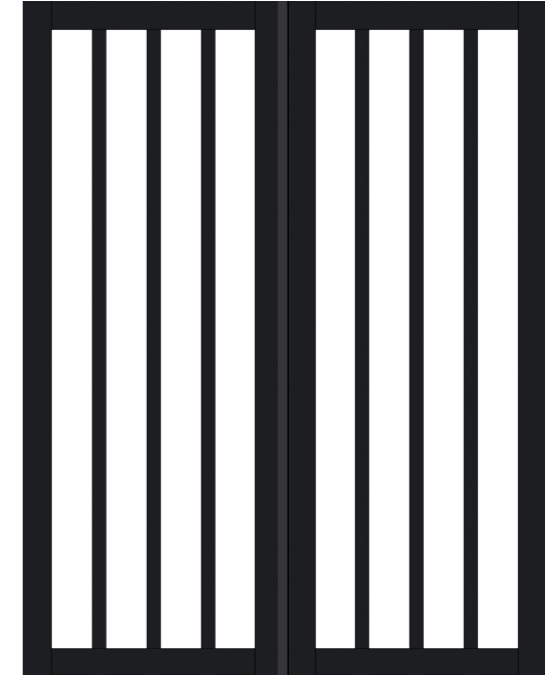

DD6427
LAGOS
PANEL

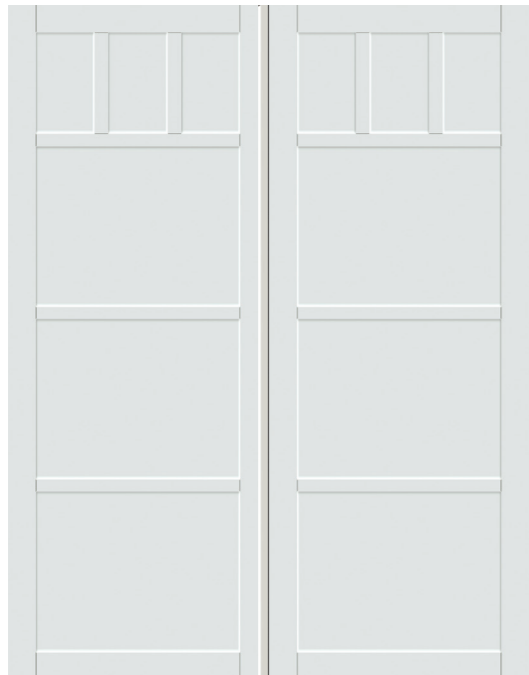

DD6427
LAGOS
PANEL & GLAZED

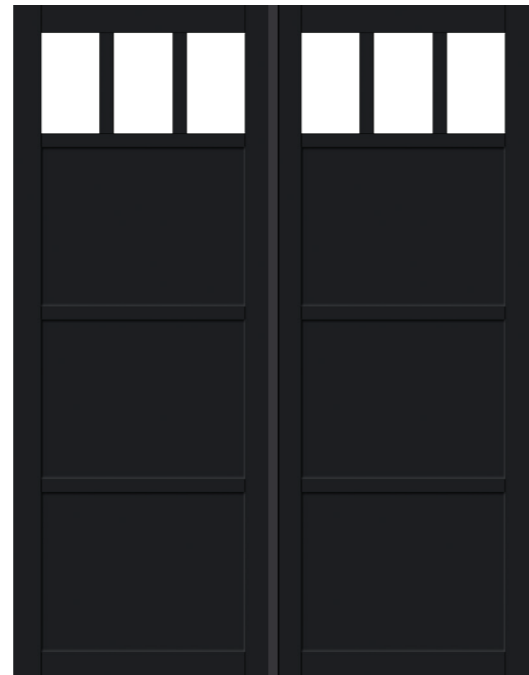

DD6433
CALEDONIA
PANEL



THRU-SLIDE Eco-Urban Doors: Designs - Double Doors

DD6437
MORNINGSIDE
PANEL



DD6437
MORNINGSIDE
GLAZED



THRU-SLIDE Eco-Urban Doors: Designs - Double Doors

DD6436
COLORADO
PANEL



DD6438
PORTOBELLO
GLAZED

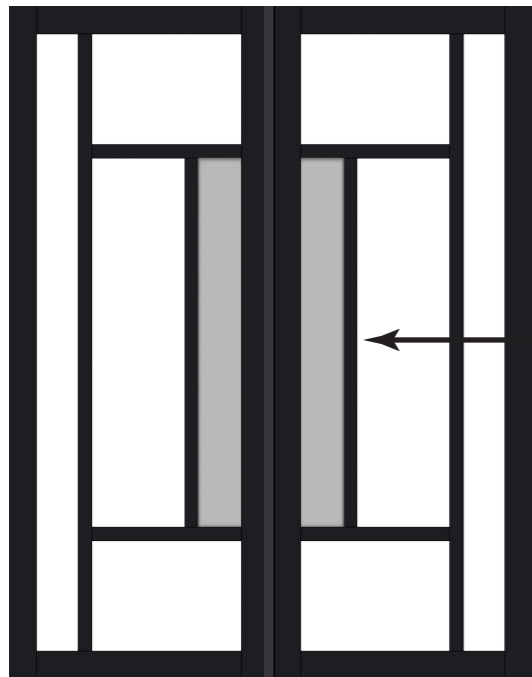

FROSTED
GLASS





THRU-SLIDE Eco-Urban Doors: Samples & Offer

Multi door discount available.

**If you require a color sample, please
get in touch with your supplier.**

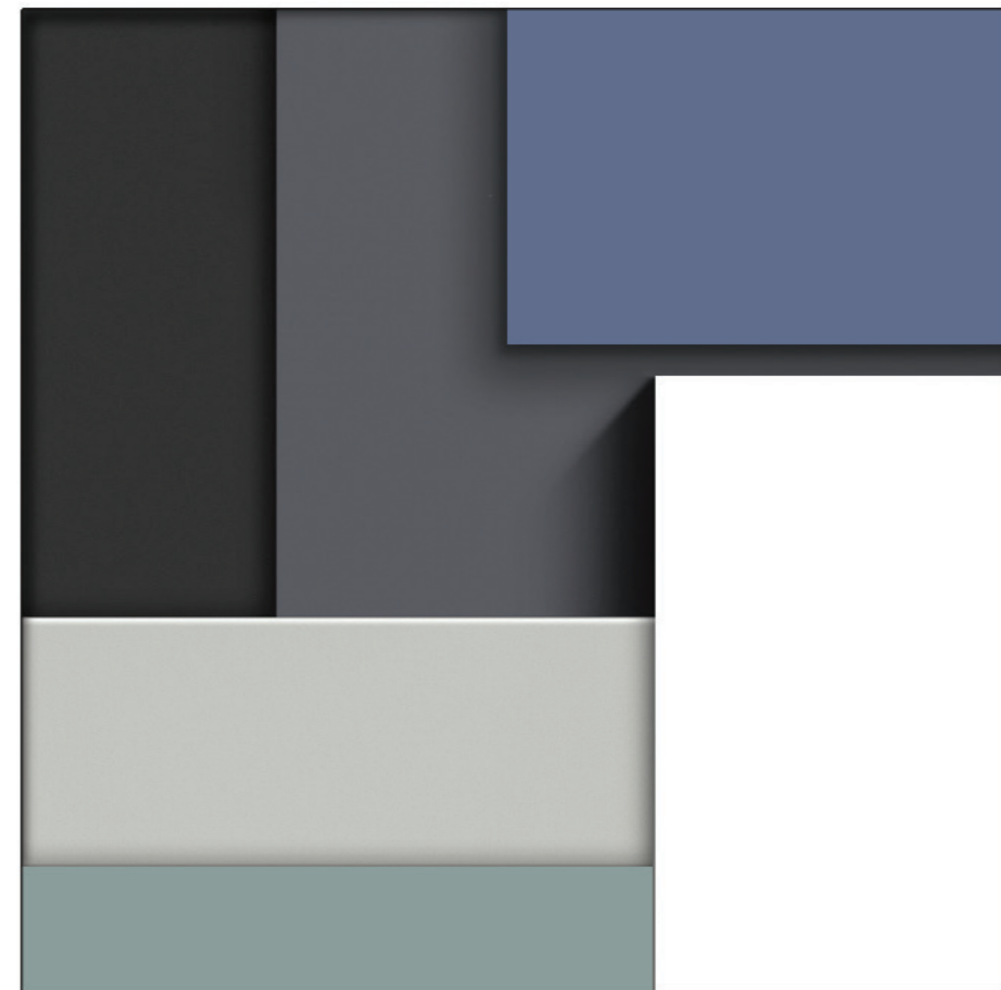

THRU-SLIDE Eco-Urban Doors: Handles Available

We offer a variety of handles that are designed to complement our Eco-Urban sliding doors. All of our handles are sold in multiple pairs, providing a cost-effective and convenient solution for your needs.



CHESTER
MATT BLACK
FHE204R-40/120-MBLK-1PR



CHESTER
SATIN STAINLESS STEEL
FHE204R-40/120-SSS-1PR



CHESTER
POLISHED STAINLESS STEEL
FHE204R-40/120-PSS-1PR



BURBANK
MATT BLACK
FHE203-35/120-MBLK-1PR



BURBANK
SATIN STAINLESS STEEL
FHE203-35/120-SSS-1PR



BURBANK
POLISHED STAINLESS STEEL
FHE203-35/120-BSS-1PR



ANNISTON
MATT BLACK
FHE201-50-MBLK-1PR

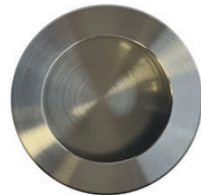

ANNISTON
SATIN STAINLESS STEEL
FHE201-50-SSS-1PR



ANNISTON
POLISHED STAINLESS STEEL
FHE201-50-PSS-1PR

THRU-SLIDE Eco-Urban Doors: Contact



Contact

+44 (0)1968 671 681
enquiries@directdoors.com

Delivery

Our standard delivery service is operating for almost all products, albeit some may have slight delays that are subject to change due to supply source issues. Our aim is to dispatch all orders with a minimum of delay.

We provide tailored support and exceptional service, creating a bespoke door experience that makes our clients feel valued and cared for. We aim to build long-term relationships built on trust and mutual respect.





ThruSlide
ECO
URBAN

