

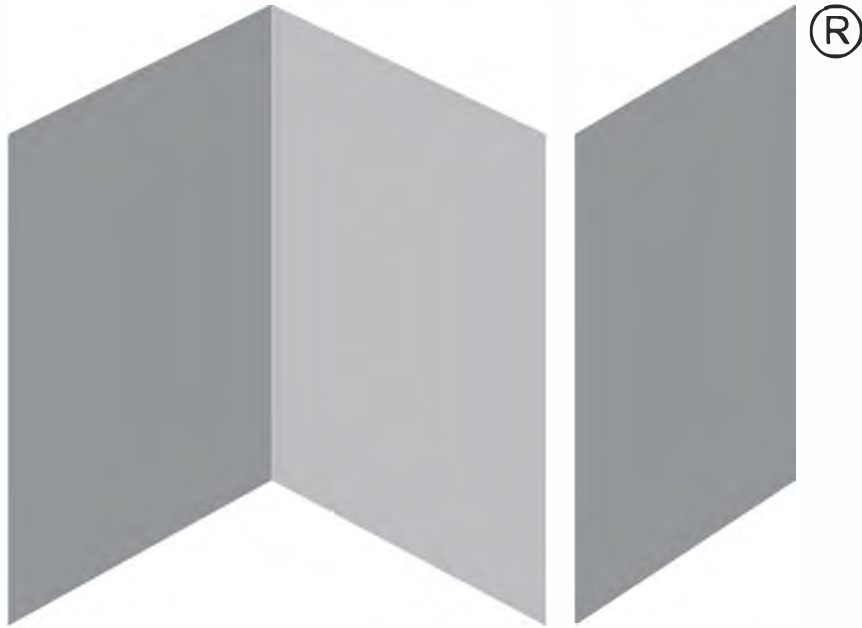

Trade, DIY, Bulk



T H R U F ● L D

DirectDoors.com

All content and images are copyright protected by DirectDoors.com

Intellectual Property Office Trademark

No: UK00003238454

Page 1

DOOR CONFIGURATIONS & SIZES AT A GLANCE

DOOR CONFIGURATION	DOOR WIDTH OPTIONS	OVERALL WIDTH WITHOUT FRAME	OVERALL WIDTH INC. FRAME	OVERALL HEIGHT WITHOUT FRAME	OVERALL HEIGHT INC. FRAME
2 + 0	686mm	1385mm	1445mm	2054mm	2084mm
2 + 0	762mm	1537mm	1597mm	2054mm	2084mm
2 + 0	838mm	1689mm	1749mm	2054mm	2084mm
2 + 1	686mm	2076mm	2136mm	2054mm	2084mm
2 + 1	762mm	2304mm	2364mm	2054mm	2084mm
2 + 1	838mm	2532mm	2592mm	2054mm	2084mm
2 + 2	686mm	2765mm	2825mm	2054mm	2084mm
2 + 2	762mm	3069mm	3129mm	2054mm	2084mm
2 + 2	838mm	3373mm	3433mm	2054mm	2084mm
3 + 0	686mm	2074mm	2134mm	2054mm	2084mm
3 + 0	762mm	2302mm	2362mm	2054mm	2084mm
3 + 0	838mm	2530mm	2590mm	2054mm	2084mm
3 + 1	686mm	2765mm	2825mm	2054mm	2084mm
3 + 1	762mm	3069mm	3129mm	2054mm	2084mm
3 + 1	838mm	3373mm	3433mm	2054mm	2084mm
3 + 2	686mm	3454mm	3514mm	2054mm	2084mm
3 + 2	762mm	3834mm	3894mm	2054mm	2084mm
3 + 2	838mm	4214mm	4274mm	2054mm	2084mm
3 + 3	686mm	4143mm	4203mm	2054mm	2084mm
3 + 3	762mm	4599mm	4659mm	2054mm	2084mm
3 + 3	838mm	5055mm	5115mm	2054mm	2084mm

Frame materials may be supplied slightly oversized for on-site cutting, please refer to cutting size.

IMPORTANT THURFOLD INFORMATION

Please be aware that each image or PDF's for our internal folding doors show a position of a flush pull, hinges, slip bolt etc but the position of each item is very dependent on how you and your carpenter decide the doors should open.

There will be occasions when you may decide that the flush pull is better fitted in the centre of the middle door for a 3 door set or indeed a latch handle is fitted on the main opening door, the slip bolt must be fitted, but every other decision is yours to make - just decide before fitting.

The small door stops (25x12mm) for some of the configurations will have to be "offset" so one leg allows the main door to close against it in a traditional manner whereas the same door stop will be fitted on the opposite side at the other frame leg.

Walnut veneered doors are supplied with white primed frames and associated material, walnut veneered frames are not available but we could supply unfinished oak frames at an extra cost to allow you to stain them.

Unfinished and prefinished oak veneer doors are supplied with unfinished oak veneer frames and associated material.

White primed, white painted or coloured doors (Grey/Ivory/Laminates etc) are supplied with white primed frames and associated material.

Any mention of pre-finished, pre-finishing or fully varnished refers to the door alone.

Please note that we may use narrower doors for some sizes of this product whether panelled or glazed, they may have narrower panels or glass than the image shown, this is because the timber sections that make up the doors construction remain the same size across the full range of door sizes.

COMPONENT LIST

2+0

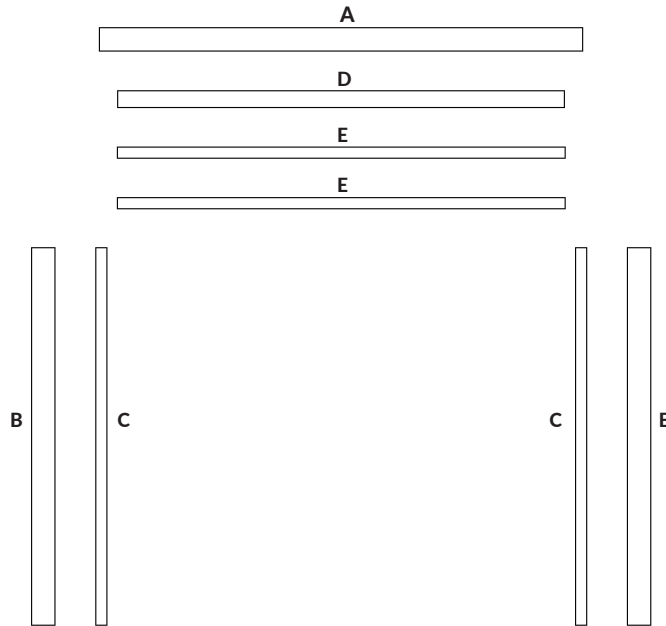

Frame linings are an MDF solid core construction.

FRAME LINTOL	A - x1
FRAME SIDE/LEG	B - x2
FRAME STOP	C - x2
PELMET	D - x1
TRACK COVER	E - x2

Screws & Screw Caps:





 FRAME SCREW x5

 TRACK COVER SCREW & CAP x8

PINS FOR PELMET & FRAME STOPS INCLUDED

(extra screws, screw caps and pins are supplied)

The items below will be delivered from our preferred track supplier.

ALUMINIUM TOP TRACK	x1
PIVOT SET 	x1
TWO WHEEL HANGER 	x1
HINGES 	x3
SURFACES BOLT 	x1

COMPONENT LIST

2+1

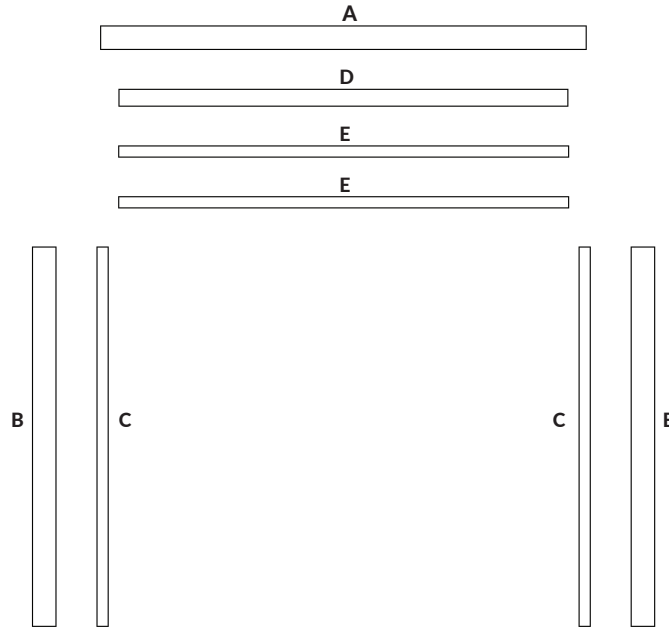

Frame linings are an MDF solid core construction.

FRAME LINTOL	A - x1
FRAME SIDE/LEG	B - x2
FRAME STOP	C - x2
PELMET	D - x1
TRACK COVER	E - x2





Screws & Screw Caps:

 FRAME SCREW x5

 TRACK COVER SCREW & CAP x10

PINS FOR PELMET & FRAME STOPS INCLUDED
(extra screws, screw caps and pins are supplied)

The items below will be delivered from our preferred track supplier.

ALUMINIUM TOP TRACK	x1
PIVOT SET 	x2
TWO WHEEL HANGER 	x1
HINGES 	x3
SURFACES BOLT 	x1

COMPONENT LIST

2+2

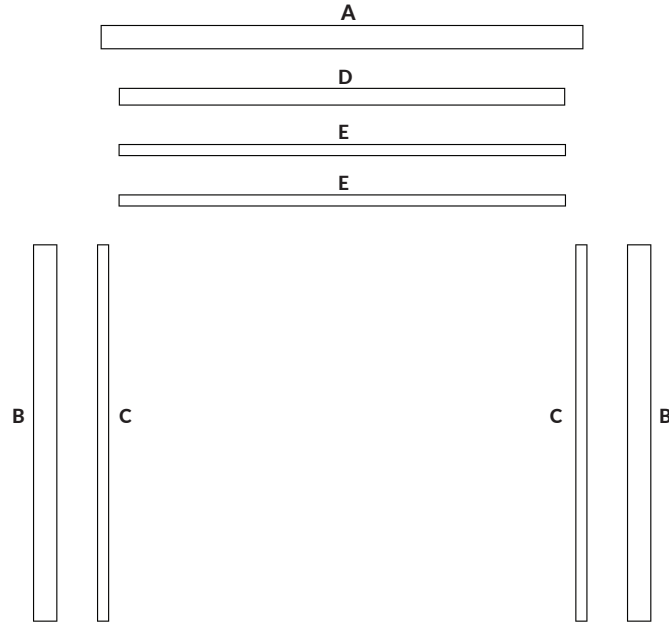

Frame linings are an MDF solid core construction.

FRAME LINTOL	A - x1
FRAME SIDE/LEG	B - x2
FRAME STOP	C - x2
PELMET	D - x1
TRACK COVER	E - x2

Screws & Screw Caps:





 FRAME SCREW x5

 TRACK COVER SCREW & CAP x12

PINS FOR PELMET & FRAME STOPS INCLUDED

(extra screws, screw caps and pins are supplied)

The items below will be delivered from our preferred track supplier.

ALUMINIUM TOP TRACK		x1
PIVOT SET		x2
TWO WHEEL HANGER		x2
HINGES		x6
SURFACES BOLT		x2

COMPONENT LIST

3+0

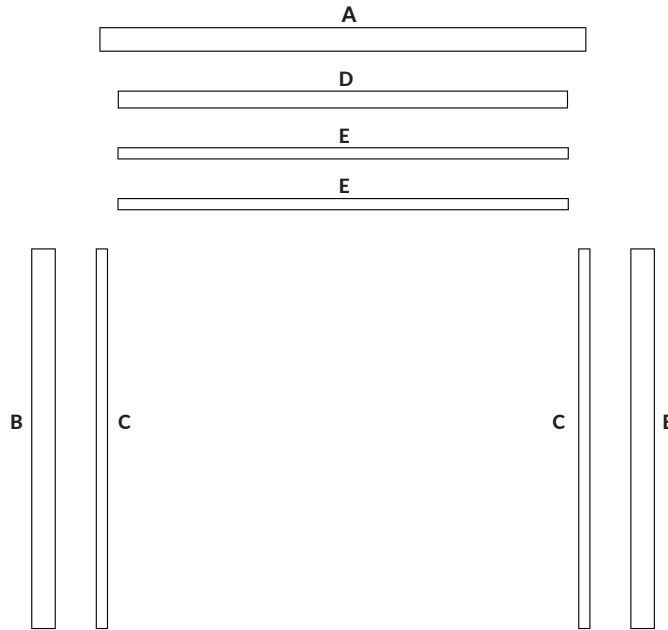

Frame linings are an MDF solid core construction.

FRAME LINTOL	A - x1
FRAME SIDE/LEG	B - x2
FRAME STOP	C - x2
PELMET	D - x1
TRACK COVER	E - x2

Screws & Screw Caps:

-  FRAME SCREW x5
-  TRACK COVER SCREW & CAP x10
- PINS FOR PELMET & FRAME STOPS INCLUDED

The items below will be delivered from our preferred track supplier.

ALUMINIUM TOP TRACK	x1
PIVOT SET	x1
FOUR WHEEL HANGER	x1
HINGES	x6
SURFACES BOLT	x2

Not to scale, dimensions will vary depending on the option chosen.

COMPONENT LIST

3+1

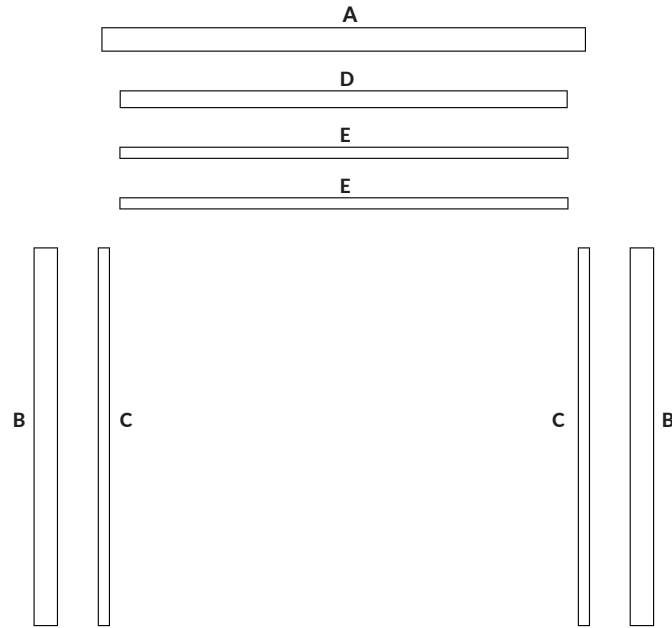

Frame linings are an MDF solid core construction.

FRAME LINTOL	A - x1
FRAME SIDE/LEG	B - x2
FRAME STOP	C - x2
PELMET	D - x1
TRACK COVER	E - x2

Screws & Screw Caps:





 FRAME SCREW x5

 TRACK COVER SCREW & CAP x12

PINS FOR PELMET & FRAME STOPS INCLUDED

(extra screws, screw caps and pins are supplied)

The items below will be delivered from our preferred track supplier.

ALUMINIUM TOP TRACK		x1
PIVOT SET		x2
FOUR WHEEL HANGER		x1
HINGES		x6
SURFACES BOLT		x3

Not to scale, dimensions will vary depending on the option chosen.

COMPONENT LIST

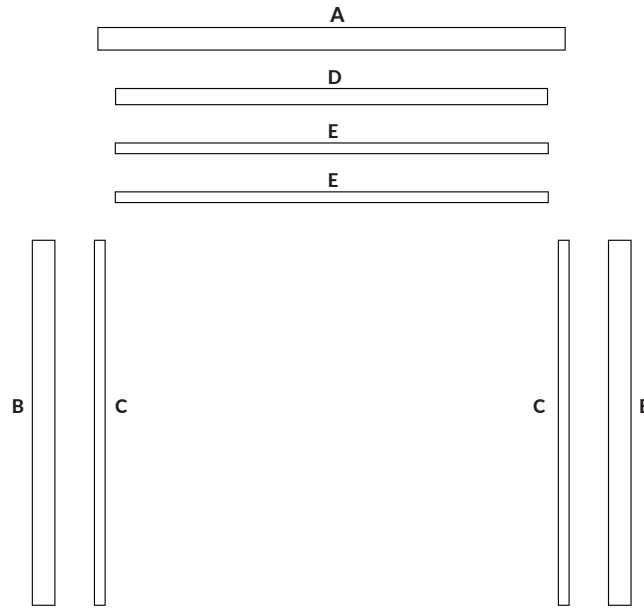

3+2









Frame linings are an MDF solid core construction.

FRAME LINTOL	A - x1
FRAME SIDE/LEG	B - x2
FRAME STOP	C - x2
PELMET	D - x1
TRACK COVER	E - x2

Screws & Screw Caps:

-  FRAME SCREW x5
-  TRACK COVER SCREW & CAP x14
- PINS FOR PELMET & FRAME STOPS INCLUDED
(extra screws, screw caps and pins are supplied)

The items below will be delivered from our preferred track supplier.

ALUMINIUM TOP TRACK		x1
PIVOT SET		x2
TWO WHEEL HANGER		x1
FOUR WHEEL HANGER		x1
HINGES		x9
SURFACES BOLT		x3

COMPONENT LIST

3+3

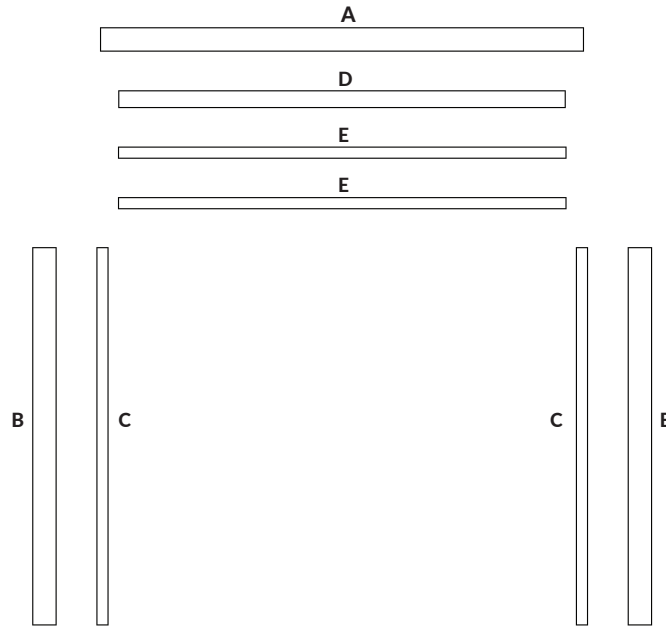

Frame linings are an MDF solid core construction.

FRAME LINTOL	A - x1
FRAME SIDE/LEG	B - x2
FRAME STOP	C - x2
PELMET	D - x1
TRACK COVER	E - x2

Screws & Screw Caps:





 FRAME SCREW x5

 TRACK COVER SCREW & CAP x14

PINS FOR PELMET & FRAME STOPS INCLUDED

(extra screws, screw caps and pins are supplied)

The items below will be delivered from our preferred track supplier.

ALUMINIUM TOP TRACK		x1
PIVOT SET		x2
FOUR WHEEL HANGER		x2
HINGES		x12
SURFACES BOLT		x4

IMPORTANT

Please note: You can only assemble these door configurations by using the frame provided. Your warranty will be invalid if other alternatives are used.

All loads are taken by the top track to ensure smooth, light operation and long life.

Prior to installing this doorset, inspect for damage and do not proceed to fit if any noticeable damage or defect is evident. This doorset should be stored in a dry flat location before installation.

CAUTION



SAFETY: This product needs to be installed by a competent tradesperson with assistance. Two people are required to carry out the installation, as some components are heavy.

The outer frame requires fixing to the supporting structure above the opening.

The opening **MUST** be capable of carrying the load of the doorset in all conditions.

FRAME 133x30mm

SECTION H - H

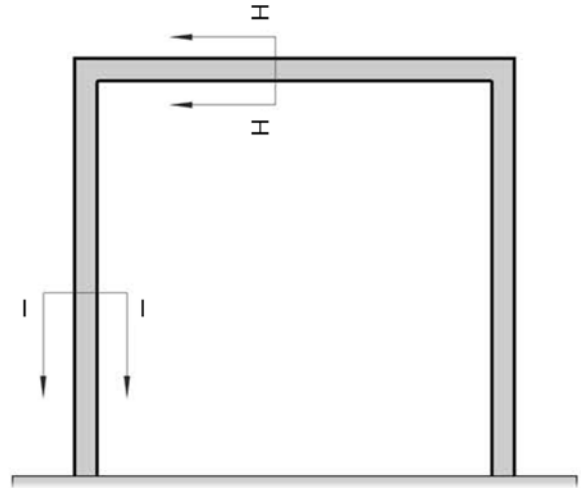
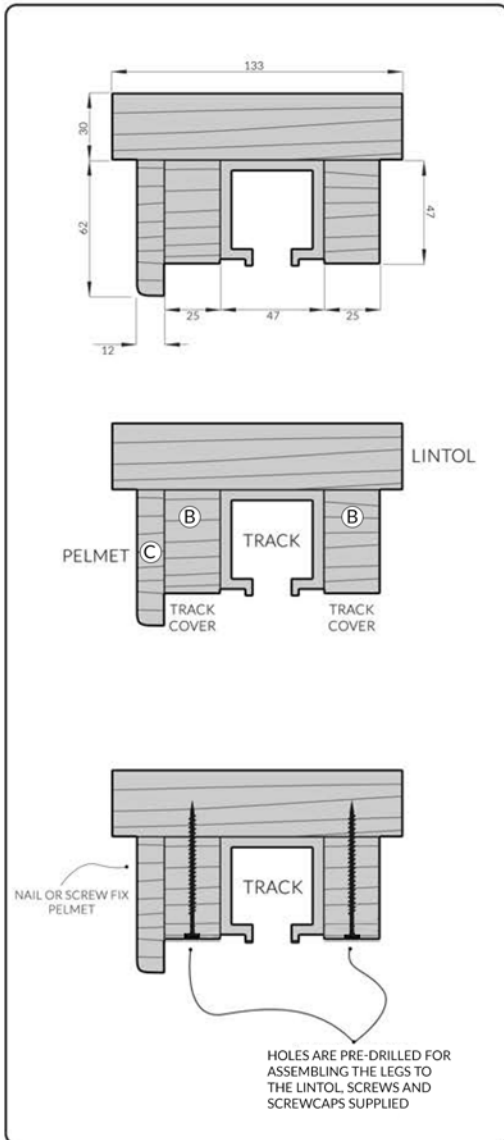

SECTION I - I

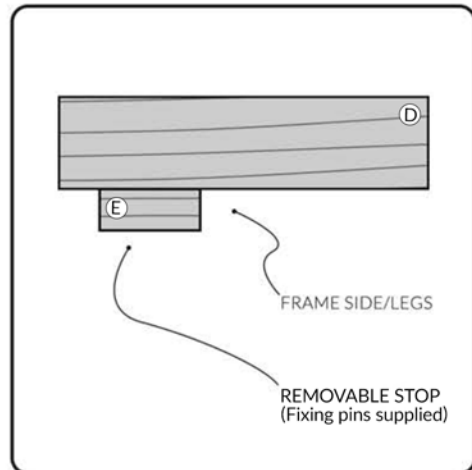

- Ⓐ Frame lintol
- Ⓑ Track covers
- Ⓒ Pelmet
- Ⓓ Frame Legs
- Ⓔ Door stops

FRAME MUST BE PERFECTLY ALIGNED ON ALL THREE AXIS

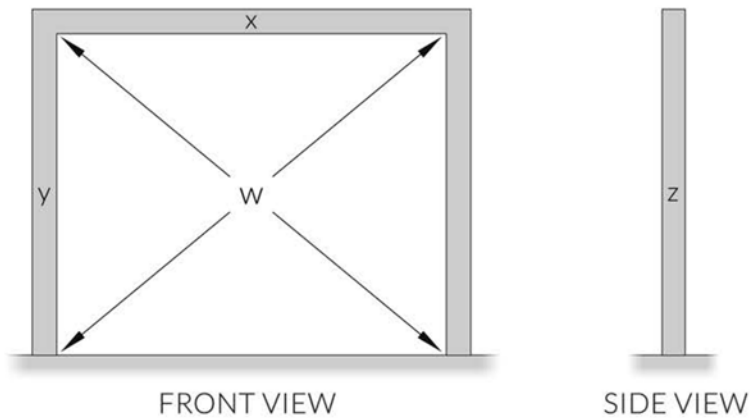

X: horizontal. Y: vertical. Z: lateral = all must be true

W = must be perfectly symmetrical/square

FRAME 108x30mm

SECTION H - H

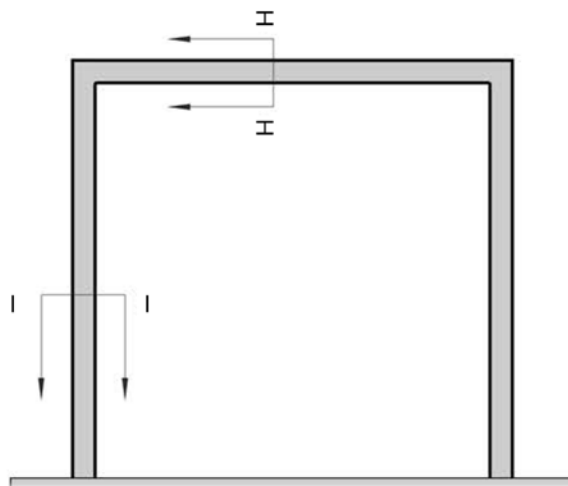
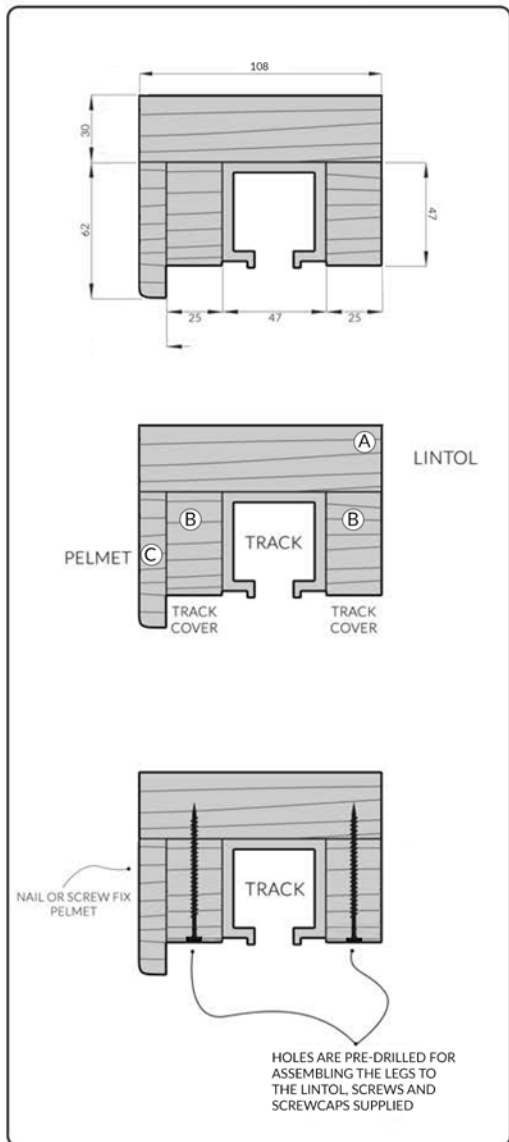

SECTION I - I

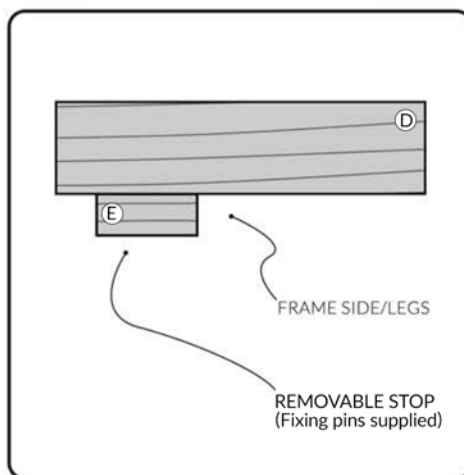

- Ⓐ Frame lintol
- Ⓑ Track covers
- Ⓒ Pelmet
- Ⓓ Frame Legs
- Ⓔ Door Stops

FRAME MUST BE PERFECTLY ALIGNED ON ALL THREE AXIS

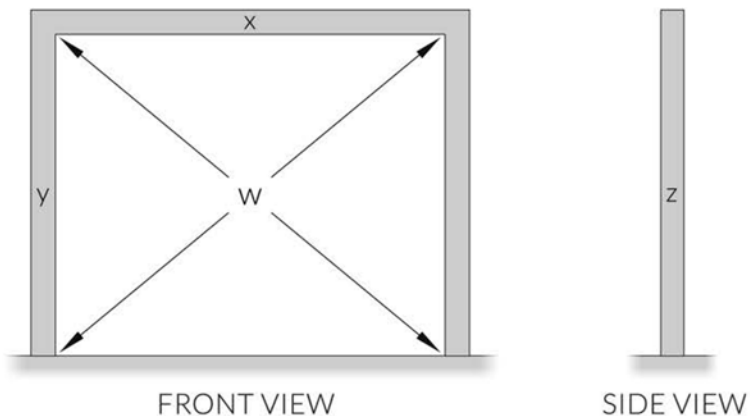

X: horizontal. Y: vertical. Z: lateral = all must be true
 W = must be perfectly symmetrical/square

JOINING FRAME LEGS TO LINTOL.

Frame Legs and Lintol may be longer than required.

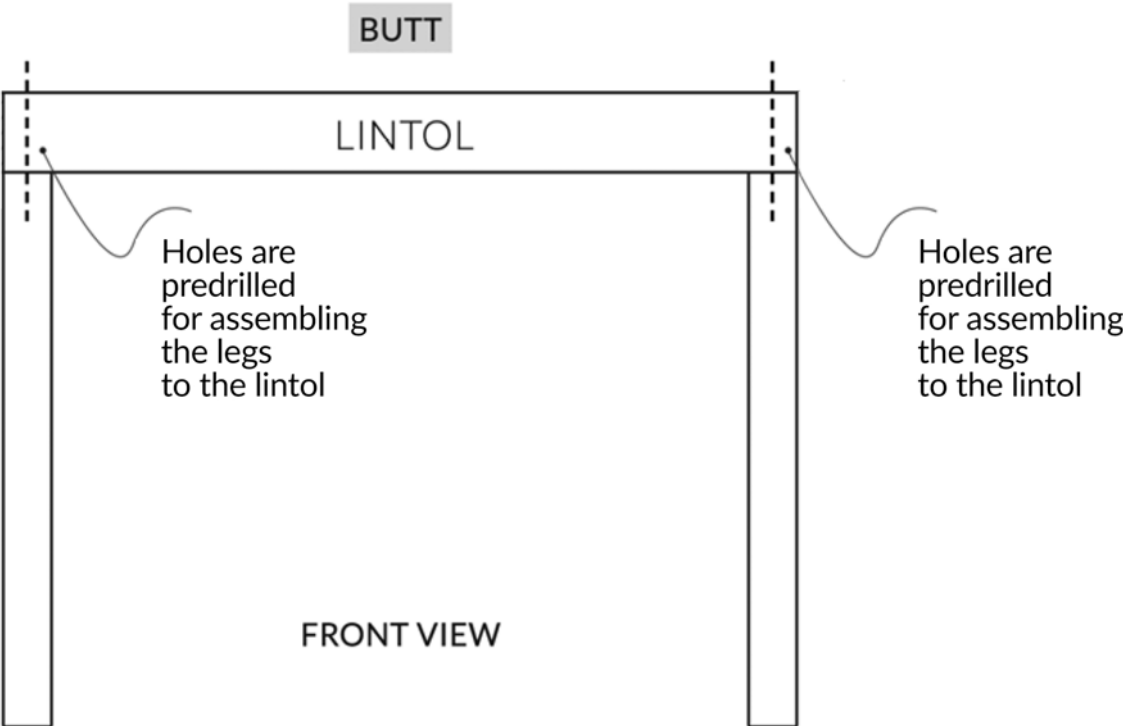

DOOR CONFIGURATION OPTIONS

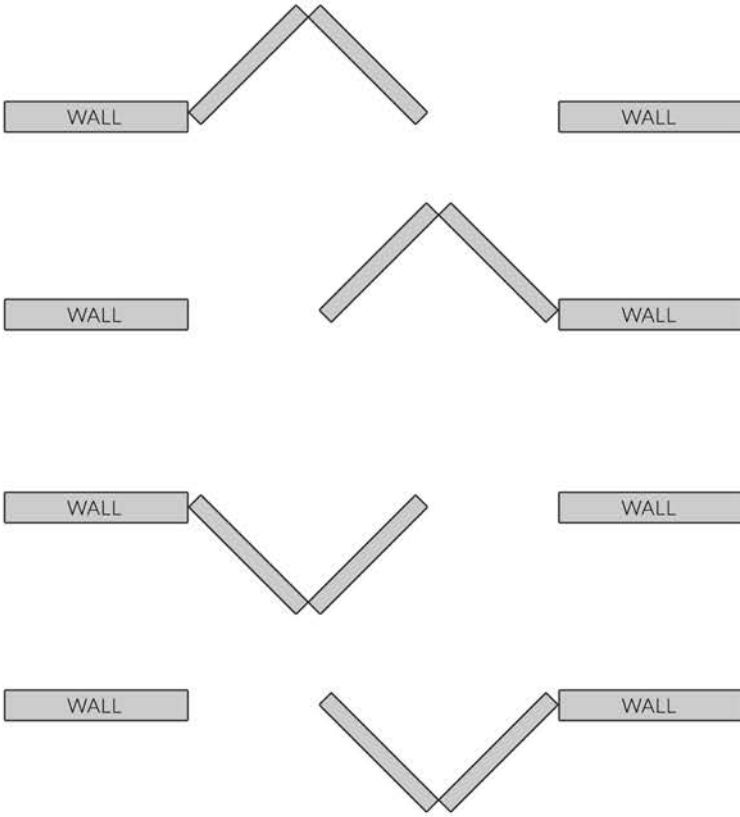

DOOR HARDWARE ORIENTATION

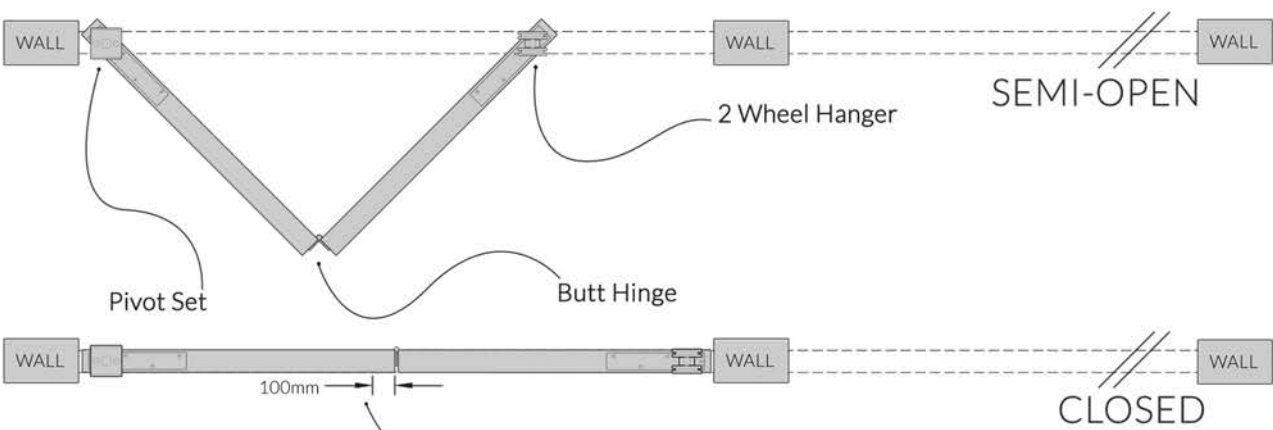

Surface Bolt
 Position is dependent on your preferred door configuration/operation.
 Any surface bolt(s) should be fitted to the bottom of correct door,
 please see **page 28**.

DOOR CONFIGURATION OPTIONS

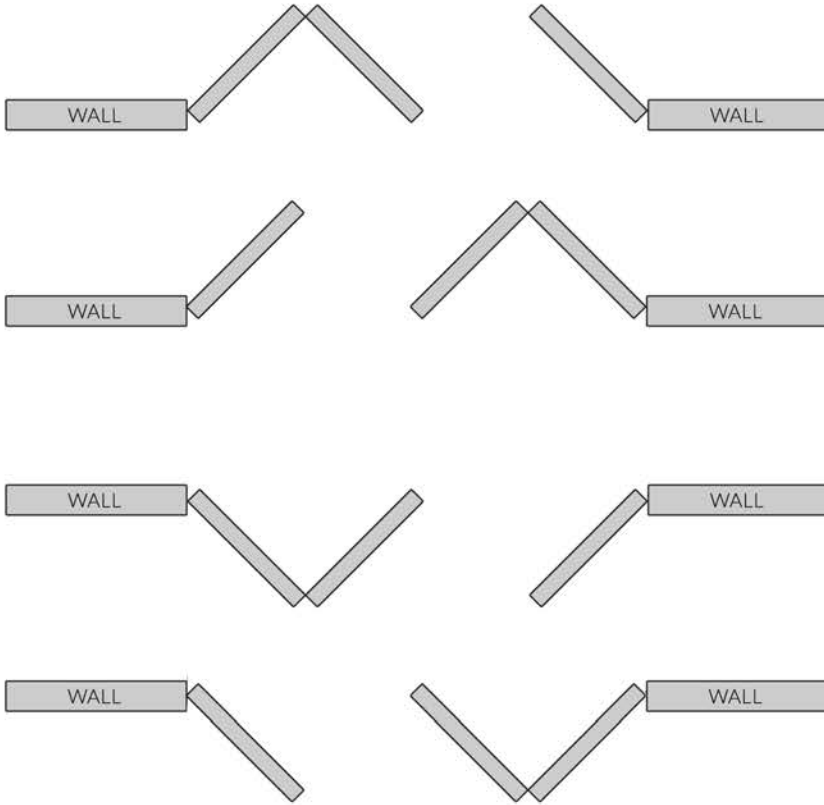

DOOR HARDWARE ORIENTATION

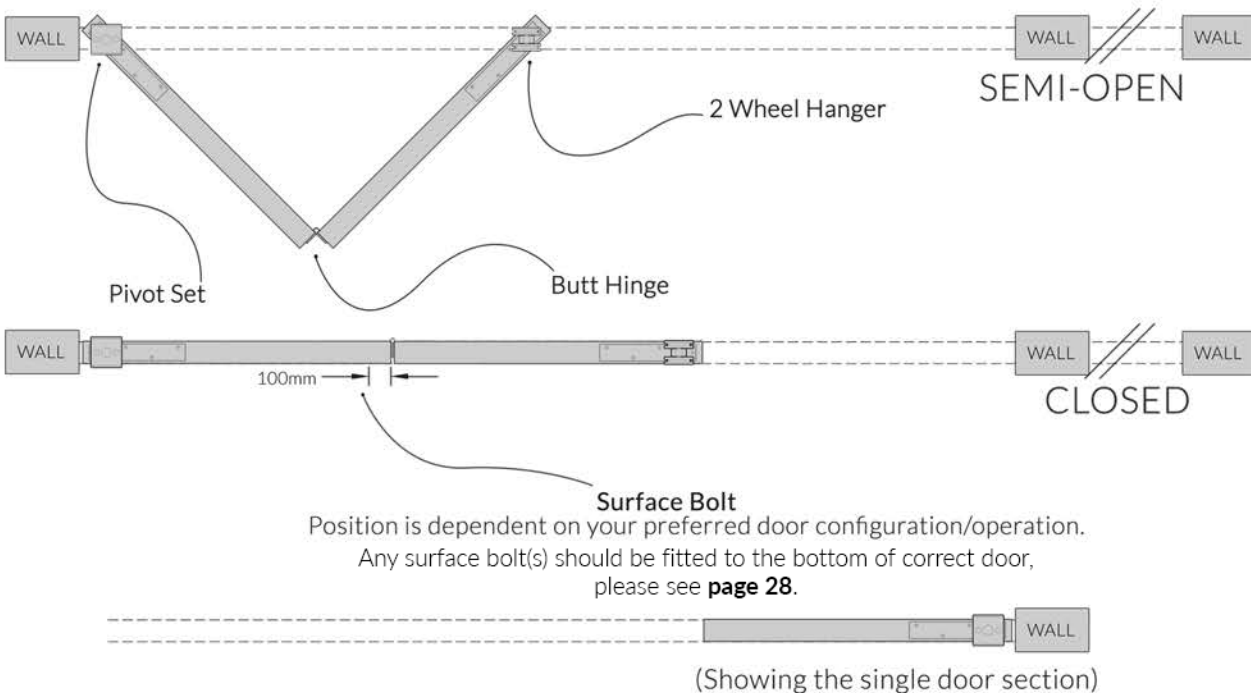

2 + 2

DOOR CONFIGURATION

DOOR CONFIGURATION OPTIONS

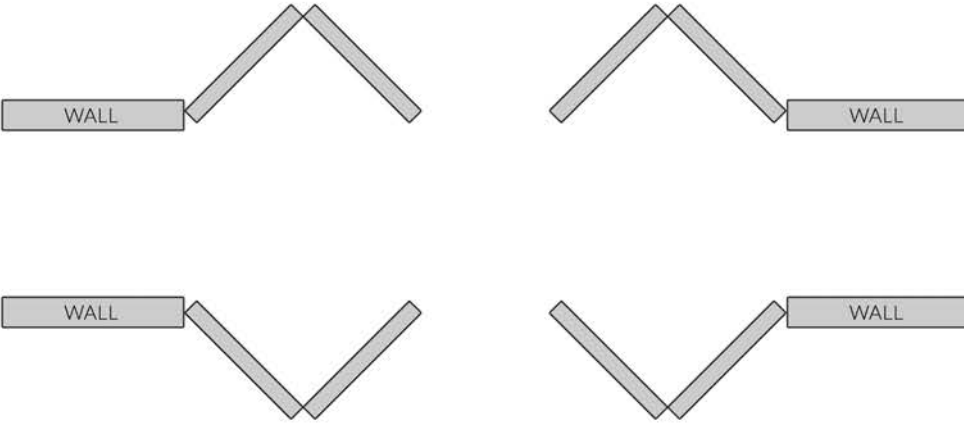

DOOR HARDWARE ORIENTATION

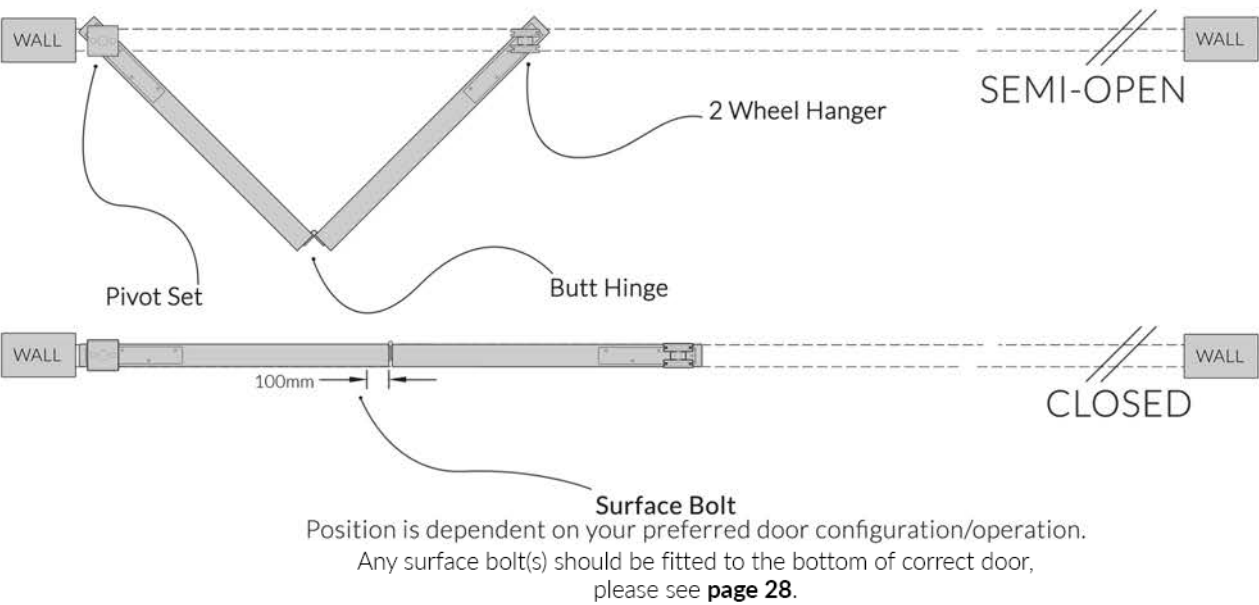

(Images showing half of the full set)

DOOR CONFIGURATION OPTIONS

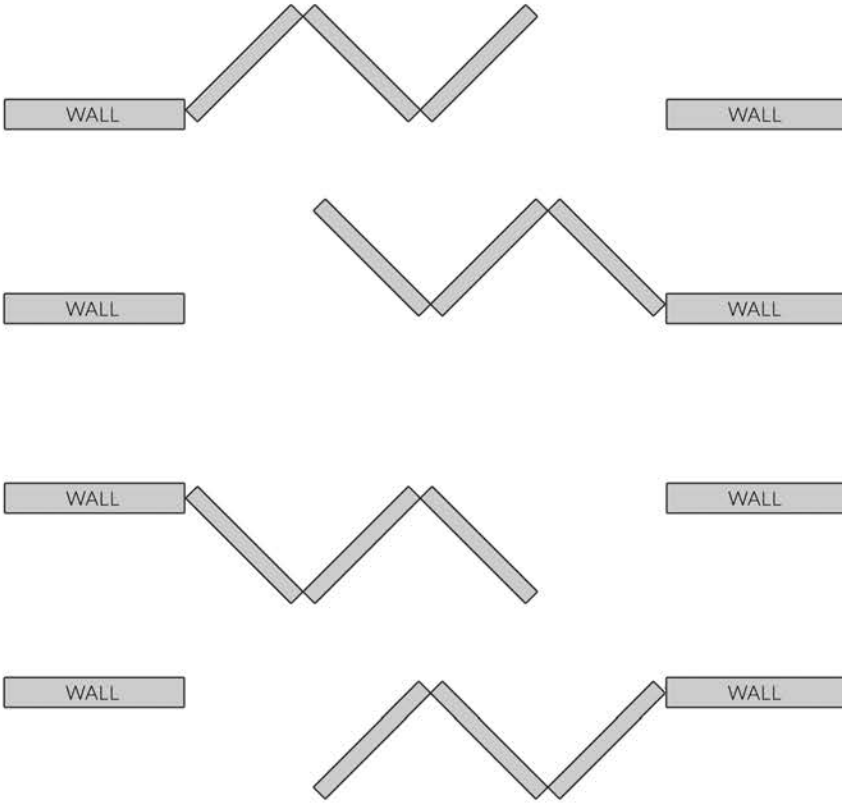

DOOR HARDWARE ORIENTATION

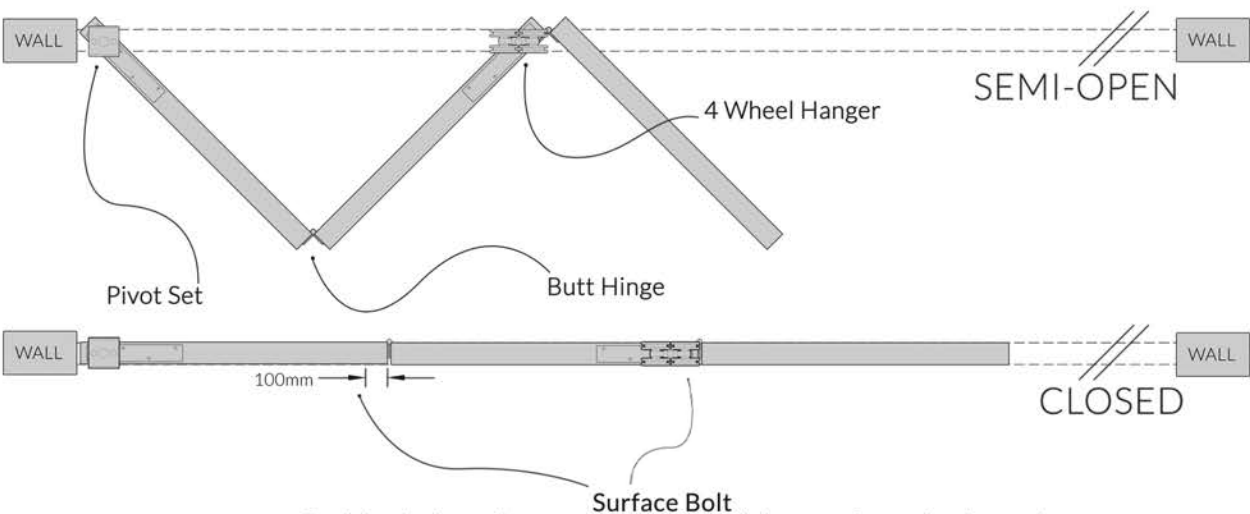

Position is dependent on your preferred door configuration/operation.
 Any surface bolt(s) should be fitted to the bottom of correct door,
 please see **page 28**.

DOOR CONFIGURATION OPTIONS

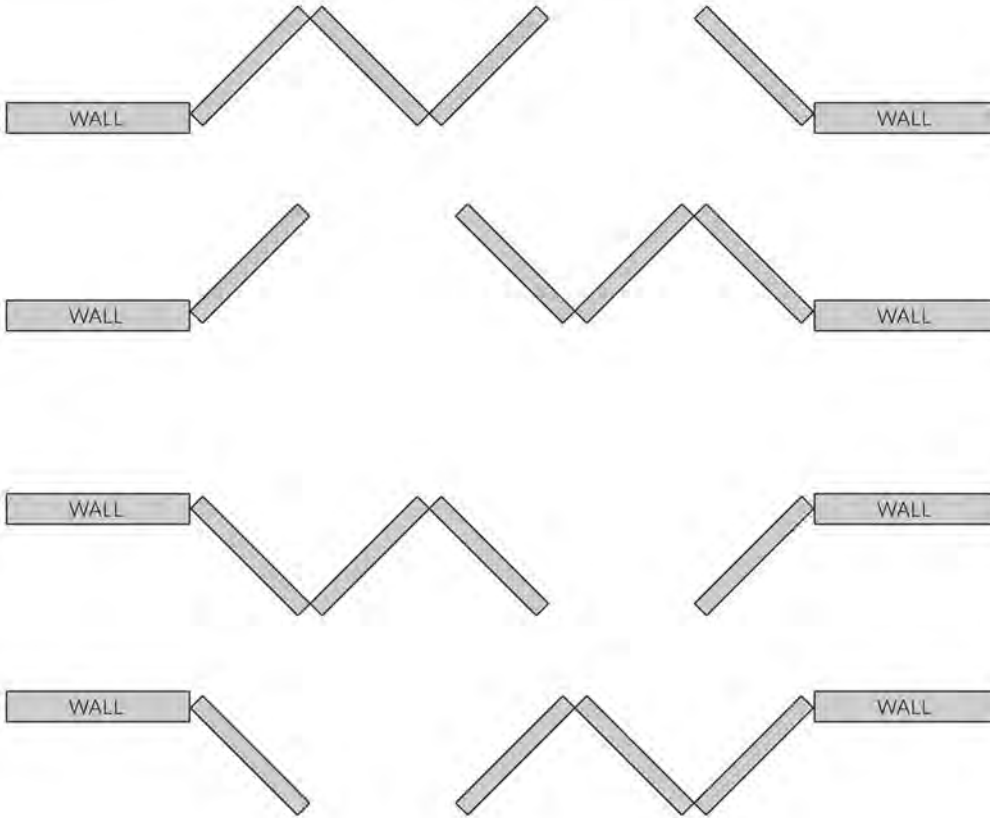

DOOR HARDWARE ORIENTATION

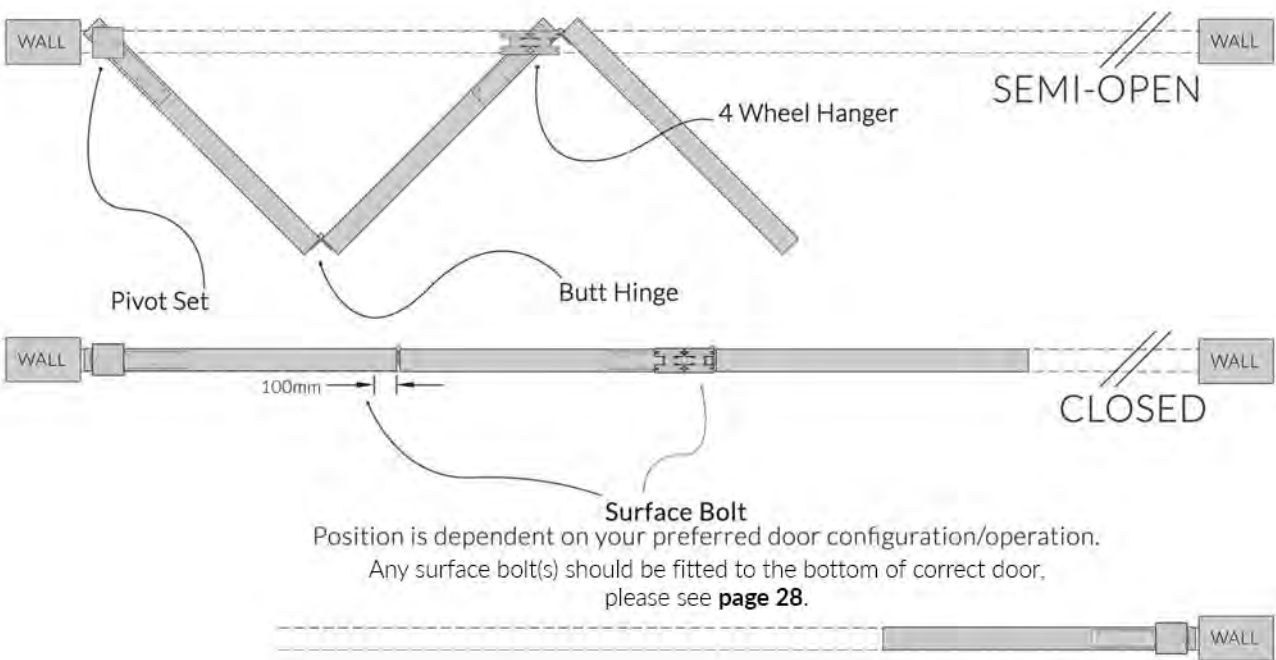

(Showing the single door section)

DOOR CONFIGURATION OPTIONS

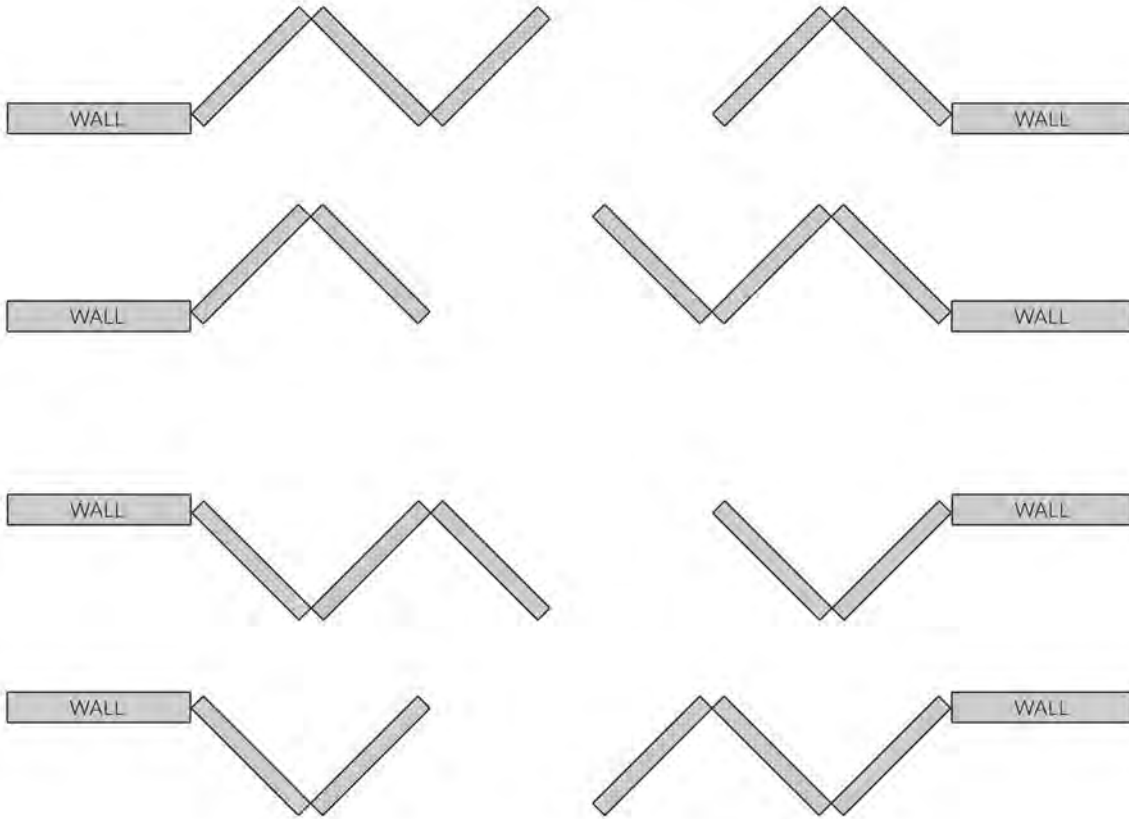

DOOR HARDWARE ORIENTATION

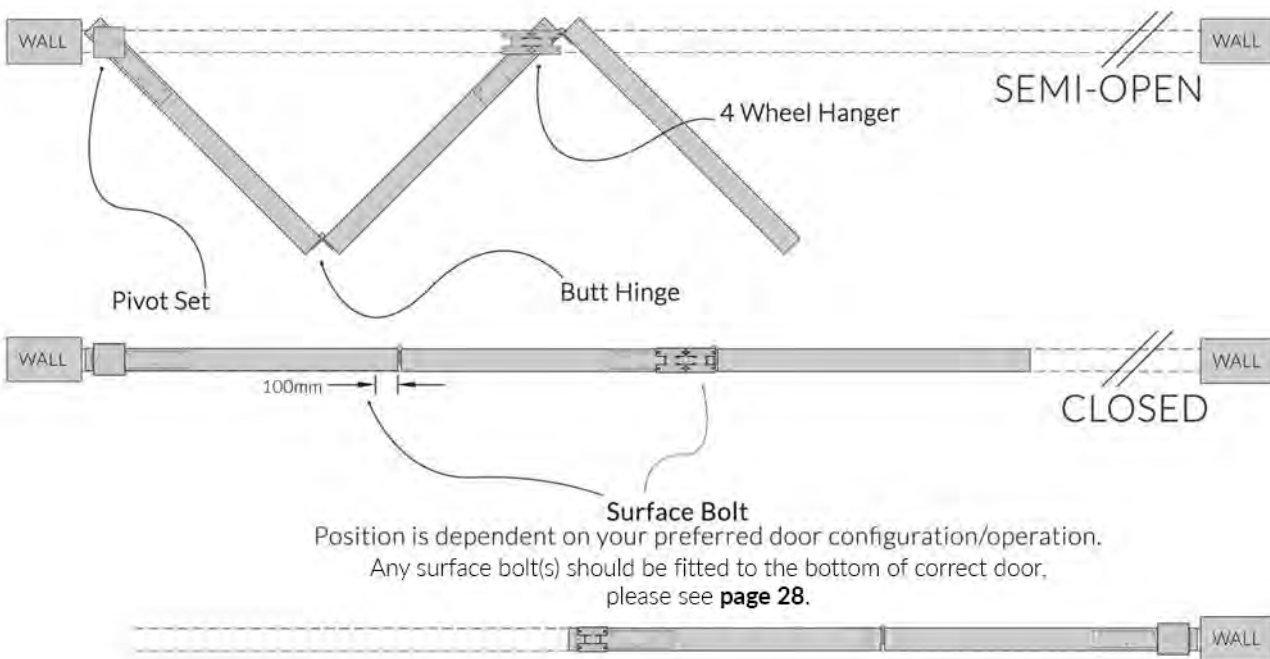

Position is dependent on your preferred door configuration/operation.
 Any surface bolt(s) should be fitted to the bottom of correct door,
 please see **page 28**.

(Showing the double door section)

3 + 3

DOOR CONFIGURATION

DOOR CONFIGURATION OPTIONS

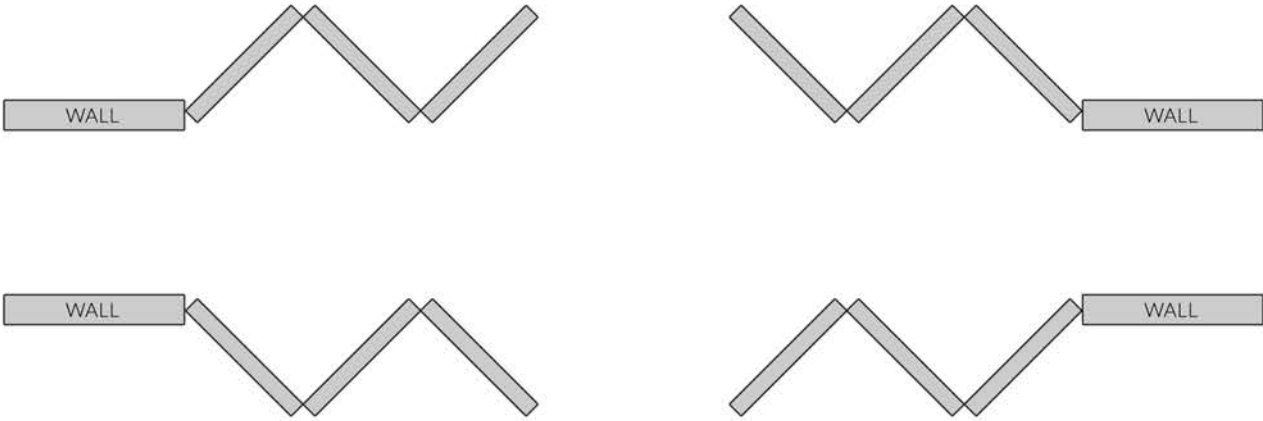

DOOR HARDWARE ORIENTATION

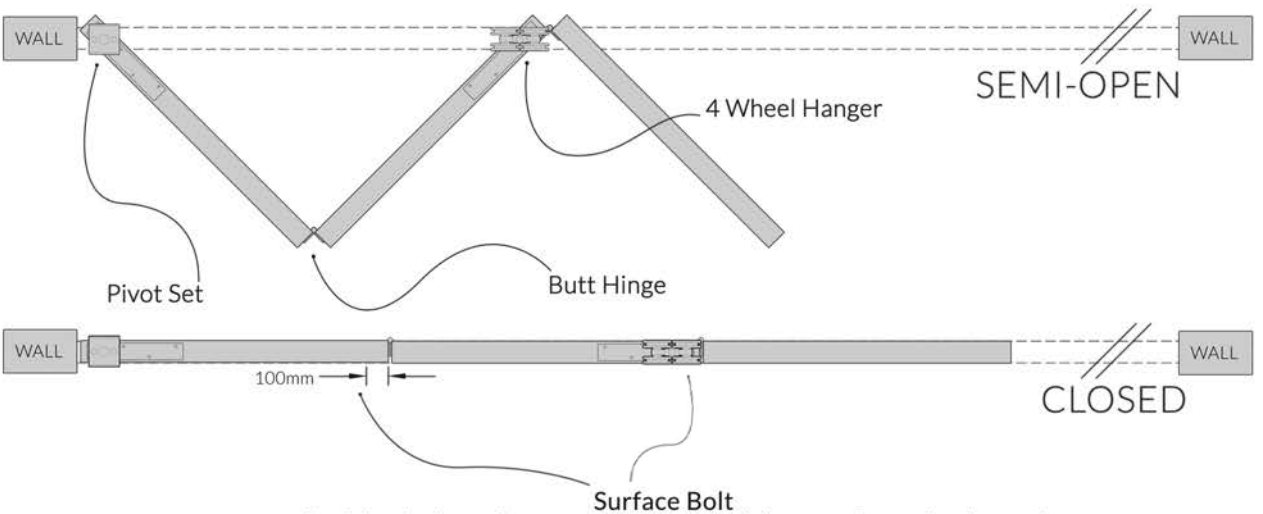

Position is dependent on your preferred door configuration/operation.
 Any surface bolt(s) should be fitted to the bottom of correct door,
 please see **page 28**.

(Images showing half of the full set)

SECTION A-A

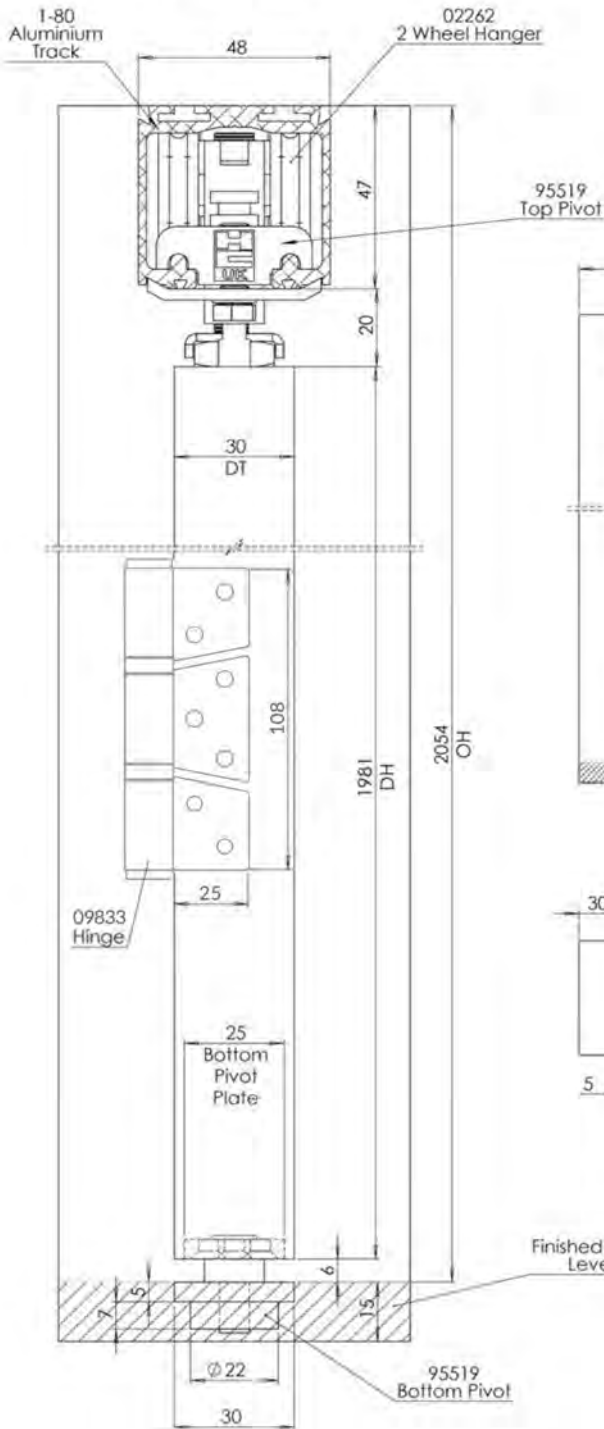

Front View

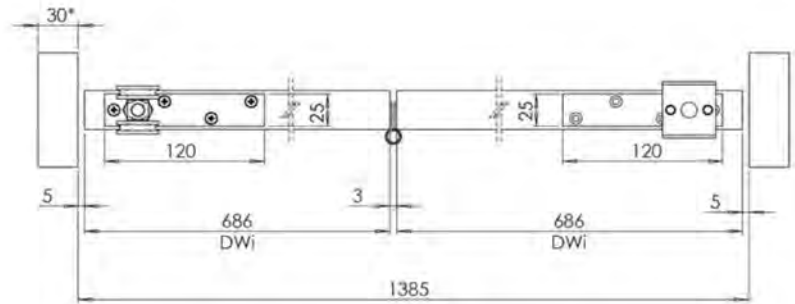
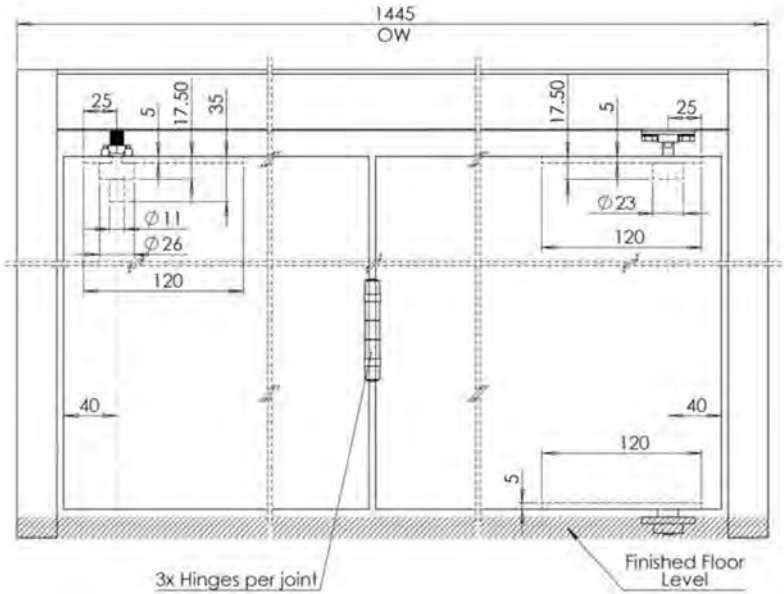

Maximum door weight 50kg
 DH - Door height, maximum door height 3000mm
 DWi - Door width, maximum 850mm
 DT - Door thickness between 30mm and 50mm
 OW - Opening width
 OH - Opening height
 * - Recommended value

09833
1x Hinge pack



Typical hinge styles used

SECTION A-A

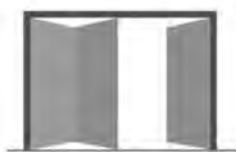
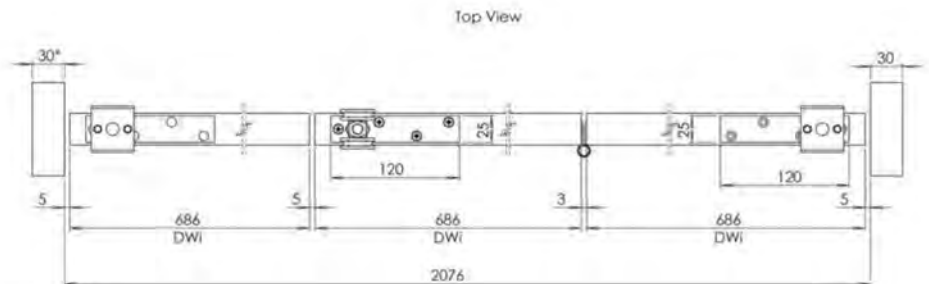
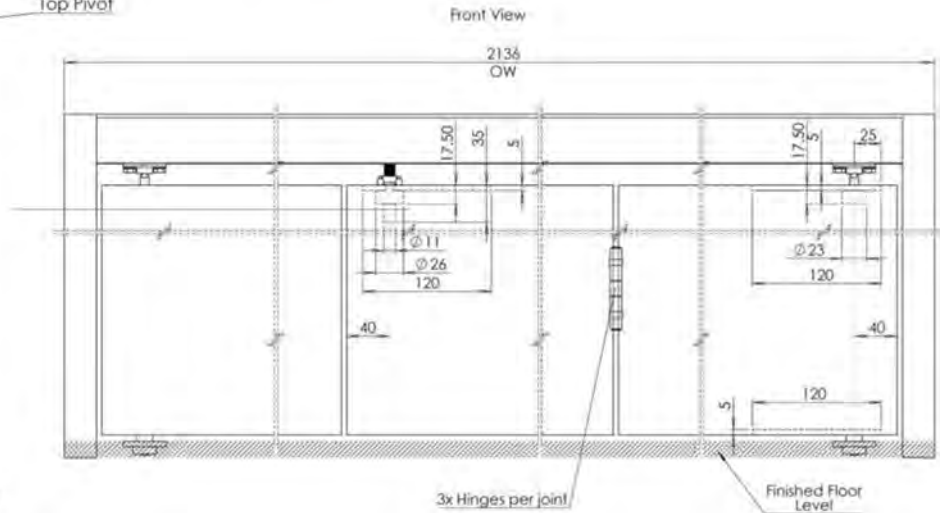
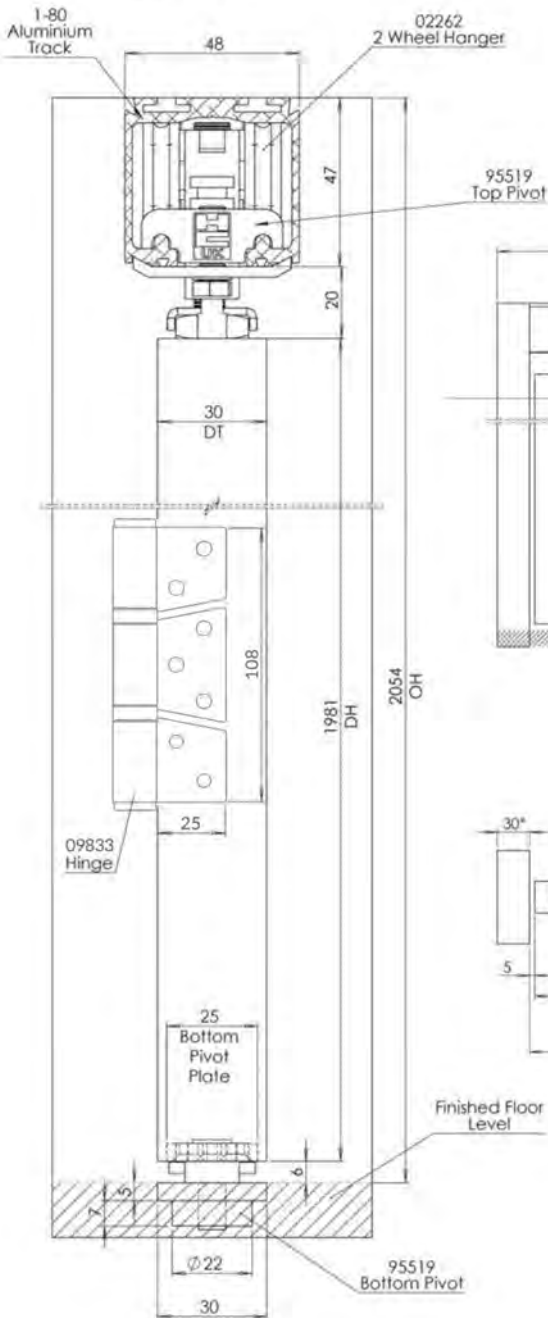

Maximum door weight 50kg
 DH - Door height, maximum door height 3000mm
 DWI - Door width, maximum 850mm
 DT - Door thickness between 30mm and 50mm
 OW - Opening width
 OH - Opening height
 * - Recommended value

SECTION A-A

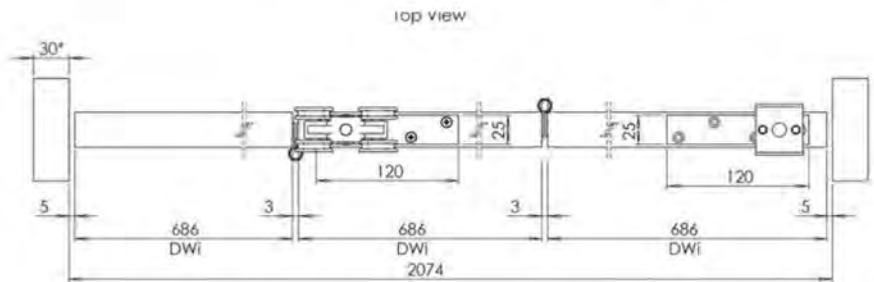
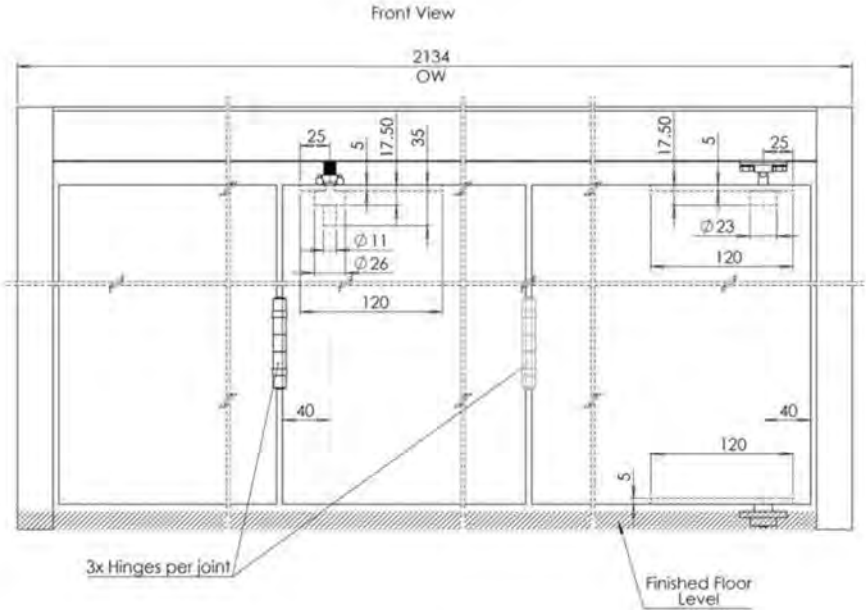
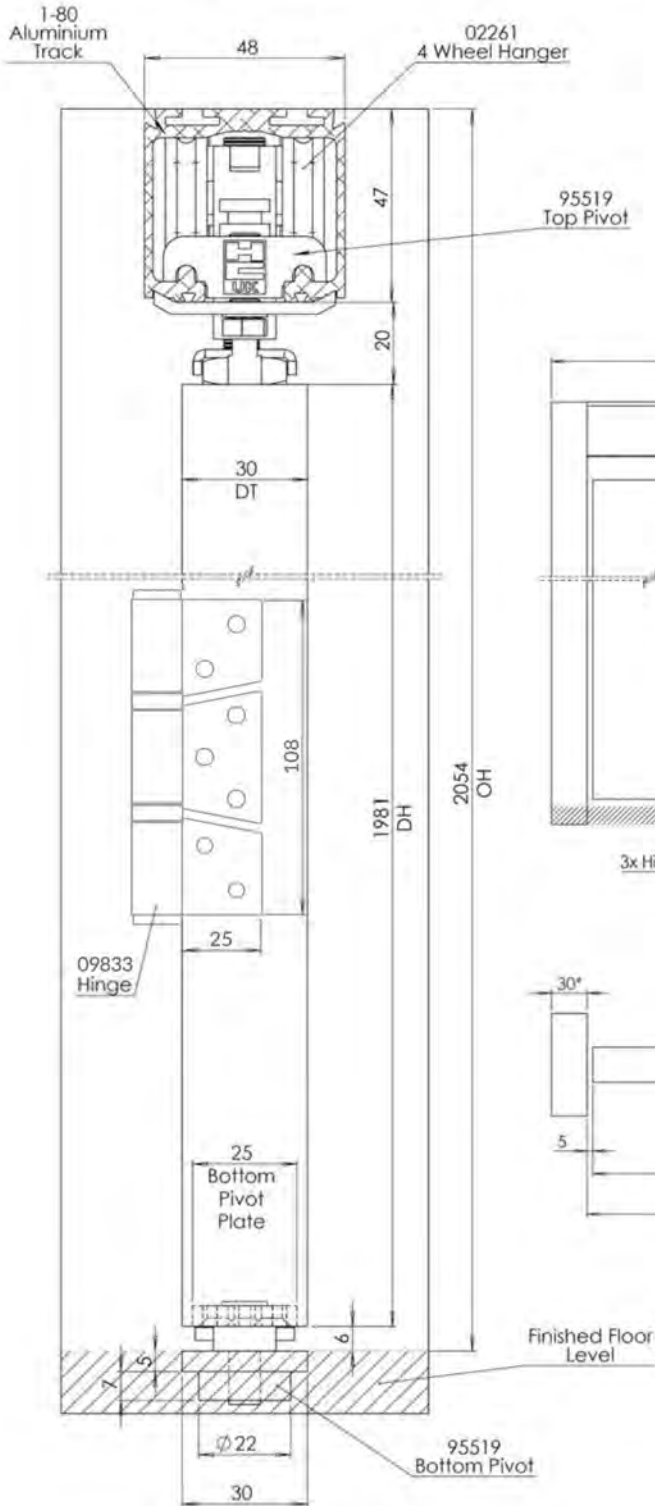

- Maximum door weight 50kg
- DH - Door height, maximum door height 3000mm
- DWi - Door width, maximum 850mm
- DT - Door thickness between 30mm and 50mm
- OW - Opening width
- OH - Opening height
- * - Recommended value

SECTION A-A

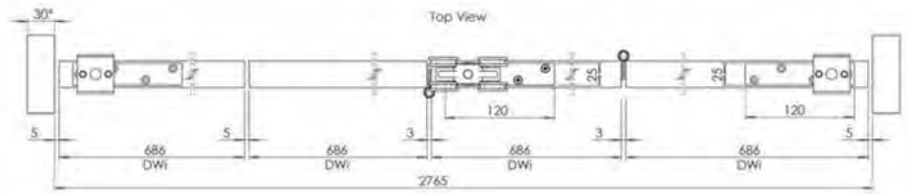
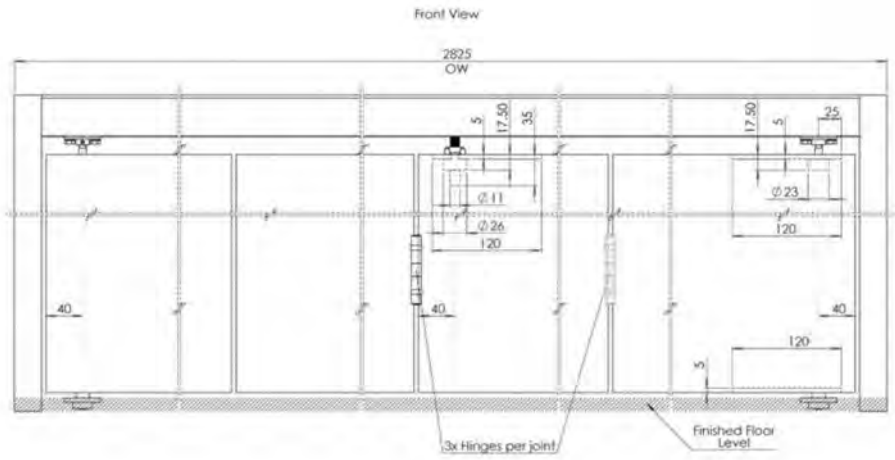
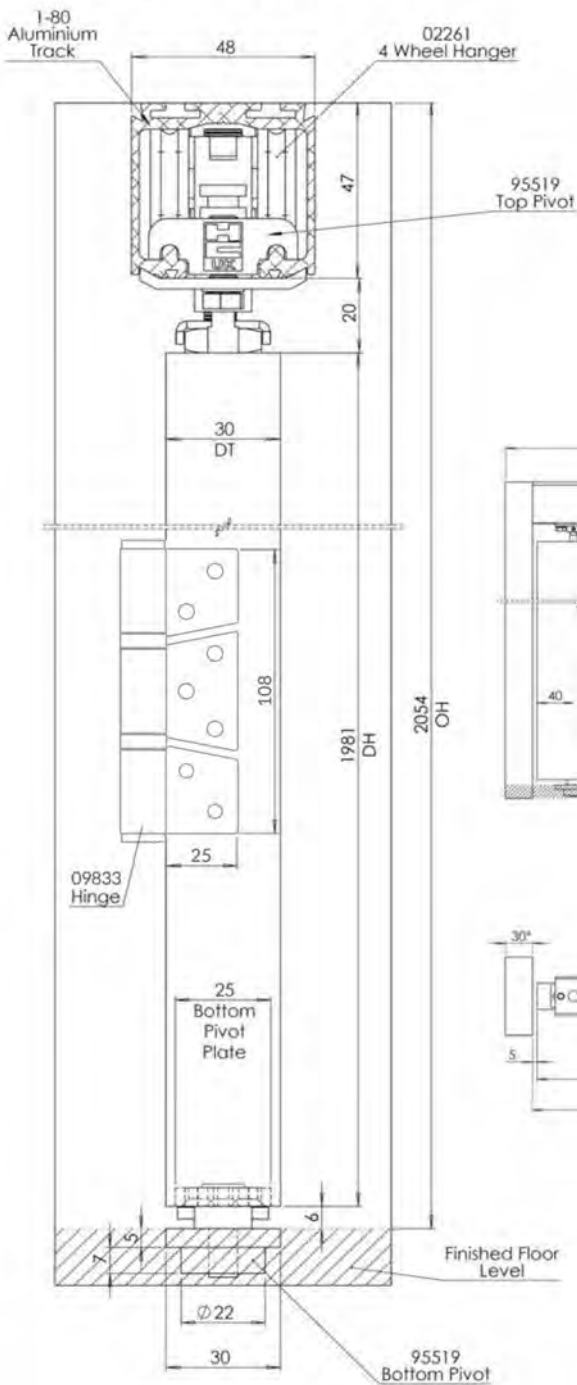

Maximum door weight 50kg
 DH - Door height, maximum door height 3000mm
 DWi - Door width, maximum 850mm
 DT - Door thickness between 30mm and 50mm
 OW - Opening width
 OH - Opening height
 * - Recommended value

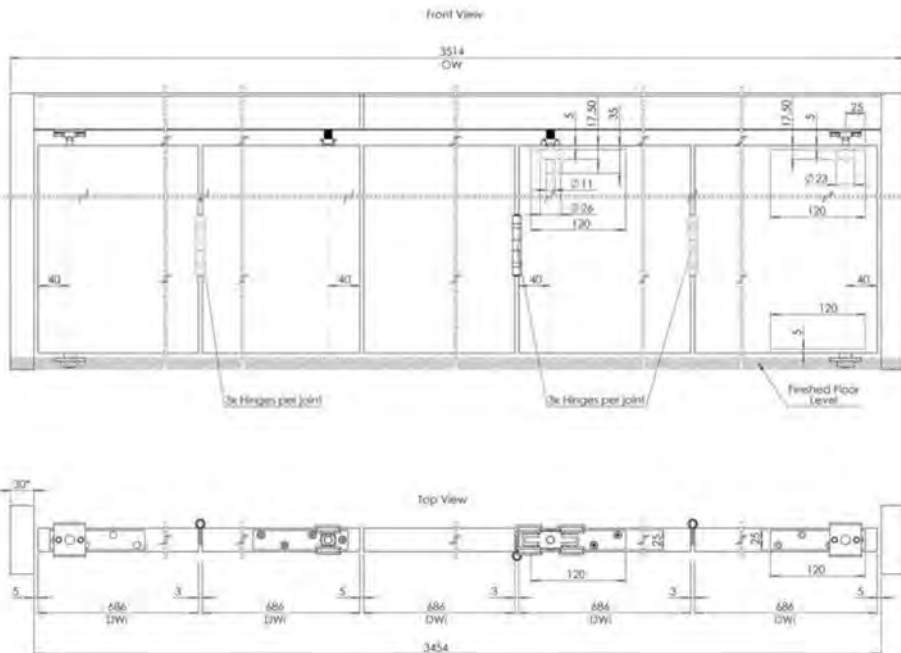
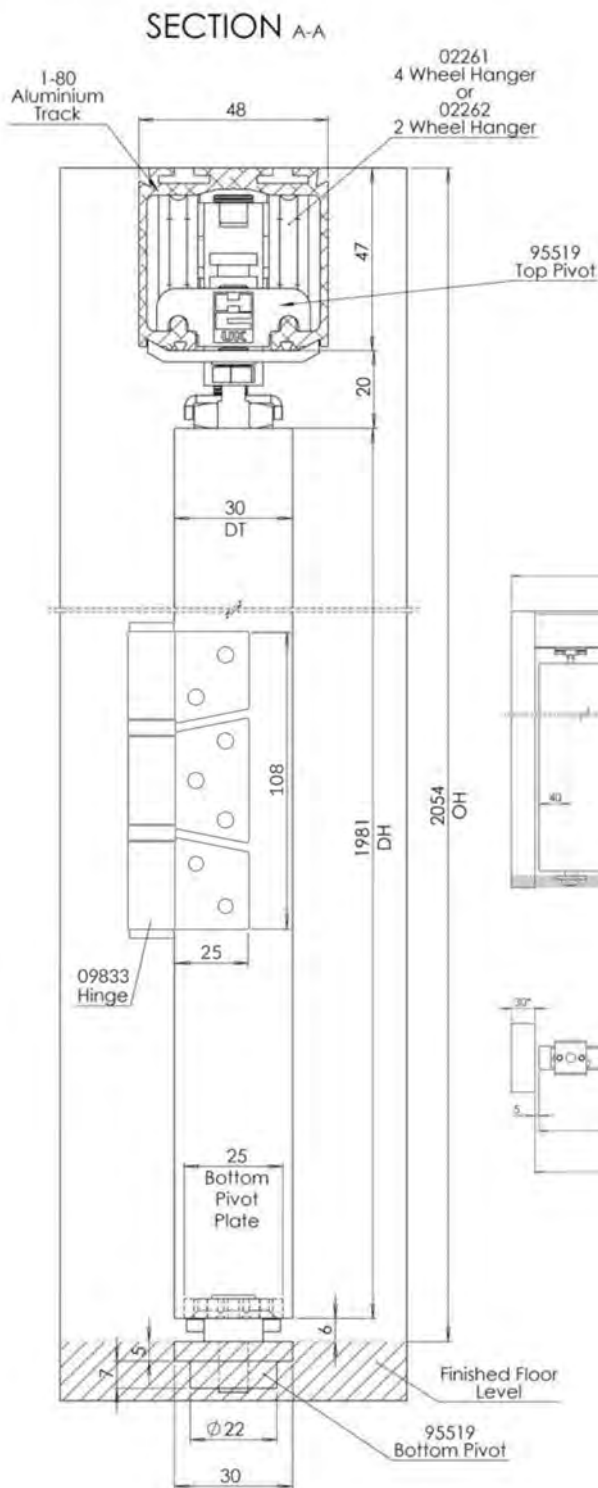

Maximum door weight 50kg
 DH - Door height, maximum door height 3000mm
 DWI - Door width, maximum 850mm
 DT - Door thickness between 30mm and 50mm
 OW - Opening width
 OH - Opening height
 * - Recommended value

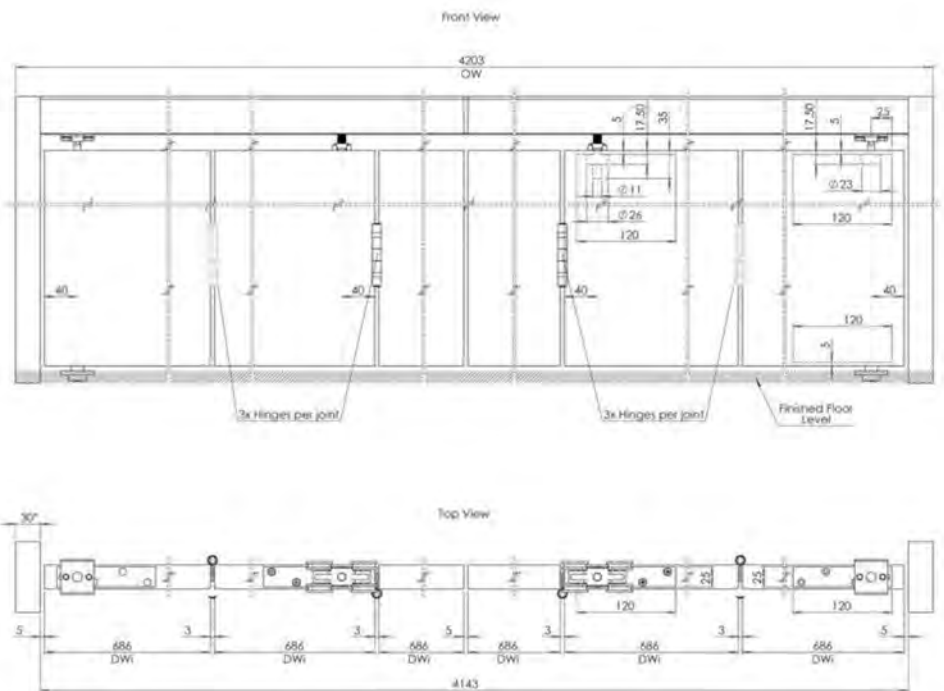
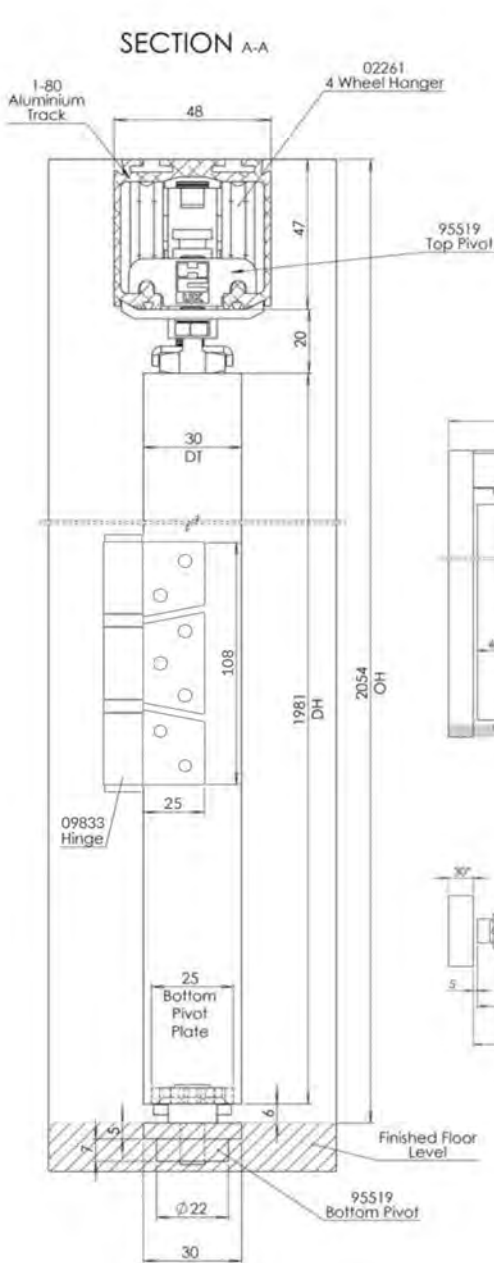

Maximum door weight 50kg
 DH - Door height, maximum door height 3000mm
 DWi - Door width, maximum 850mm
 DT - Door thickness between 30mm and 50mm
 OW - Opening width
 OH - Opening height

SURFACE BOLT SPECIFICATIONS

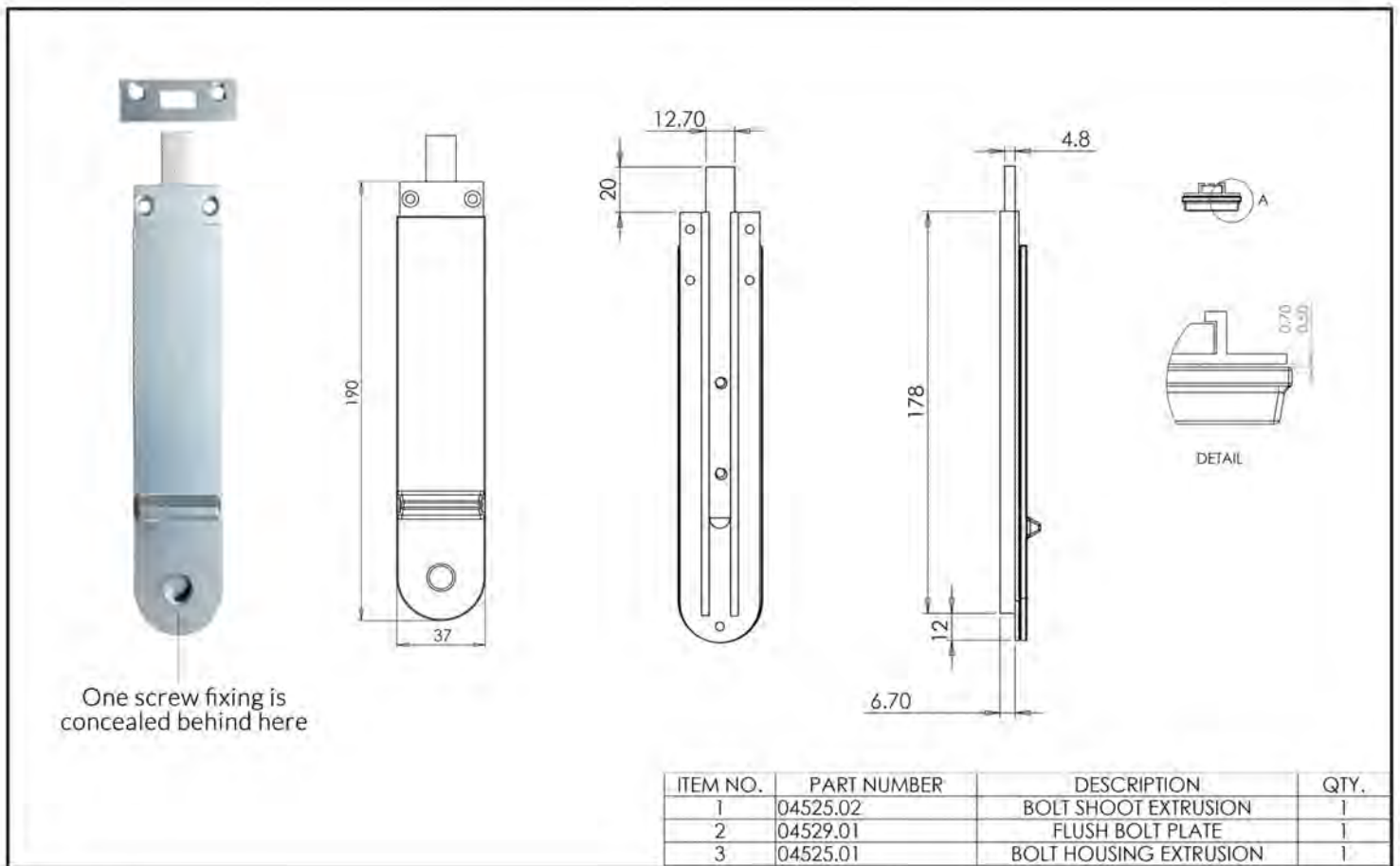

Bolt Positioning:

Bottom of Door Advice (Preferred Method) :

When fitting bolts to the bottom of the door be aware that the floor will need a recess cut to accommodate the bolt keeper, wooden floors are the easiest to recess, other floors depending on floor type may need you to obtain rawl plugs and a decision whether to recess the bolt keeper or fit it on the surface of the floor.

Top of Door Advice:

When fitting bolts to the top of the door be aware that the top channel will need drilling to form a keeper aperture in the top track.

Additionally, using the supplied bolt keeper will require screw holes, any surface fixed keeper screws should then be fitted, removed and the thread cut so that the screws do not project into the track channel when the screws are refitted - leaving the screws at their full length will damage the running gear when in operation.

HINGE HANDLE POSITION

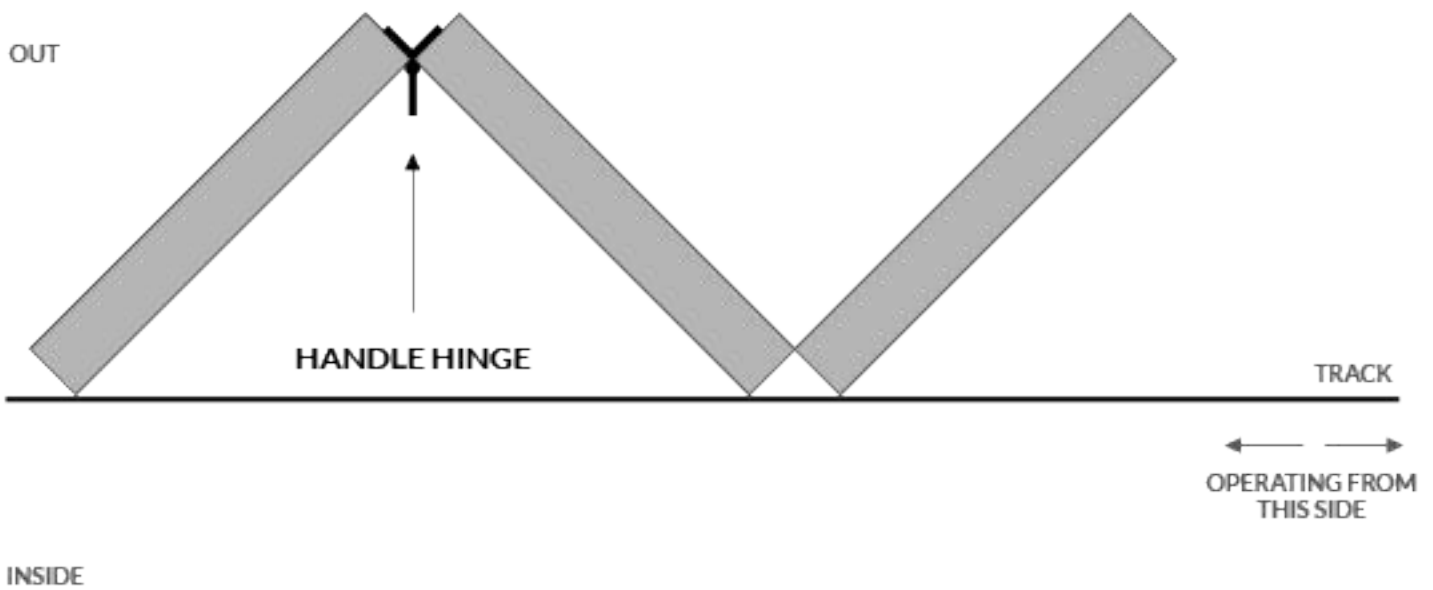
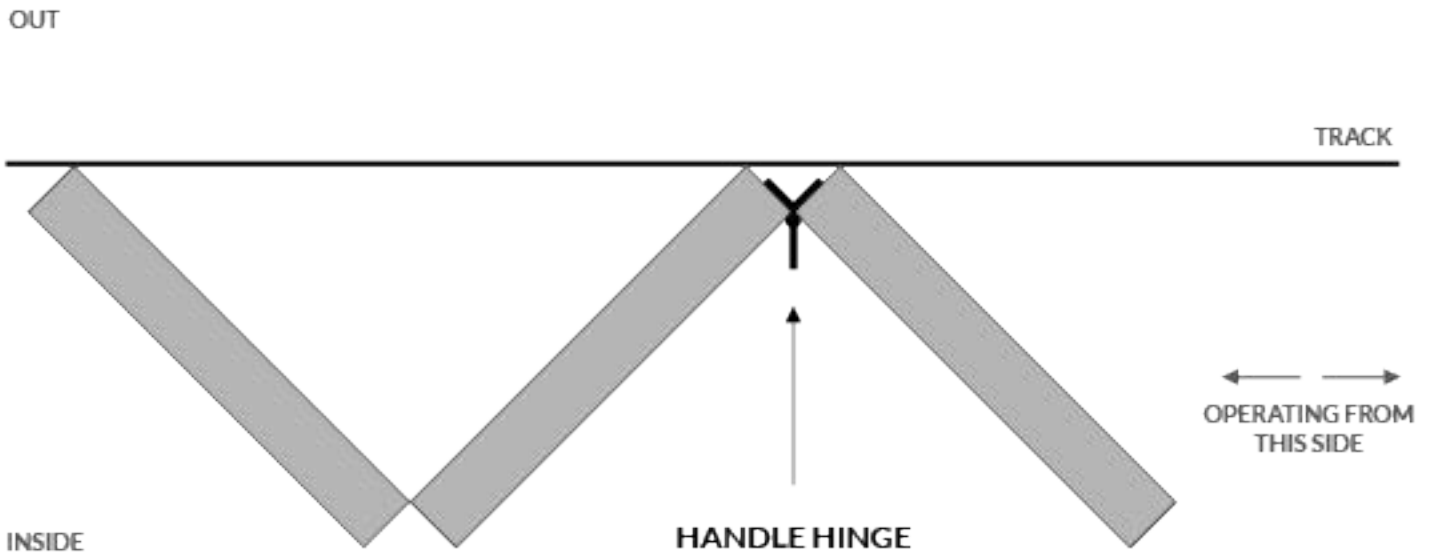

NOTE: Always open the door carefully against the hinge pull handle to avoid door damage.

HOLDBACK CATCH POSITION

HOLDBACK CATCH POSITION

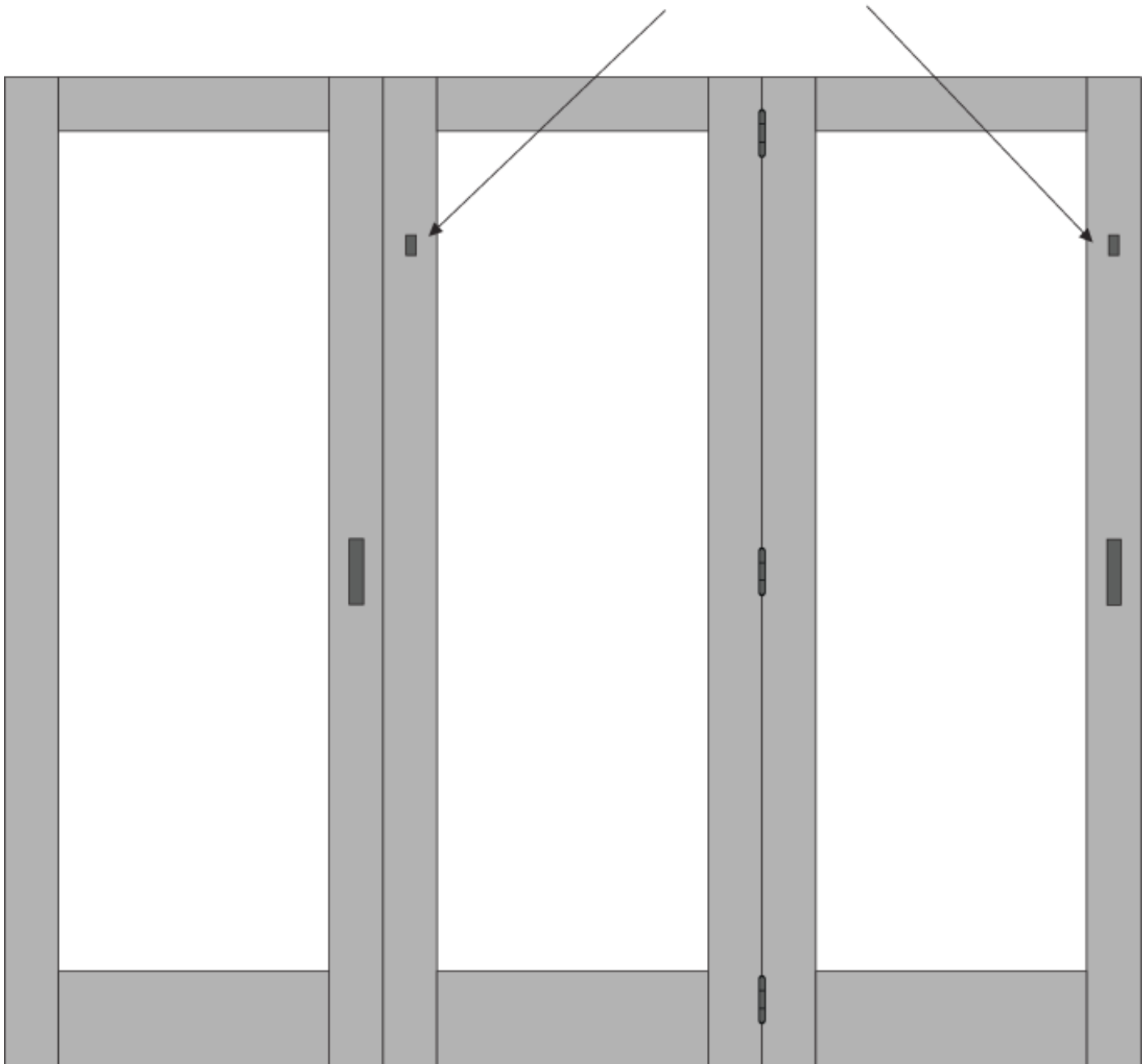

FITTING INSTRUCTIONS

THRUFOLD® Folding Door Systems

COMPONENTS

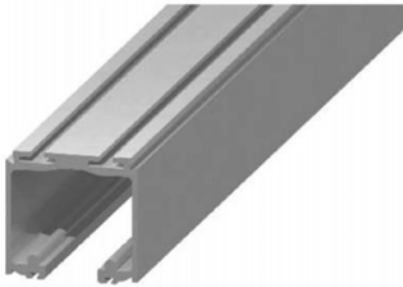

Anodized Aluminium Top Track



Top & Bottom pivot assembly



4 Wheel intermediate hanger set



2 Wheel end hanger set



Typical hinge pack depending on product configuration

Technical Specifications

Maximum door weight: 50kg

Maximum door width: 850mm

Maximum door height: 3000mm

Door Thickness: 30 – 50mm

Track Dimensions:
47mm (w) x 48mm (h)

Foldaside 50

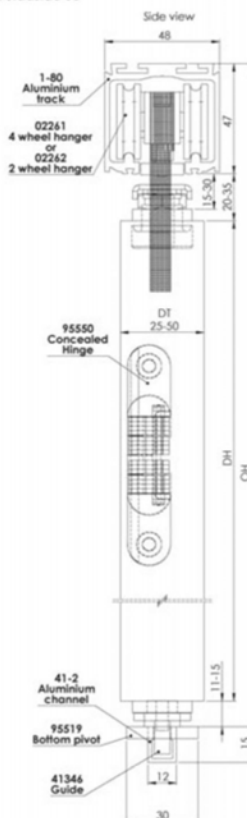

Maximum door weight 50kg
DH - Door height, maximum door height 3000mm
DWI - Door width, maximum 850mm
DT - Door thickness between 25mm and 50mm
OW - Opening width
OH - Opening height

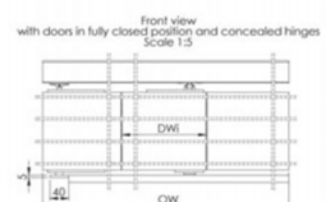
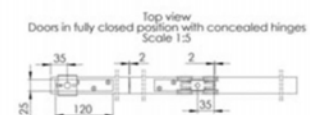
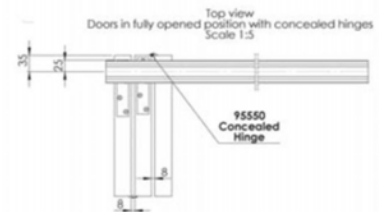
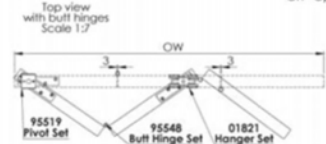

Step 3. Preparing the door and track.

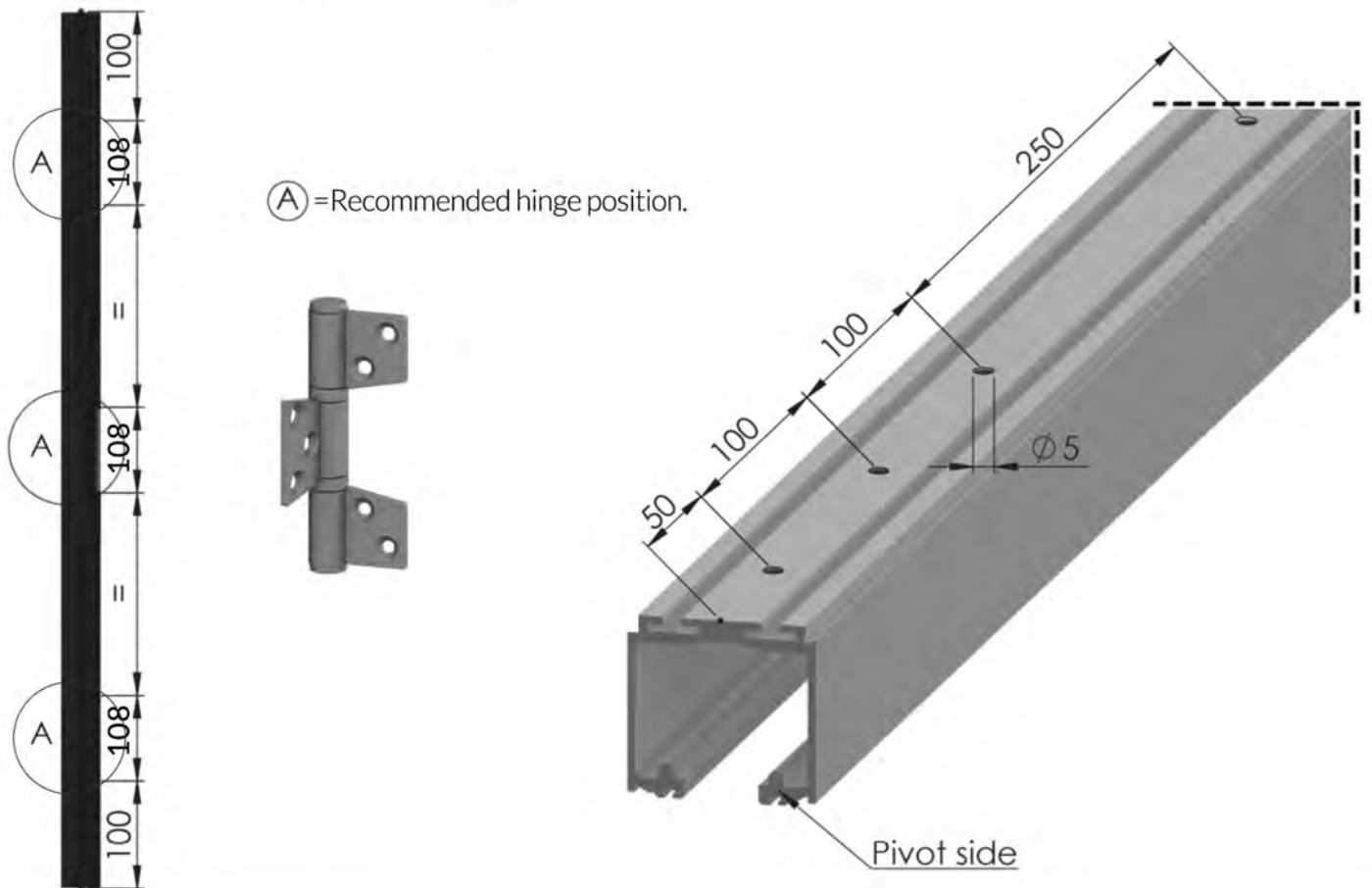

Step 4. Door configuration.

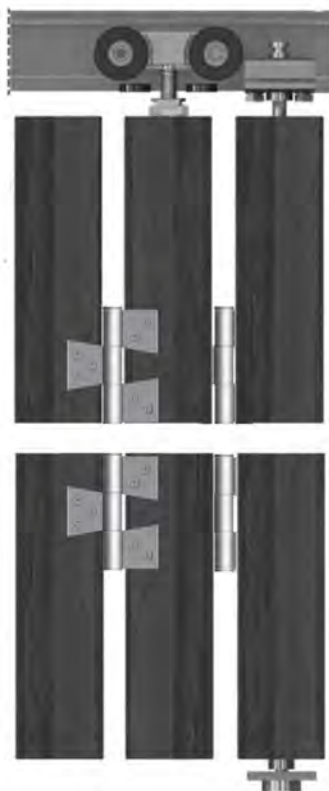

3 Door System

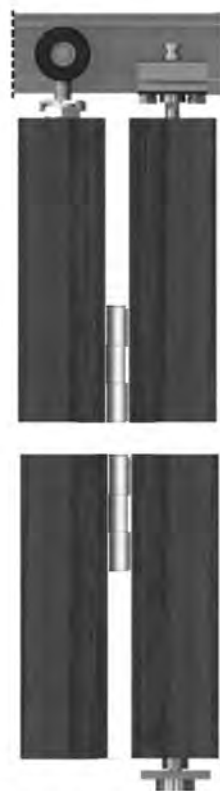

2 Door System



1 Door System

Step 5. Bottom pivot base.

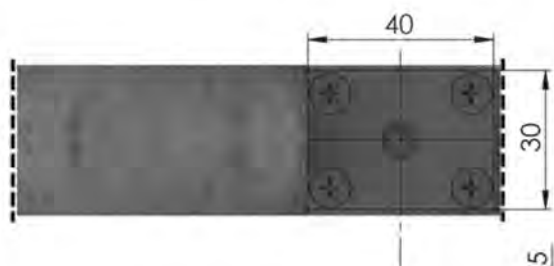

Fix the bottom pivot base plate with 4 screws.



Insert the top pivot into track and raise the top pivot pin so that the door can go under the assembly



Insert the bottom pivot pin in the base plate and release the top pivot pin inside the top plate.

Step 6. Leveling the door and insert the next leaf.



After ensuring the door level, tighten the 2 screws to fix the top pivot(1), afterwards tighten the grub screw to secure the top pivot pin(2)



Insert the top hanger into track and door into bottom pivot.

Bring assembly in position as seen in the left picture, ensure the level by adjusting the hanger bolt (after adjusting put the lock washer in place) and secure with screws.

Follow this step until the desired number of doors is achieved



All content and images are copyright protected by DirectDoors.com