

**art. 0032 filetto GAS****art. 0033 filetto NPT****saracinesca a leva riscaldabile***heatable lever gate valve**vanne à levier réchauffable**heizbarer Hebelschieber**tajadera a leva calentable***Art. 0032 / Item 0032****Filettatura: gas cilindrica UNI EN ISO 228/1**

Thread: BSP parallel UNI EN ISO 228/1

Art. 0033 / Item 0033**Filettatura: conico NPT USAS B 2.1**

Thread: conical NPT USAS B 2.1

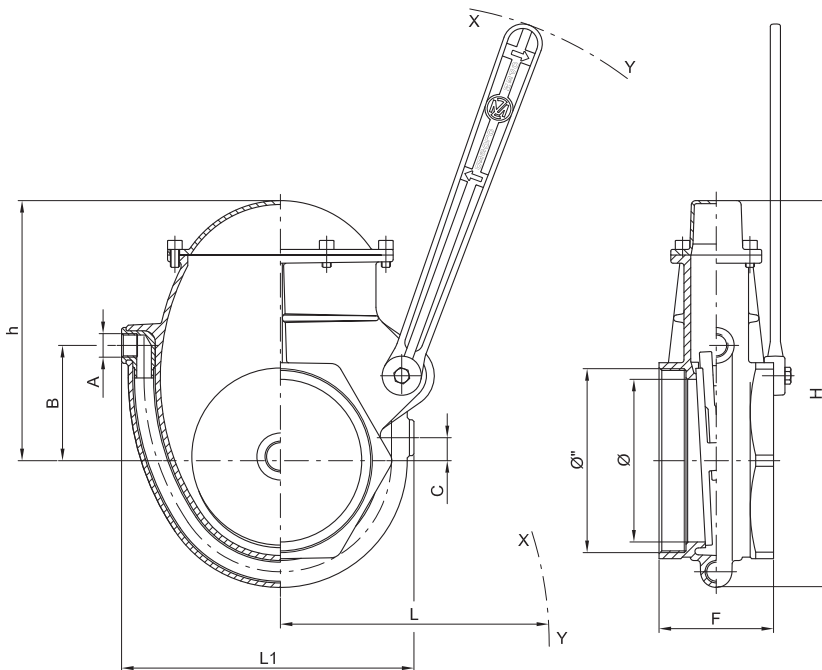

Ø"	4"	6"
Ø	93	145
B	74	100
C	15	27
F	100	102
h	157	232
H	~ 242	~ 347
L max	385	462
gr ~	6.700	12.160

Art. 0032 / Item 0032

A	1/2" GAS	1/2" GAS
L1	234	277

Art. 0033 / Item 0033

A	1/2" NPT	1/2" NPT
L1	274	317

Codici di ordinazione

Purchase article numbers

	Filetto GAS GAS thread	Filetto NPT NPT thread
Saracinesca a leva riscaldabile da 4" Heatable lever gate valve 4"	ARZO 0032 100 000	ARZO 0033 100 000
Saracinesca a leva riscaldabile da 6" Heatable lever gate valve 6"	ARZO 0032 150 000	ARZO 0033 150 000



Condizioni di esercizio

Work conditions

DN	4" - 6"
P (bar)	6
P (PSI)	90
T (°C)	-15 +80

Tabella conversione Ø"(in) - DN (mm)

Ø"(in) - DN (mm) conversion table

Ø"	4"	6"
DN	100	150

POS.	CODICE / CODE	DENOMINAZIONE	DENOMINATION	MATERIALE	MATERIAL
1	FOZO 0032 100 001	CORPO 4" GAS	BODY 4" GAS	OTTONE UNI EN 1982	UNI EN 1982 BRASS
1	FOZO 0032 150 001	CORPO 6" GAS	BODY 6" GAS	OTTONE UNI EN 1982	UNI EN 1982 BRASS
1	FOZO 0033 100 001	CORPO 4" NPT	BODY 4" NPT	OTTONE UNI EN 1982	UNI EN 1982 BRASS
1	FOZO 0033 150 001	CORPO 6" NPT	BODY 6" NPT	OTTONE UNI EN 1982	UNI EN 1982 BRASS
2	VTAC 0030 100 008	VITE TE M8x16	SCREW TE M8x16	ACCIAIO INOX AISI 304	AISI 304 STAINLESS STEEL
3	FOZO 0030 100 012	MANIGLIA 4"	HANDLE 4"	OTTONE UNI EN 1982	UNI EN 1982 BRASS
3	FOZO 0030 150 012	MANIGLIA 6"	HANDLE 6"	OTTONE UNI EN 1982	UNI EN 1982 BRASS
4	TOZO 0030 100 007	PREMISTOPPA Ø35 f19	NUT Ø35 f19	OTTONE UNI EN 12164	UNI EN 12164 BRASS
5	SPZO 0030 100 006	GUARNIZIONE Ø32 x 22 x 8	GASKET Ø32 x 22 x 8	POLIMERO	POLYMER
6	TOZO 0030 100 010	PERNO 4"	PIN 4"	OTTONE UNI EN 12164	UNI EN 12164 BRASS
6	TAZO 0030 150 10A	PERNO 6"	PIN 6"	ACCIAIO INOX AISI 304	AISI 304 STAINLESS STEEL
7a	SOZO 0030 100 02A	DISCO MASCHIO 4"	MAL DISC 4"	OTTONE UNI EN 12165	UNI EN 12165 BRASS
7a	SOZO 0030 150 02A	DISCO MASCHIO 6"	MAL DISC 6"	OTTONE UNI EN 12165	UNI EN 12165 BRASS
7b	SOZO 0030 100 02B	DISCO FEMMINA 4"	FEMALE DISC 4"	OTTONE UNI EN 12165	UNI EN 12165 BRASS
7b	SOZO 0030 150 02B	DISCO FEMMINA 6"	FEMALE DISC 6"	OTTONE UNI EN 12165	UNI EN 12165 BRASS
8	SOZO 0030 100 003	LEVA INTERNA 4"	INNER LEVER 4"	OTTONE UNI EN 1982	UNI EN 1982 BRASS
8	SOZO 0030 150 003	LEVA INTERNA 6"	INNER LEVER 6"	OTTONE UNI EN 1982	UNI EN 1982 BRASS
9	GGUA 0030 100 004	GUARNIZIONE 4"	GASKET 4"	GUAMOTOR	GUAMOTOR
9	GGUA 0030 150 004	GUARNIZIONE 6"	GASKET 6"	GUAMOTOR	GUAMOTOR
10	SOZO 0030 100 005	TESTATA 4"	HEAD 4"	OTTONE UNI EN 1982	UNI EN 1982 BRASS
10	FOZO 0030 150 005	TESTATA 6"	HEAD 6"	OTTONE UNI EN 12165	UNI EN 12165 BRASS
11	VTAC 0020 100 009	VITE TCEI M8x16	SCREW TCEI M8x16	ACCIAIO INOX AISI 304	AISI 304 STAINLESS STEEL