



# art. 0072 filetto GAS

# art. 0073 filetto NPT

## saracinesca a stantuffo a 1 flangia

stem gate valve with 1 flange  
vanne à piston avec 1 bride  
Kolbenschieber mit 1 Flansch  
tajadera c/ pistón con una brida



**Art. 0072 / Item 0072**  
**Filettatura: gas cilindrica UNI EN ISO 228/1**  
 Thread: BSP parallel UNI EN ISO 228/1

**Art. 0073 / Item 0073**  
**Filettatura: conico NPT USAS B 2.1**  
 Thread: conical NPT USAS B 2.1

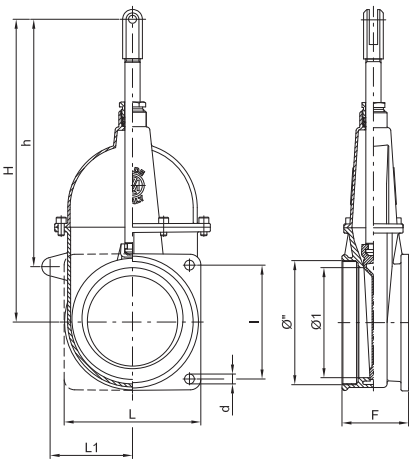

Ø"	Codice / Code	Ø1	h	H	L	L1	d	l	F	gr
4"	ARZO 0072 100 000	95	258	313	180	75,5	13	150	80	5.060
5"	ARZO 0072 125 000	120	292	347	180	91	13	150	81	6.020
6"	ARZO 0072 150 000	145	327	400	180	107,5	13	150	87	7.710
4"	ARZO 0073 100 000	95	258	313	180	75,5	13	150	80	5.060
5"	ARZO 0073 125 000	120	292	347	180	91	13	150	81	6.020
6"	ARZO 0073 150 000	145	327	400	180	107,5	13	150	87	7.710

Senza asta / Without stem

Ø"	Codice / Code	gr
4"	ARZO 0072 100 SMO	4.390
5"	ARZO 0072 125 SMO	4.980
6"	ARZO 0072 150 SMO	6.690
4"	ARZO 0073 100 SMO	4.390
5"	ARZO 0073 125 SMO	4.980
6"	ARZO 0073 150 SMO	6.690



Con cilindro art. 0500 / With cylinder item 0500

Ø"	Codice / Code	h	H	gr
4"	ARZO 0072 100 500	243	677	7.980
5"	ARZO 0072 125 500	288	722	8.610
6"	ARZO 0072 150 500	323	757	10.350
4"	ARZO 0073 100 500	243	677	7.980
5"	ARZO 0073 125 500	288	722	8.610
6"	ARZO 0073 150 500	323	757	10.350

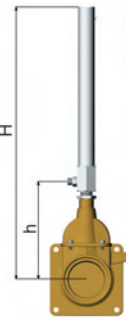

Con cilindro art. 0510 / With cylinder item 0510

Ø"	Codice / Code	h	H	gr
4"	ARZO 0072 100 510	243	631	11.070
5"	ARZO 0072 125 510	288	676	11.660
6"	ARZO 0072 150 510	323	711	13.510
4"	ARZO 0073 100 510	243	631	11.070
5"	ARZO 0073 125 510	288	676	11.660
6"	ARZO 0073 150 510	323	711	13.510

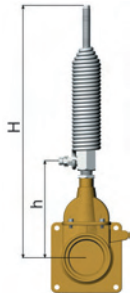

Con cilindro art. 0550 / With cylinder item 0550

Ø"	Codice / Code	h	H	gr
4"	ARZO 0072 100 550	243	493	6.550
5"	ARZO 0072 125 550	288	538	7.140
6"	ARZO 0072 150 550	323	573	8.850
4"	ARZO 0073 100 550	243	493	6.550
5"	ARZO 0073 125 550	288	538	7.140
6"	ARZO 0073 150 550	323	573	8.850

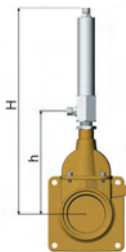

Con cilindro art. 0570 / With cylinder item 0570

Ø"	Codice / Code	h	H	gr
4"	ARZO 0072 100 570	246	444	7.360
5"	ARZO 0072 125 570	291	513	8.100
6"	ARZO 0072 150 570	326	575	9.980
4"	ARZO 0073 100 570	246	444	7.360
5"	ARZO 0073 125 570	291	513	8.100
6"	ARZO 0073 150 570	326	575	9.980

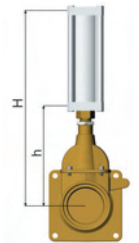

Con cilindro art. 0571 / With cylinder item 0571

Ø"	Codice / Code	h	H	gr
4"	ARZO 0072 100 571	246	444	7.390
5"	ARZO 0072 125 571	291	513	8.130
6"	ARZO 0072 150 571	326	575	10.010
4"	ARZO 0073 100 571	246	444	7.390
5"	ARZO 0073 125 571	291	513	8.130
6"	ARZO 0073 150 571	326	575	10.010

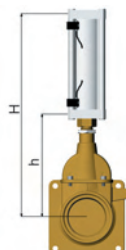

Con cilindro art. 0580 / With cylinder item 0580

Ø"	Codice / Code	h	H	gr
4"	ARZO 0072 100 580	245	533	12.190
6"	ARZO 0072 150 580	325	728	16.460
4"	ARZO 0073 100 580	245	533	12.190
6"	ARZO 0073 150 580	325	728	16.460

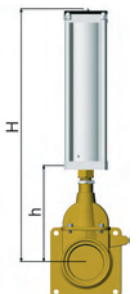



Condizioni di esercizio

Work conditions

DN	4" - 5"	6"
P(Bar)	3	2,5
P(PSI)	45	35
T °C	-15 +80	

POS.	CODICE / CODE	DENOMINAZIONE	DENOMINATION	MATERIALE	MATERIAL
1	FOZO 0072 100 001	CORPO 4" GAS	BODY 4" GAS	OTTONE UNI EN 1982	UNI EN 1982 BRASS
1	FOZO 0072 125 001	CORPO 5" GAS	BODY 5" GAS	OTTONE UNI EN 1982	UNI EN 1982 BRASS
1	FOZO 0072 150 001	CORPO 6" GAS	BODY 6" GAS	OTTONE UNI EN 1982	UNI EN 1982 BRASS
1	FOZO 0073 100 001	CORPO 4" NPT	BODY 4" NPT	OTTONE UNI EN 1982	UNI EN 1982 BRASS
1	FOZO 0073 125 001	CORPO 5" NPT	BODY 5" NPT	OTTONE UNI EN 1982	UNI EN 1982 BRASS
1	FOZO 0073 150 001	CORPO 6" NPT	BODY 6" NPT	OTTONE UNI EN 1982	UNI EN 1982 BRASS
2	GGUA 0070 100 004	GUARNIZIONE 4"	GASKET 4"	GUAMOTOR	GUAMOTOR
2	GGUA 0070 125 004	GUARNIZIONE 5"	GASKET 5"	GUAMOTOR	GUAMOTOR
2	GGUA 0070 150 004	GUARNIZIONE 6"	GASKET 6"	GUAMOTOR	GUAMOTOR
3	FOZO 0070 100 002	CUNEO 4"	GATE 4"	OTTONE UNI EN 1982	UNI EN 1982 BRASS
3	FOZO 0070 125 002	CUNEO 5"	GATE 5"	OTTONE UNI EN 1982	UNI EN 1982 BRASS
3	FOZO 0070 150 002	CUNEO 6"	GATE 6"	OTTONE UNI EN 1982	UNI EN 1982 BRASS
4	SAZO 0040 100 011	FASCETTA DI BLOCCAGGIO Ø20	LOCKING CLAMP Ø20	ACCIAIO INOX AISI 304	AISI 304 STAINLESS STEEL
5	TOZO 0040 100 003	ASTA 4"	STEM 4"	OTTONE UNI EN 12164	UNI EN 12164 BRASS
5	TOZO 0070 125 003	ASTA 5"	STEM 5"	OTTONE UNI EN 12164	UNI EN 12164 BRASS
5	TOZO 0040 150 003	ASTA 6"	STEM 6"	OTTONE UNI EN 12164	UNI EN 12164 BRASS
6	FOZO 0070 100 005	TESTATA 4"	HEAD 4"	OTTONE UNI EN 1982	UNI EN 1982 BRASS
6	FOZO 0070 125 005	TESTATA 5"	HEAD 5"	OTTONE UNI EN 1982	UNI EN 1982 BRASS
6	FOZO 0070 150 005	TESTATA 6"	HEAD 6"	OTTONE UNI EN 1982	UNI EN 1982 BRASS
7	VTAC 0020 100 009	VITE TCEI M8x16	SCREW TCEI M8x16	ACCIAIO INOX AISI 304	AISI 304 STAINLESS STEEL
8	SPZO 0040 100 006	GUARNIZIONE Ø27 x 20 x 8	GASKET Ø27 x 20 x 8	POLIMERO	POLYMER
9	TOZO 0040 100 007	PREMISTOPPA M30x2	NUT M30x2	OTTONE UNI EN 12164	UNI EN 12164 BRASS
10	FOZO 0040 100 008	FORCELLA	FORK	OTTONE UNI EN 1982	UNI EN 1982 BRASS
11	..OR 0020 100 010	OR 225 (Øi 159,5 x 6,99)	O RING 225 (Øi 159,5 x 6,99)	GOMMA NBR 70	NBR 70 RUBBER