

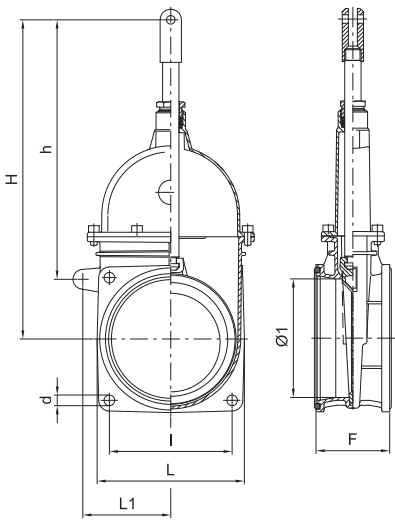

# art. 0075

saracinesca a stantuffo a 2 flange  
stem gate valve with 2 flanges  
vanne à piston avec 2 brides  
Kolbenschieber mit 2 Flanschen  
tajadera c/ pistón con doble brida



Ø"	Codice / Code	Ø1	h	H	L	L1	d	I	F	gr
6"	ARZO 0075 150 000	145	324	400	180	107,5	13	150	90	7.150

Senza asta / Without stem

Ø"	Codice / Code	gr
6"	ARZO 0075 150 SMO	6.200

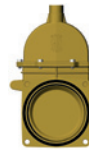

Con cilindro art. 0500 / With cylinder item 0500

Ø"	Codice / Code	h	H	gr
6"	ARZO 0075 150 500	323	757	9.790

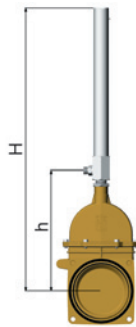

Con cilindro art. 0510 / With cylinder item 0510

Ø"	Codice / Code	h	H	gr
6"	ARZO 0075 150 510	323	711	13.020

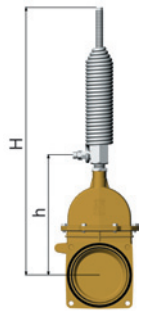

Con cilindro art. 0550 / With cylinder item 0550

Ø"	Codice / Code	h	H	gr
6"	ARZO 0075 150 550	323	573	8.360

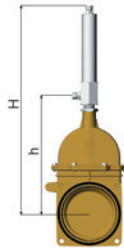

Con cilindro art. 0570 / With cylinder item 0570

Ø"	Codice / Code	h	H	gr
6"	ARZO 0075 150 570	326	575	9.490

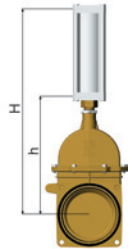

Con cilindro art. 0571 / With cylinder item 0571

Ø"	Codice / Code	h	H	gr
6"	ARZO 0075 150 571	326	575	9.520

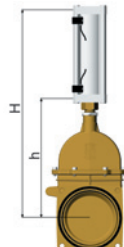

Con cilindro art. 0580 / With cylinder item 0580

Ø"	Codice / Code	h	H	gr
6"	ARZO 0075 150 580	325	728	15.970

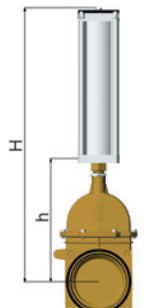

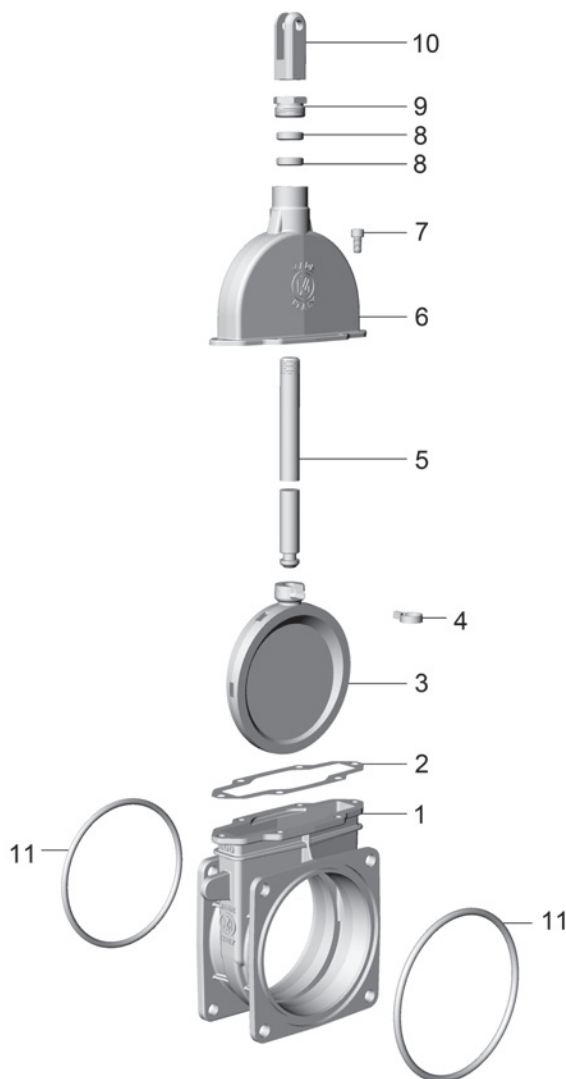

Condizioni di esercizio

Work conditions

DN	6"
P(Bar)	2,5
P(PSI)	35
T °C	-15 +80

POS.	CODICE / CODE	DENOMINAZIONE	DENOMINATION	MATERIALE	MATERIAL
1	FOZO 0075 150 001	CORPO 6"	BODY 6"	OTTONE UNI EN 1982	UNI EN 1982 BRASS
2	GGUA 0075 150 004	GUARNIZIONE 6"	GASKET 6"	GUAMOTOR	GUAMOTOR
3	FOZO 0070 150 002	CUNEO 6"	GATE 6"	OTTONE UNI EN 1982	UNI EN 1982 BRASS
4	SAZO 0040 100 011	FASCETTA DI BLOCCAGGIO Ø20	LOCKING CLAMP Ø20	ACCIAIO INOX AISI 304	AISI 304 STAINLESS STEEL
5	TOZO 0040 150 003	ASTA 6"	STEM 6"	OTTONE UNI EN 12164	UNI EN 12164 BRASS
6	FOZO 0075 150 005	TESTATA 6"	HEAD 6"	OTTONE UNI EN 1982	UNI EN 1982 BRASS
7	VTAC 0020 100 009	VITE TCEI M8×16	SCREW TCEI M8×16	ACCIAIO INOX AISI 304	AISI 304 STAINLESS STEEL
8	SPZO 0040 100 006	GUARNIZIONE Ø27 × 20 × 8	GASKET Ø27 × 20 × 8	POLIMERO	POLYMER
9	TOZO 0040 100 007	PREMISTOPPA M30×2	NUT M30×2	OTTONE UNI EN 12164	UNI EN 12164 BRASS
10	FOZO 0040 100 008	FORCELLA	FORK	OTTONE UNI EN 1982	UNI EN 1982 BRASS
11	..OR 0020 100 010	OR 225 (Øi 159,5 × 6,99)	O RING 225 (Øi 159,5 × 6,99)	GOMMA NBR 70	NBR 70 RUBBER