

**art. 0040 filetto GAS**
art. 0041 filetto NPT**saracinesca a stantuffo***stem gate valve**vanne à piston**Kolbenschieber**tajadera c/ pistón***Art. 0040 / Item 0040****Filettatura: gas cilindrica UNI EN ISO 228/1**

Thread: BSP parallel UNI EN ISO 228/1

Art. 0041 / Item 0041**Filettatura: conico NPT USAS B 2.1**

Thread: conical NPT USAS B 2.1

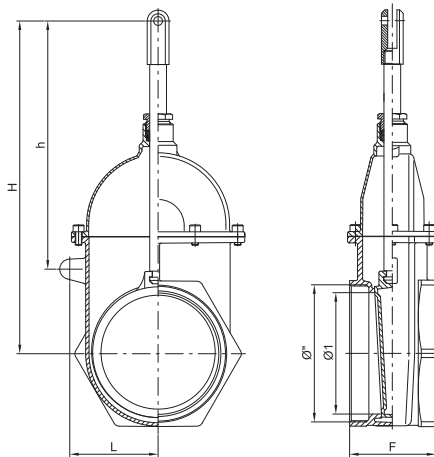

Ø"	Codice / Code	Ø1	h	H	L	F	📦 gr
4"	ARZO 0040 100 000	95	234	308	100,5	90	4.950
6"	ARZO 0040 150 000	145	286	390	105,5	102	9.190
4"	ARZO 0041 100 000	95	234	308	100,5	90	4.950
6"	ARZO 0041 150 000	145	286	390	105,5	102	9.190

Senza asta / Without stem

Ø"	Codice / Code	📦 gr
4"	ARZO 0040 100 SMO	4.200
6"	ARZO 0040 150 SMO	8.200
4"	ARZO 0041 100 SMO	4.200
6"	ARZO 0041 150 SMO	8.200

**Con cilindro art. 0500 / With cylinder item 0500**

Ø"	Codice / Code	h	H	📦 gr
4"	ARZO 0040 100 500	239	673	7.790
6"	ARZO 0040 150 500	318	752	11.860
4"	ARZO 0041 100 500	239	673	7.790
6"	ARZO 0041 150 500	318	752	11.860

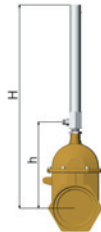
**Con cilindro art. 0510 / With cylinder item 0510**

Ø"	Codice / Code	h	H	📦 gr
4"	ARZO 0040 100 510	239	627	10.880
6"	ARZO 0040 150 510	318	706	15.020
4"	ARZO 0041 100 510	239	627	10.880
6"	ARZO 0041 150 510	318	706	15.020

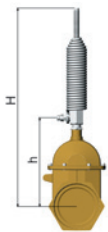
**Con cilindro art. 0550 / With cylinder item 0550**

Ø"	Codice / Code	h	H	📦 gr
4"	ARZO 0040 100 550	239	489	6.360
6"	ARZO 0040 150 550	318	568	10.360
4"	ARZO 0041 100 550	239	489	6.360
6"	ARZO 0041 150 550	318	568	10.360

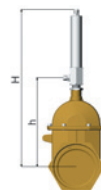
**Con cilindro art. 0570 / With cylinder item 0570**

Ø"	Codice / Code	h	H	📦 gr
4"	ARZO 0040 100 570	242	440	7.170
6"	ARZO 0040 150 570	321	570	11.920
4"	ARZO 0041 100 570	242	440	7.170
6"	ARZO 0041 150 570	321	570	11.920

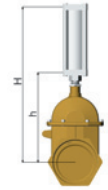
**Con cilindro art. 0571 / With cylinder item 0571**

Ø"	Codice / Code	h	H	📦 gr
4"	ARZO 0040 100 571	242	440	7.200
6"	ARZO 0040 150 571	321	570	11.950
4"	ARZO 0041 100 571	242	440	7.200
6"	ARZO 0041 150 571	321	570	11.950

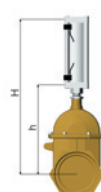
**Con cilindro art. 0580 / With cylinder item 0580**

Ø"	Codice / Code	h	H	📦 gr
4"	ARZO 0040 100 580	241	529	12.000
6"	ARZO 0040 150 580	320	723	17.970
4"	ARZO 0041 100 580	241	529	12.000
6"	ARZO 0041 150 580	320	723	17.970

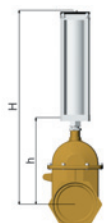

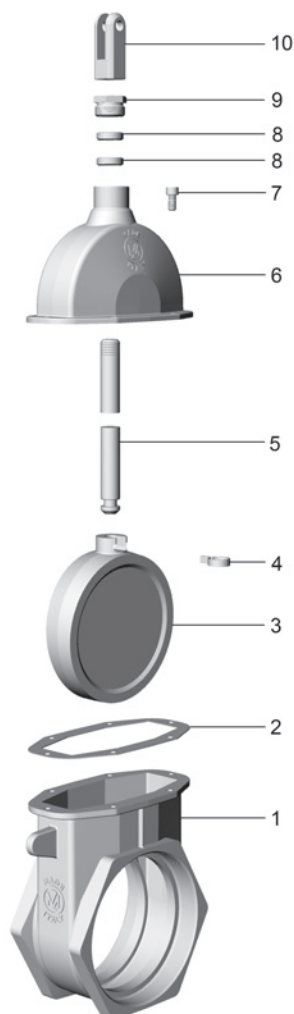

Condizioni di esercizio

Work conditions

DN	4" - 6"
P(Bar)	4
P(PSI)	60
T °C	-15 +80

POS.	CODICE / CODE	DENOMINAZIONE	DENOMINATION	MATERIALE	MATERIAL
1	FOZO 0040 100 001	CORPO 4" GAS	BODY 4" GAS	OTTONE UNI EN 1982	UNI EN 1982 BRASS
1	FOZO 0040 150 001	CORPO 6" GAS	BODY 6" GAS	OTTONE UNI EN 1982	UNI EN 1982 BRASS
1	FOZO 0041 100 001	CORPO 4" NPT	BODY 4" NPT	OTTONE UNI EN 1982	UNI EN 1982 BRASS
1	FOZO 0041 150 001	CORPO 6" NPT	BODY 6" NPT	OTTONE UNI EN 1982	UNI EN 1982 BRASS
2	GGUA 0040 100 004	GUARNIZIONE 4"	GASKET 4"	GUAMOTOR	GUAMOTOR
2	GGUA 0040 150 004	GUARNIZIONE 6"	GASKET 6"	GUAMOTOR	GUAMOTOR
3	FOZO 0040 100 002	CUNEO 4"	GATE 4"	OTTONE UNI EN 1982	UNI EN 1982 BRASS
3	FOZO 0040 150 002	CUNEO 6"	GATE 6"	OTTONE UNI EN 1982	UNI EN 1982 BRASS
4	SAZO 0040 100 011	FASCETTA DI BLOCCAGGIO Ø20	LOCKING CLAMP Ø20	ACCIAIO INOX AISI 304	AISI 304 STAINLESS STEEL
5	TOZO 0040 100 003	ASTA 4"	STEM 4"	OTTONE UNI EN 12164	UNI EN 12164 BRASS
5	TOZO 0040 150 003	ASTA 6"	STEM 6"	OTTONE UNI EN 12164	UNI EN 12164 BRASS
6	FOZO 0040 100 005	TESTATA 4"	HEAD 4"	OTTONE UNI EN 1982	UNI EN 1982 BRASS
6	FOZO 0040 150 005	TESTATA 6"	HEAD 6"	OTTONE UNI EN 1982	UNI EN 1982 BRASS
7	VTAC 0020 100 009	VITE TCEI M8×16	SCREW TCEI M8×16	ACCIAIO INOX AISI 304	AISI 304 STAINLESS STEEL
8	SPZO 0040 100 006	GUARNIZIONE Ø27 × 20 × 8	GASKET Ø27 × 20 × 8	POLIMERO	POLYMER
9	TOZO 0040 100 007	PREMISTOPPA M30×2	NUT M30×2	OTTONE UNI EN 12164	UNI EN 12164 BRASS
10	FOZO 0040 100 008	FORCELLA	FORK	OTTONE UNI EN 1982	UNI EN 1982 BRASS