

Thank-you for choosing the Vandersteen Model 3A loudspeaker system. With proper care, your new speakers will provide many years of trouble free, high-quality sonic enjoyment.

The Model 3A is a high-technology product; we recommend that you carefully read this entire manual prior to connecting or using your new loudspeakers.

*Vandersteen Audio*

The Vandersteen Audio Model 3A is a floor standing dynamic loudspeaker developed and refined by almost twenty years of advanced research into loudspeaker design. Engineering, construction, and materials far exceeding industry standards have resulted in a reference quality level of performance unmatched even by larger and more costly designs.

The Model 3A is a worthy addition to any high quality music or audio/video system. The innovative first order crossover supports either bi-wire or vertical bi-amp connection. Superb dynamic and transient

response guarantees superior performance from records, CDs, video tapes, and laser discs. Custom engineered drivers, built exclusively for Vandersteen Audio, are aligned in a boxless design to maximize each driver's accuracy and musicality. An aesthetically pleasing appearance, incorporating an acoustically transparent grille and an audibly vented top, allows the Model 3A to compliment the decor of your home.

The Vandersteen Audio Model 3A is designed and built in the United States of America.

## Contents

<b>Connections</b>	<b>2</b>	Contour Controls	11
Overview	2	<b>Specifications</b>	11
Bi-Wire	3	<b>Associated Equipment</b>	12
Vertical Bi-Amp	4	Amplifier Requirements	12
Mono-Wire	5	Components	12
<b>Speaker Set-Up</b>	<b>6</b>	Cables	12
Listening Height	6	A/V Considerations	13
<b>Speaker Placement</b>	<b>7</b>	<b>Model Three Care</b>	<b>13</b>
Odd Dimensions	7	Maintenance	13
Third Dimensions	9	Service	13
Acoustical Center	9	Support	13
Toe-In	9	<b>Packing Instructions</b>	<b>14</b>
Acoustic Treatments	10	<b>Warranty Information</b>	<b>15</b>
Placement Hints	10		

# MODEL 3A SIGNATURE LOUDSPEAKER OPERATION MANUAL

**The Model 3A contains protection circuits that track voice coil temperatures and reduce the current from your amplifier to one or more of the drivers if excessive temperatures are detected. When these devices are activated, the sound of the speaker will change and warning lights behind the front grille will glow. If this occurs, immediately reduce the volume level to allow the components in the speaker to cool down.**

**Please remember that no protection circuits are 100% effective and that repeated activation could cause the circuits to fail.**

**Do not connect the speaker wires until the cones and rear braces have been installed according to the instructions included with the braces.**

## CONNECTING THE MODEL 3As

The Model 3As are optimized for bi-wiring or vertical bi-amplification. Separate heavy-duty screw terminal inputs for the bass portion and tweeter-midrange portion of the crossover are located on the rear of each speaker.

### BI-WIRING

Bi-wiring uses two speaker cables to connect each speaker to the amplifier. The speaker's internal crossover presents different electrical characteristics to each cable so that one cable carries the signal going to the woofers while the other cable carries the signal going to the midrange and tweeter. The improvements offered by bi-wiring versus a conventional single run of cable can be substantial. They are often large enough that a bi-wire set of moderately priced cable will sound better than a single run of far more expensive cable.

All the speaker cables in a bi-wire set should be the same. While it may be tempting to mix different models of cable to have a cable known for good bass response on the woofers and a different one known for good treble response on the midrange and tweeter, the differing sonic characteristics of the two cables can seriously affect the blending between the woofer and the midrange. The imaging of the speakers may be vague, transparency may be lost and detail and clarity can suffer.

Research has revealed that much of bi-wiring's benefit comes from the physical separation of the bass cable from the midrange/tweeter cable. Four conductor bi-wire cables that combine the wires together in one sheath are better than mono-wiring with an equivalent two-conductor cable, but they do not offer the full advantages of true bi-wiring.

### BI-AMPLIFICATION

The Model 3As can only be bi-amplified passively

with two identical stereo amplifiers, preferably in a vertical configuration. (One stereo amplifier per speaker.) For Model 3A owners that already own two identical stereo amplifiers or can easily acquire a second stereo amplifier that matches the one they have, bi-amplification may offer some advantages over bi-wiring. It should be noted however, that bi-amplification usually offers only slight to moderate sonic improvements over bi-wiring so two lesser amplifiers will normally not outperform a single better amplifier. Unless you already have two identical amplifiers or easy access to a second matching amplifier, you are better off investing in the best single amplifier within your budget rather than dividing your budget between two less expensive and inferior sounding amplifiers.

When bi-amplifying, the speaker's internal passive crossover divides the frequencies by presenting different electrical characteristics to each channel of the amplifier. An electronic crossover is not used since the passive crossover in the Model 3A cannot be bypassed. Use of an electronic crossover would result in the two crossovers acting in series and would cause severe phase shift and response non-linearities.

The Model 3As should not be bi-amped with two different amplifier models in a horizontal mode. (One amplifier driving the woofers and the other amplifier driving the midrange and tweeter.) When half of the speaker is driven by a different amplifier model than the other half—and in these cases, usually by amplifiers chosen for the differences in their sounds rather than the similarities—the blending between the woofer and midrange is compromised and the sonic consistency of the speaker is affected. The upper and lower halves of the speaker will exhibit different dynamic characteristics, imaging characteristics, tonal balances and degrees of detail. This will cause considerable sonic confusion through the middle frequencies.

**It is easy to connect a cable out of phase when using this connection method. Carefully verify cable polarity at speaker and amplifier.**

**Bare wires should never come into contact with the aluminum dress plate while the amplifier is on. Amplifier damage could result.**

**The input screws should be snug, but should not be overtightened.**

## BI-WIRE CONNECTIONS

Bi-wiring provides the sonic attributes of bi-amping without the cost and complexity of two stereo amplifiers. Bi-wiring is recommended for all systems using a receiver, integrated amplifier or single stereo amplifier. Four identical runs of equal length speaker cables are required. (Two per speaker.)

1. Crimp and solder spade lugs to the speaker ends of the cables being used to connect the Model 3As.
2. Choose one of the cables as the tweeter/midrange cable. Connect the ground side of the chosen cable under the top left terminal screw and the positive side of the cable under the top right terminal screw.
3. Connect the ground side of the remaining cable under the lower left terminal screw and the positive side of the cable under the lower right terminal screw.
4. Connect both cables in proper polarity to the same set of outputs on your amplifier. If possible, use only one spade lug to connect both cables to each terminal on the amplifier as shown in the enlarged view of an amplifier connection.

## FOR BETTER SOUND

- a. All four speaker cables should be the same type and length. While certain different cable types may work well together, using identical cables on the top and bottom insures perfect blending.
- b. Use high quality cables and spade lugs. Crimp and solder the spade lugs to the cables.
- c. If your amplifier has "A" and "B" outputs, use the "A" outputs for both cables. The two sets of outputs may not be electrically identical.
- d. If your amplifier has multiple impedance taps, both cables should be connected to the same tap.

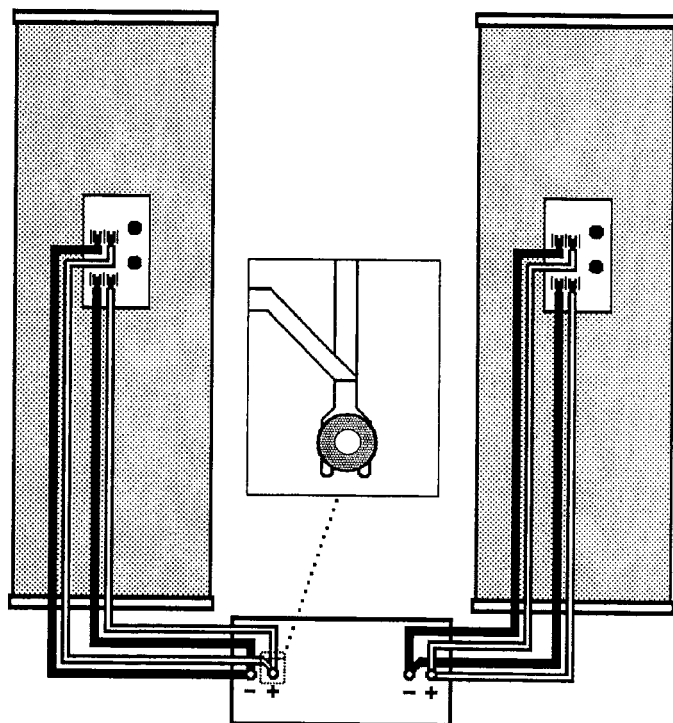
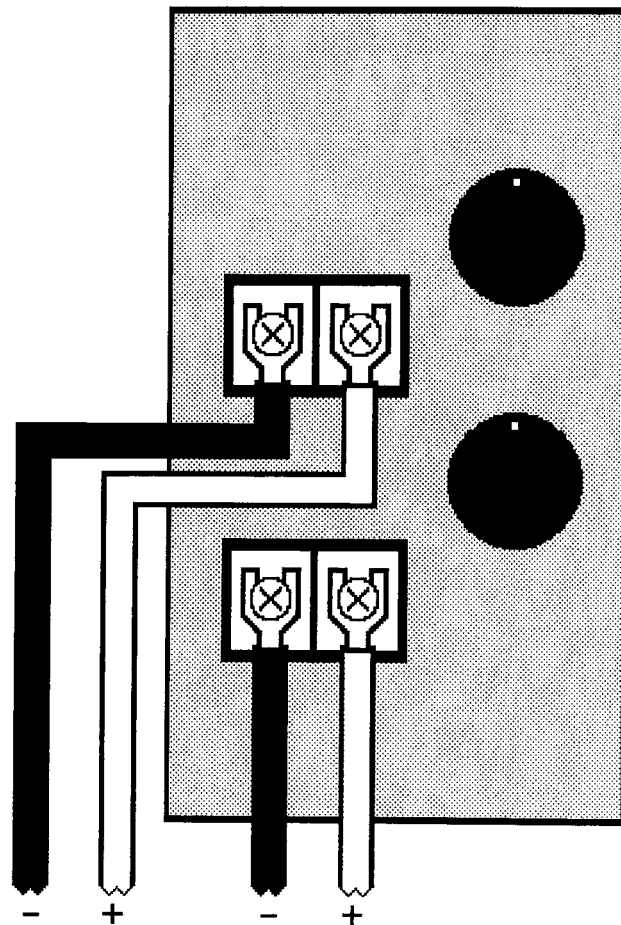

**This connection method can only be used in a system configured with two identical stereo amplifiers.**

**Bare wires should never come into contact with the aluminum dress plate while the amplifier is on. Amplifier damage could result.**

**The input screws should be snug, but should not be overtightened.**

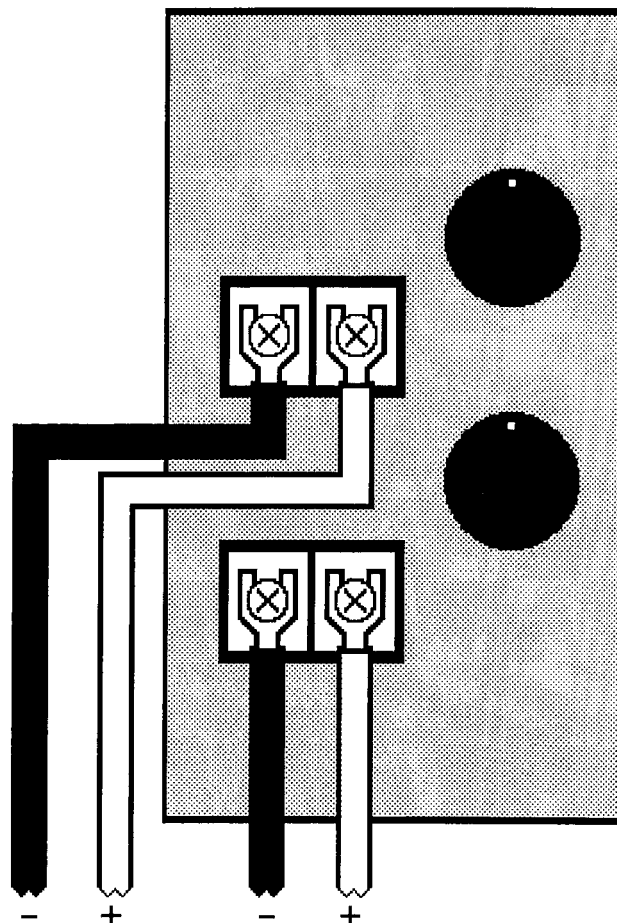

## VERTICAL BI-AMP CONNECTIONS

Vertical Bi-amplification uses a stereo amplifier to drive each speaker. Four identical runs of equal length speaker cables are required. (Two per speaker.)

1. Connect two cables to each speaker as described in steps 1-3 on the previous page.
2. Designate one stereo amplifier as the left channel amplifier and the other identical stereo amplifier as the right channel amplifier.
3. Use high quality single female to dual male "Y" connectors to connect the preamp's left channel output to both inputs of the left amplifier and the preamp's right channel output to both inputs of the right amplifier as shown in the diagram.
4. Connect the bass cable from the left speaker to one output channel of the left amplifier and the tweeter/midrange cable from the left speaker to the other output channel of the same amplifier.
5. Connect the bass cable from the right speaker to one output channel of the right amplifier and the tweeter/midrange cable from the right speaker to the other output channel of the same amplifier.

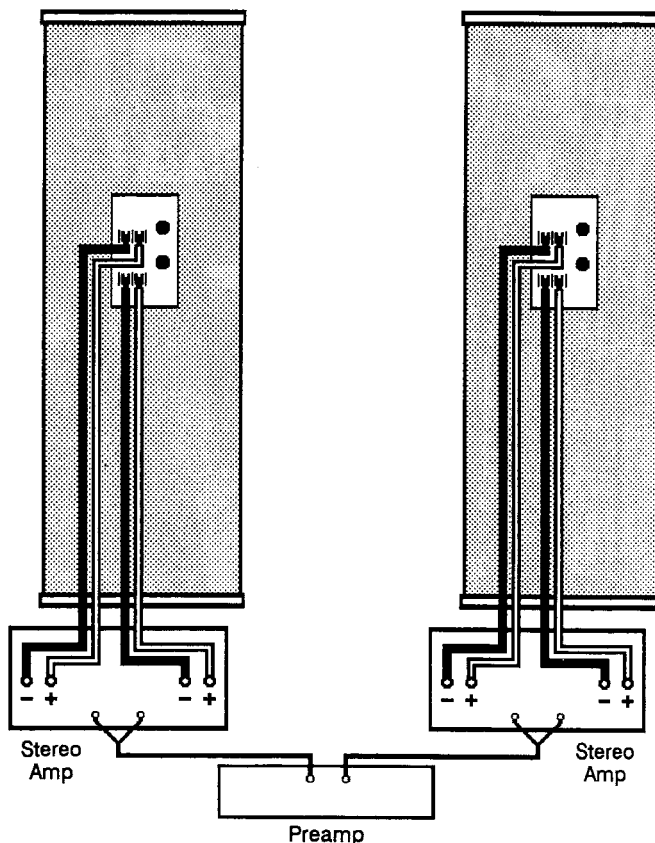

## FOR BETTER SOUND

- a. Verify with the amplifier manufacturer that your amplifiers are the same generation and sound the same.
- b. If your amplifiers have multiple impedance taps, both cables should be connected to the same rated taps.
- c. All four speaker cables should be the same type and length. While certain different cable types may work well together, using identical cables on the top and bottom insures perfect blending.

**The performance of the Model 3As is compromised by a mono-wire connection. They should be bi-wired as soon as possible.**

**Bare wires should never come into contact with the aluminum dress plate while the amplifier is on. Amplifier damage could result.**

**The input screws should be snug, but should not be overtightened.**

## MONO-WIRE CONNECTIONS

Mono-wiring should only be used with the Model 3As as a temporary connection method. The speakers should be bi-wired as soon as possible.

1. Cut two sections of wire about 2½ inches long to make two jumper wires.
2. Crimp and solder spade lugs to all four ends of the two jumper wires.
3. Connect one end of a jumper wire under the top left terminal screw and one end of the other jumper wire under the top right terminal screw.
4. Crimp and solder spade lugs to the speaker ends of the cable from the amplifier.
5. Connect the ground side of the speaker cable and the jumper cable from the top left terminal screw under the lower left terminal screw.
6. Connect the positive side of the speaker cable and the jumper cable from the top right terminal screw under the lower right terminal screw.
7. Connect the speaker cables to your amplifier, ground to ground and positive to positive.

## FOR BETTER SOUND

- a. The speaker cables should as short as possible and the same length. Consider putting the amplifier between the speakers rather than off to one side.
- b. Use quality cables. Keep all connections clean and tight.
- c. Bi-wire or bi-amplify as soon as possible for optimum performance.

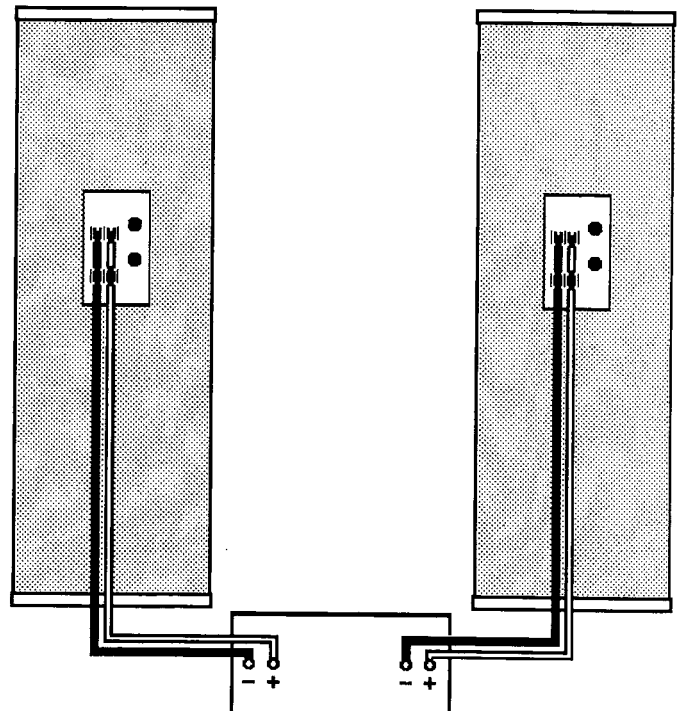
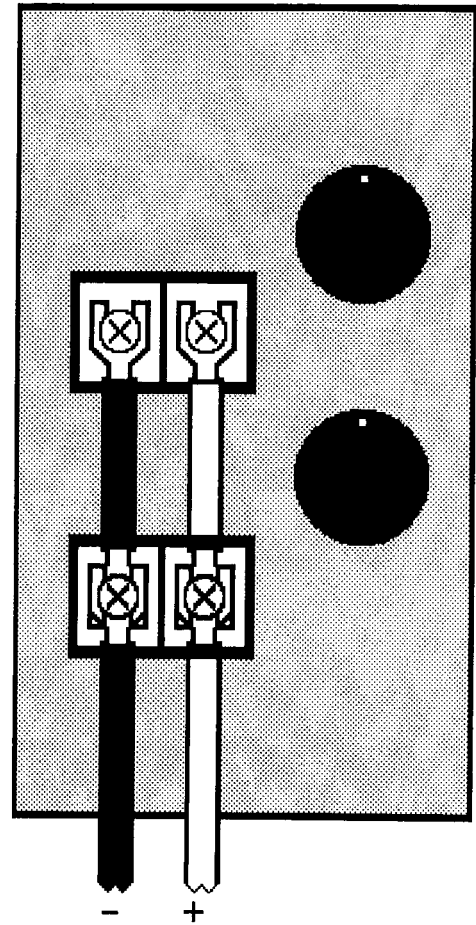

# SETTING-UP THE MODEL 3As

## LISTENING HEIGHT

All properly aligned loudspeakers have a vertical listening window where their sound is optimized. The Model 3A's six inch high optimum listening window is centered at 35 inches when the speakers are vertical. If your ear height is above 35 inches at your normal listening position, the speakers should be leaned back to raise the optimum listening window up to your ear height. The chart to the right shows how much the speakers should be leaned back for different ear heights and listening distances.

1. Measure the distance from the listening position to the speakers and the height of your ears when you are seated at your listening position. (Ear height is roughly equal to the height of the tip of your nose)
2. Find the values closest to your actual measurements on the chart to the right.
3. Follow the horizontal line across from your listening distance and the vertical line up from your ear height to the point where they intersect. The heavy lines numbered from 0 to 2½ indicate how many inches the top of the speaker should be behind the bottom of the speaker to center the listening window at your listening height and distance.
4. Adjust the length of the spike or cone on the rear brace of each speaker to lean the speakers back the proper amount.
5. As an example of how to measure for the proper amount of lean:
  - a. Tie a nut to a piece of thread about five feet long.
  - b. Hang the thread and nut from the back of the speaker and measure the distance the nut is away from the bottom of the speaker as shown in the diagram. This measurement is the amount of speaker lean. (For clarity, the amount of lean in the diagram has been exaggerated and the rear brace is not shown.)
  - c. Secure the rear spike or cone.

Distance From Speakers In Feet

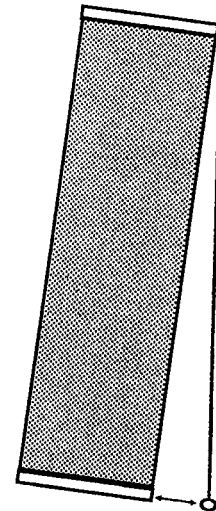
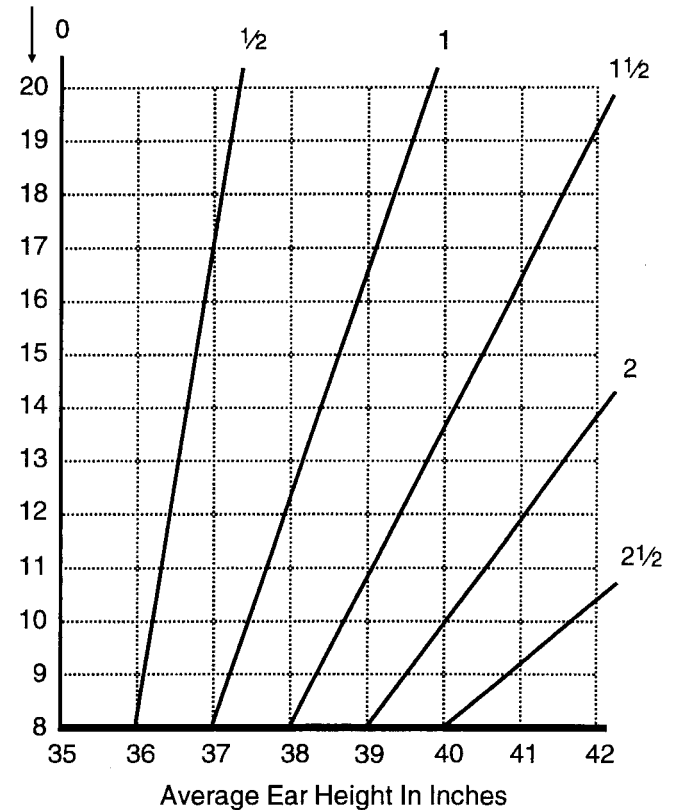

**The Model 3As break-in and significantly improve during the first 100 hours of use. Until this period has elapsed, the speakers exhibit some sonic aberrations as the parameters of the Model 3A were established with completely broken-in drivers.**

**One way to speed-up the break-in process is to let the system play at a moderate volume level 24 hours a day for a week or so. Playing the speakers louder than a moderate level will not shorten the break-in period.**

Vandersteen speakers will produce excellent, satisfying sound placed almost anywhere in a room. With all the possible variables in room layout, there are no magical formulas for determining the best speaker placement in every room. Since every room is different, we recommend that you try the speakers in every domestically acceptable location to find where they sound the best in your particular listening environment. The following sections contain suggestions that may be helpful in your placement experiments.

## SPEAKER PLACEMENT

Problems can arise when you attempt to place a given loudspeaker, either front radiating or dipole, into a typical domestic environment. These problems are a function of the physical dimensions of the room. The room's dimensions dictate where in the room a node or anti-node will occur. Frequency response dips and peaks caused by nodes and anti-nodes can easily overwhelm the inherent accuracy of a loudspeaker.

If, for example, you place a loudspeaker with excellent frequency response characteristics in the corner of a room, you will increase response below about 200Hz by 6dB. This particular condition is a worst case example, but similar conditions apply throughout the room to some extent.

### ODD DIMENSIONS PLACEMENT

Research on speaker placement has produced a method for reducing the nodes and anti-nodes in many rooms by positioning the loudspeakers on the odd dimensional intersections of the room. The odd dimensional intersections are the intersections of the imaginary lines you would draw if you divided the length of your room and the width of your room by odd numbers.

As an example, we will use a rectangular room measuring 14 feet wide by 18 feet long. We'll assume that you want to set the speakers on one of the short walls, although this method works equally well for long wall placement.

The first step is to take the length of the room, (18 feet in our example) convert it from feet to inches, (18 x 12 = 216) and divide the result by odd numbers.

216 divided by 3 is 72 (all to the nearest inch)

216 divided by 5 is 43

216 divided by 7 is 31

216 divided by 9 is 24

216 divided by 11 is 20

216 divided by 13 is 17

(And so on, eventually the lines start to pile on top of each other or the speaker runs into the wall.)

The results are the distances in inches that the

center of the speakers can be placed into the length of the room, away from the wall behind them, to minimize nodes and anti-nodes.

Now we can graph these odd dimensions distances on a drawing of the room. We only need to graph them for the wall where we intend to place the speakers.

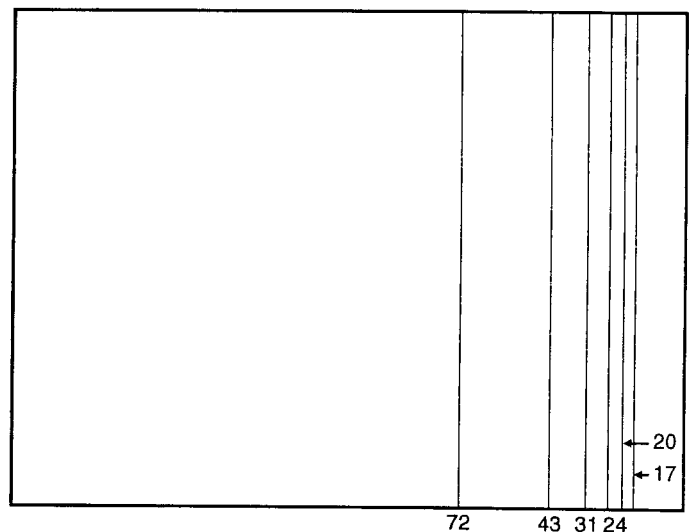

We use the same method to figure how far the centers of the speakers should be from the side walls. We take the width of the room, (14 feet) convert it from feet to inches, (14 x 12 = 168) and divide the result by odd numbers.

168 divided by 3 is 56 (all to the nearest inch)

168 divided by 5 is 34

168 divided by 7 is 24

168 divided by 9 is 19

168 divided by 11 is 15

The results of these odd number divisions are the distances in inches that the center of each speaker can be placed into the width of the room, away from the side wall, to minimize nodes and anti-nodes.

Now we can graph these odd dimensions distances on a drawing of the room.

	15
	24
	34
	56
	56
	34
	24
	15

By overlaying the width and length graphs, we can see the intersection points of the lines. These points represent where the centers of the speakers should be placed to minimize nodes and anti-nodes.

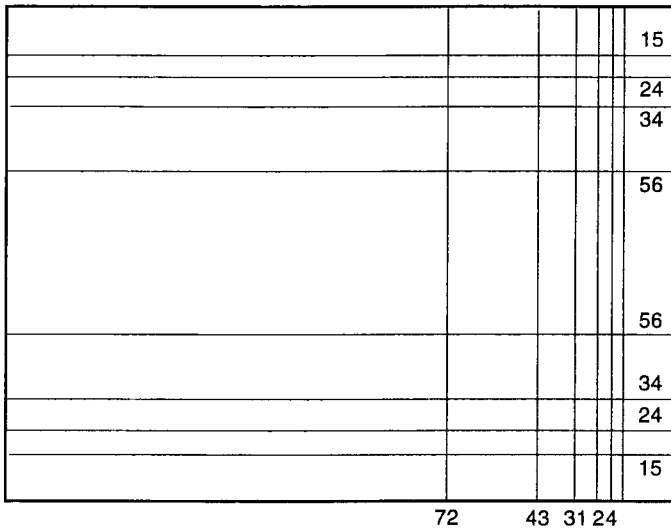

As you can see, we now have quite a few intersections to choose from in our example room. Some of the intersections in your room will probably be eliminated by aesthetic or room function considerations, so you probably will not have as many.

As you try different placements for your speakers, always place both speakers on the same length line. For example, both speakers would be placed on the 43 inch line or both speakers would be placed on the 24 inch line. The speakers can be placed on different width lines, for example one on the 34 inch line and the other on the 56 inch line. Placing the speakers on different rather than matching width lines will require that the listening position be offset to center it between the speakers. Often, the bass response of the system will be slightly more linear with the speakers placed on different width lines, (asymmetrical placement) while the imaging will often be better with the speakers placed on matching width lines (symmetrical placement).

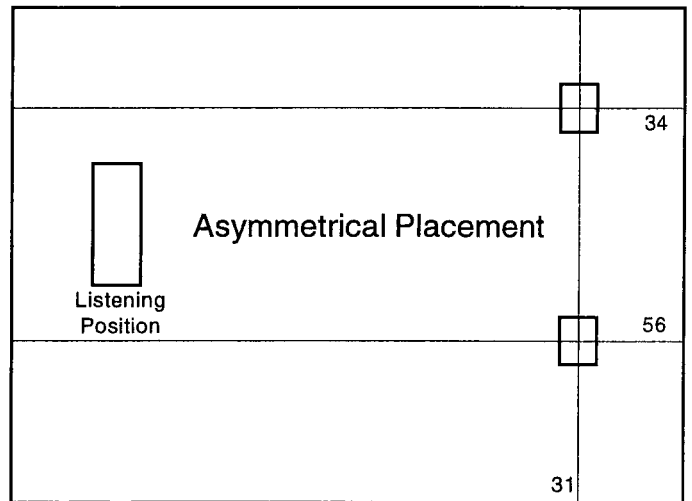
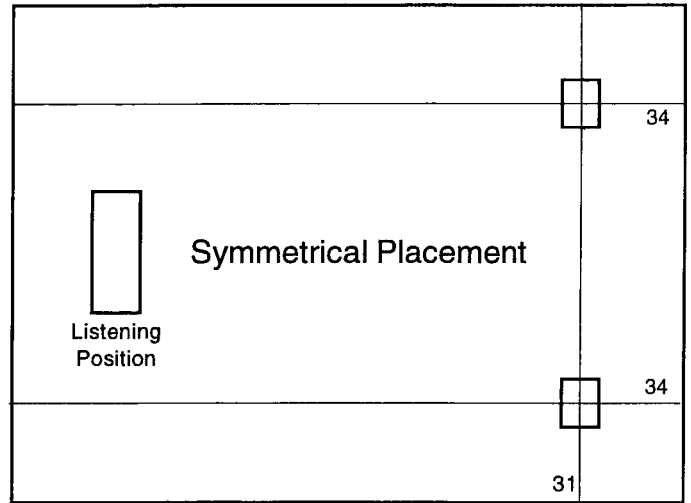

After listening to the speakers centered on the charted intersections, you should listen with the speakers a couple of inches away from the intersection points in each direction. In some cases, the speakers will sound better slightly off the intersections due to the particular characteristics of your room or a slight error in your original room measurements. Both speakers should be moved the same amount forward or backward when fine-tuning placement.

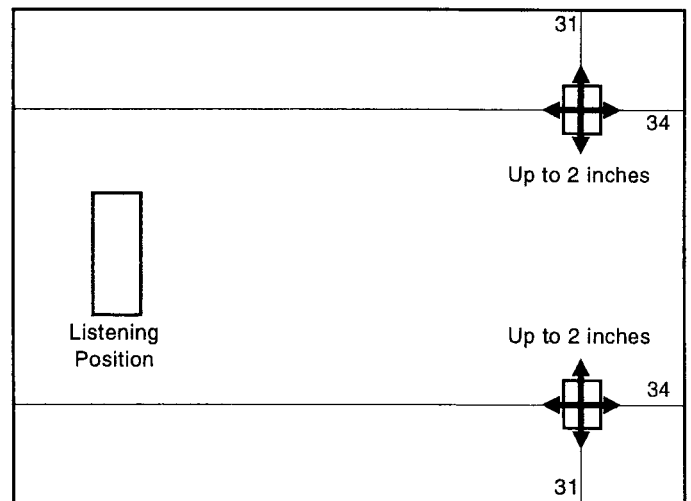



Several factors influence how speakers interface with a room other than the room's basic dimensions so it is possible that none of the placement options on the wall you initially place the speakers on will sound quite right. The sound may have too much or too little bass or be too forward or too withdrawn. If you are unable to achieve satisfactory sound with the speakers placed on one wall, try placing the speakers on another wall of the room. Even in a rectangular room, the speakers will interface differently with the room depending upon which of the four walls they are placed. In some rooms the speakers will sound best placed on a short wall while in other rooms the speakers will work better placed on a long wall.

### THIRD DIMENSIONS PLACEMENT

A placement method that provides some unique effects is to place each speaker on the thirds of the room measurements and the listening position on the third of the length. The speakers are placed one third the length of the room from the wall behind them and one third the width of the room from the walls along side them. The listening position is then placed one third the length of the room from the wall behind it.

In our 14 by 18 foot example room, the thirds are 72 inches in the long dimension and 56 inches in the short dimension. The intersections of these measurements are used for third dimensions placement. In addition, the listening position is placed 72 inches from the rear wall of the room.

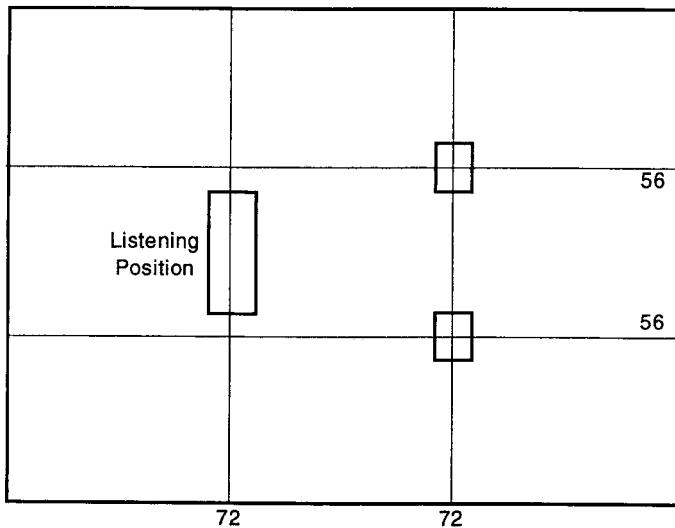

Both speakers should be tried up to two inches ahead and behind the intersections to determine if this improves the sound. Both speakers should be moved the same amount forward or backward.

Third dimensions placement reduces the interaction of the speakers with the room to an absolute minimum, but can create aesthetic or room function problems due to the speakers and listening position being so far out into the room. (The lower the odd number used to divide the room dimensions the lower the interaction between the speakers and the room.)

### ACOUSTICAL CENTER

The Model 3A's acoustical center is the physical center of the loudspeaker. In a perfect rectangular room with absolutely rigid walls and no doors or windows, the acoustical center of the loudspeaker would be placed exactly at the point where the two dimensions intersect to realize the full benefits of odd dimensions or third dimensions placement. In a real room, the actual best placement may vary from the intersection by as much as two inches or so. Fine-tuning the placement by moving the speakers a couple of inches off the odd dimension intersections takes these real world conditions into account.

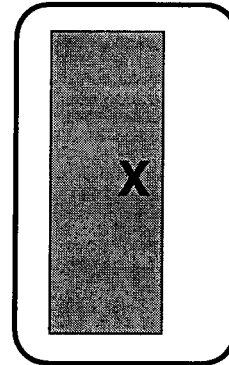

No placement should be used that would place the acoustical center of the loudspeaker the same distance from the rear and side walls. The measurement from the center of the loudspeaker to the two walls should differ by at least two inches. If any of the odd dimension intersections are within two inches of the same distance from both the side and rear wall, those intersections should not be used.

### SPEAKER TOE-IN

The degree of toe-in can affect the imaging and response characteristics of the speakers. In most rooms, the speakers will sound best facing straight ahead or slightly toed-in. Speakers that are placed close to the side walls or in rooms with very reflective side walls may require additional toe-in to avoid a confused image and/or a forward midrange and treble.

If the speakers need an excessive amount of toe-in to image properly or achieve good center fill, there may be a problem with the set-up or connection of the speakers or some part of the system may not be functioning as intended. To determine why the speakers require excessive toe-in, check all your speaker wire connections for correct phase and verify that the electrical components in the system are connected and functioning properly.

### ACOUSTIC TREATMENTS

If the speakers are close to the side walls and you hear a brightness in the midrange/treble or a problem with the imaging that toeing-in the speakers does not help, some sound absorbent material should be

mounted on the side walls to control reflections.

To determine where the sound absorbent material should be placed, imagine that the walls are mirrors and mount the material on the walls where you would see the reflections of the speakers when you are sitting in your normal listening position. Before you actually mount anything on the side walls, experiment with a folded natural-fiber blanket to verify the positioning of the material and that you will get the results you desire.

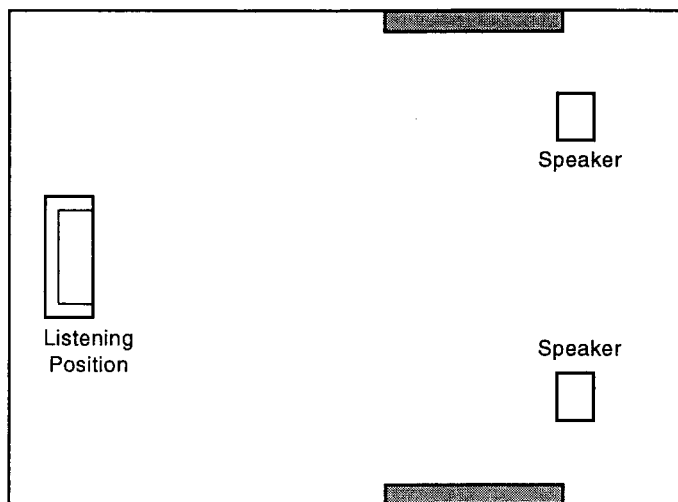

If your listening position is close to the wall behind you, mount some sound absorbent material, such as a hanging tapestry, directly behind your head. As with the material for the side walls, experiment with a folded natural-fiber blanket to verify the results before you acquire or mount the material.

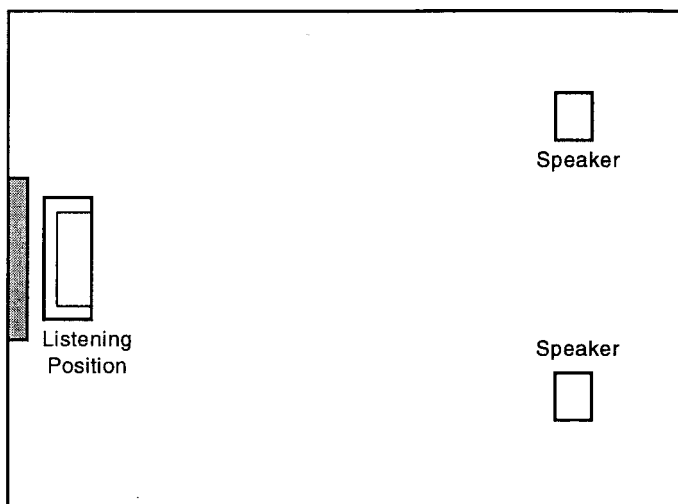

Bass problems that cannot be corrected with placement adjustments may be helped by the addition of bass traps or other bass control devices. Follow the instructions of the bass control devices as to their proper set-up and placement to correct the problems you are experiencing.

## HELPFUL HINTS

- To try the speakers on different walls, set your equipment in the middle of the room so the speaker cables can reach each possible location.
- When you change the placement of the speakers, listen to several different pieces of music before judging the results of the change.
- If you set the speakers on a wood floor, place a coin under each cone or spike or use rounded head carriage bolts; 1/4-20 thread bolts in place of the cones and 3/8-16 thread bolts in place of the spikes.
- When you have discovered the optimum speaker positioning in your room, mark it with tape so you can move the speakers to vacuum without losing your placement reference.
- If the bass is ill-defined in your room regardless of where you place the speakers, check your windows for loose panes of glass. Loose glass will vibrate and can seriously impair the low frequency detail of the system.
- Don't over-analyse the sound of each placement. When the sound is right, it will be obvious.
- Keep notes on the sound of different placements you try. It is easy to get mixed-up and forget which placement sounded the best.

## PLACEMENT NOTES

---

---

---

---

---

---

---

---

---

---

---

---

## THE CONTOUR CONTROLS

Two contour controls are located on the aluminum dress plate at the rear of the Model Three. The upper control adjusts the tweeter level and the lower control adjusts the midrange level.

The contour controls can be used to compensate for a bright or dull room that can not be corrected with speaker placement, acoustical treatments or other passive means. The controls are limited in their effects and even at maximum rotation they will not take the response of the speaker out of a plus or minus 3dB envelope. Changing the contour controls will not affect

the detail, imaging or phase performance of the speakers due to the unique incorporation of the controls into the crossover circuitry.

When using the controls, we recommend that you start with small adjustments and only change the midrange controls or tweeter controls before listening to the effects of the change. By changing only one pair of controls at a time, you will be able to easily determine the effects that each pair of controls have upon the sound of the speakers in your room.

## DESIGN AND SPECIFICATIONS

A precisely aligned dynamic design, blending common sense innovations with proven technology, gives the Model 3A many advantages:

- Computer optimized driver placement and cabinet design virtually eliminate the interference patterns usually associated with multi-way speakers.
- The lack of out-of-phase rear wave cancellations and interpanel interference allows many placement options in the listening room.
- The basic design concepts produce extended dynamic range and a point-source wave front for correct soundstage replication.
- The overall polar response pattern resembles the studio microphone pick-up pattern for better imaging and a broader listening area.
- High efficiency and a smooth impedance curve provide unlimited amplifier compatibility.

**Acoustic Coupler:** Long-throw, dual-spider active 10" with a critically damped ultra-rigid cone and heavy-duty 1.5" four-layer voice coil on a ventilated aluminum former. Range of operation: 26Hz to 35Hz

**Woofers:** Long-throw 8" with a die-cast basket and curvilinear polycone. 1.5 inch, two-layer voice coil on a ventilated aluminum former. 40 oz focused-gap magnet structure. Range of operation: 35Hz to 600Hz

**Midrange:** 4.5" with a patented, low-diffraction magnet and die-cast basket, linear surround and curvilinear polycone. Ferrofluid voice coil cooling. Range of operation: 600Hz to 5kHz

**Tweeter:** 1" critically damped, dual chamber metal alloy dome with ferrofluid voice coil cooling. Range of operation: 5kHz to 30kHz

**Crossover:** 600Hz and 5kHz. First-order, 6dB per octave. Dual inputs allow bi-wiring with a single stereo amplifier or passive vertical bi-amplification with two identical stereo amplifiers.

**Impedance:** 6 ohms nominal. 4 ohms minimum.

**Efficiency:** 88dB, 2.83 volt input at 1 meter.

**Response:** 26Hz to 30kHz  $\pm$  3dB  
30Hz to 22kHz  $\pm$  1.5dB  
By FFT step function.

**Amplification:** 100 to 200 watts per channel into 8 ohms. The amplifier should be stable into a 4 ohm load

**Physical:** 48" high x 16" wide x 10.25" deep. 89 pounds net, 102 pounds gross each.

*Specifications and design subject to change without notice due to our continuing research and development programs.*

# ASSOCIATED EQUIPMENT

## AMPLIFIER REQUIREMENTS

The Model 3A is designed for use with amplifiers rated between 100 to 200 watts per channel into 8 ohms. Amplifiers in this power range will provide ample power for realistic listening levels in most situations. Amplifiers with less than 100 watts may not be able to drive the Model 3As to realistic listening levels without stress under all listening conditions. Amplifiers with more than 200 watts must be used with caution due to the increased potential for speaker damage if they are misused or an accident occurs.

The Model 3As are very revealing speakers and are easily capable of showing the subtle sonic differences between amplifiers. They will perform well with a tube, transistor or hybrid amplifier, allowing each

design to realize its full potential.

The stability of the amplifier to be used is very important as it will affect the current capability and therefore, the dynamics and realism of the music. A stable transistor amplifier will be able to deliver twice the wattage into a 4 ohm load as it does into an 8 ohm load. Amplifiers with this ability should perform well with the Model 3As.

Fuses between the amplifier and the Model 3A will degrade the performance of the entire system. No fuses are used in the Model 3A and preference should be given to the use of an amplifier that does not use output fuses.

## COMPONENTS

To maximize the performance of your system, you should properly set-up your components according to the manufacturer's instructions. Each component should be placed on a piece of furniture or in a stand that is stable and not prone to vibration or rocking. An isolation base or isolation feet may improve the sound

of some sources or electronics.

Allow sufficient air space around the electronics for needed air circulation. Excessive heat can both shorten the life of electrical components and impair their performance.

**Preamplifiers and CD players should be left on all the time. Amplifiers should be turned off when the system is not being used. Once broken in, modern power amplifiers sound good after only 20 minutes of warm-up. Leaving the amplifier on all the time exposes the speakers to possible damage from power line anomalies or electrical component failure while the system is unattended.**

## CABLES

Our research has convinced us that interconnect and speaker cables should be considered an integral part of the music system. Each brand and model of cable has its own sonic characteristics and contributes to the overall presentation of the music as much as any active component. The Model 3A easily passes the amount of information required to hear these differences between cables.

The research also confirmed the importance of keeping speaker cables as short as possible. In repeated trials, short runs of moderate to inexpensive speaker cable consistently outperformed long runs of the same cable as well as much more expensive cable. If you must place your speakers a long distance from your electronics, we recommend that you position the amplifier between the speakers so you can use longer interconnect cables with shorter speaker cables. With comparable lengths and quality, long interconnect

cables seem to compromise the sound of a system less than long speaker cables. An additional advantage is that a given length of interconnect cable will usually cost much less than the same length of bi-wired speaker cable. The amplifier you have placed between the speakers can easily be concealed by a plant or placed in a decorative piece of furniture.

To assure that they were sonically neutral, the Model 3As were developed using a direct coupled laboratory amplifier connection loaded by precision resistors to simulate cable resistance. However, with the wide diversity of associated equipment, environments and personal listening tastes, there is no single make or model of cable that will fit all situations. One system may sound best with lively cables while another system may sound best with subdued cables. You have to determine which cables in your price range complement the characteristics of your particular system

and environment and present the music the way you wish to hear it in your home.

When you evaluate different interconnect or speaker cables, remember that the dielectric in most

quality cables takes several hours to fully form. These cables may not reach their full potential until they have been in the system for a week or more.

## AUDIO/VIDEO CONSIDERATIONS

When Model 3As are used in an A/V system, their setup, positioning, listening height and amplifier requirements are the same as in a music system. They should be matched with phase correct center and surround speakers to maintain the time and phase coherency of the original sounds. The Model 3As are not magnetically shielded and should be kept at least a foot away from a direct view television to avoid interfering with the picture.

With the incredible sound effects of modern films, subwoofers are an integral and required part of an A/V

system. While it may seem redundant to add subwoofers to speakers with the excellent bass capabilities of Model 3As, you actually need full-range main speakers like the Model 3As to insure an accurate and predictable crossover to the subwoofers. If the Model 3As are used as the main speakers in an A/V system without subwoofers, they should not be played at high levels where the woofers or active acoustic couplers are overdriven by intense low-frequency effects. High playback levels on video sources require subwoofers.

## MODEL 3A CARE

### MAINTENANCE

The appearance and performance of the Model 3A can be enhanced by observing a few precautions and performing some simple maintenance.

The input terminals on the Model 3As and the spade lugs on the speaker wire should be cleaned periodically with alcohol or a solution made specifically for cleaning electrical contacts. Other connection points in the system should be cleaned as per the equipment manufacturer's recommendations.

The grille cloth on the Model 3As can be

vacuumed using a brush attachment that will not snag the cloth. The top should be treated as a piece of fine furniture. The wood veneers are oiled at the factory and can be maintained with a light application of Watco oil or a similar product.

Care must be taken that glasses and other objects that could mar the finish are not placed on top of the speaker. The speakers should not be exposed to excessive heat or direct sunlight which can damage the fit and finish of the veneer.

### SERVICE

Should your Model 3As require service, please follow these procedures.

1. Verify that the problem is in the speaker by physically switching the left and right speakers. If the problem does not follow the speaker, it is in a component or cable rather than the speaker.
2. Play the top half and bottom half of the suspect speaker separately to determine if the problem is in the midrange/tweeter section or the bass section.

2. Contact Vandersteen Audio, describe the problem and the steps you have taken to verify the problem is in the speaker. A return authorization form will be sent to you.
3. When you receive the return authorization form, return the damaged or defective speaker to Vandersteen Audio packed in its original carton according to the diagram and instructions on page 14 of this manual. Include the completed return authorization form in the box with the speaker.

### SUPPORT

This manual has covered the installation, use and capabilities of Vandersteen Model 3A loudspeakers. You should review this manual with anyone who will use your audio system to insure that they will exercise proper care and judgement.

Should you have any questions regarding your

Model 3As, you should consult your dealer. He has been selected to be a Vandersteen dealer due to his expertise regarding stereo equipment and its use. If your dealer is unavailable or unable to answer your questions, contact Vandersteen Audio and we will do our best to address your concerns.

# PACKING THE MODEL 3A

## PACKING INSTRUCTIONS

To prevent physical or cosmetic damage, always pack the Model 3As in their original boxes prior to transportation or shipment. Please follow these instructions when packing a Model 3A.

1. Turn off the amplifier and disconnect the speaker cables from the speaker.
2. Turn the speaker upside-down on a folded towel or carpeted surface and remove the rear brace and cones.
3. With the speaker still up-side-down, pull the plastic bag down over the speaker.
4. Slide the cardboard inner liner over the speaker.
5. Fit one of the end trays into the end of the inner liner **with the open area of the end tray facing away from the speaker.**
6. Holding the flaps out, slide the outer box over the inner liner all the way to the floor.
7. Carefully turn the box right-side-up.
8. Close the plastic bag and place the remaining end tray into the inner liner as was done in step 5.
9. Close the flaps on the outer box and seal with strong tape.
10. Put the cones and brace mounting bolts into a plastic bag and tape the bag to one of the braces for safe keeping.

**The open area of the end trays must always face away from the speaker.**

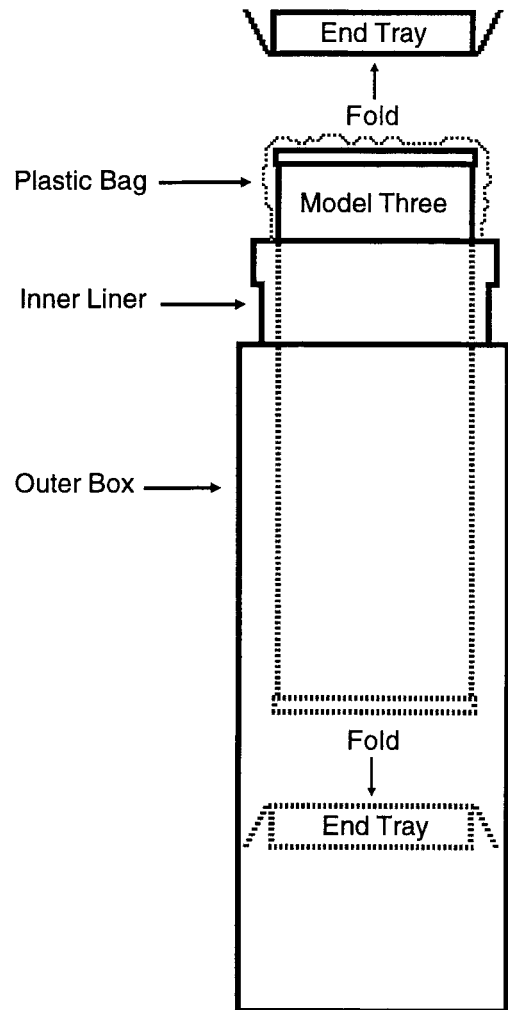

**Do not attempt to ship your speakers in anything other than an original specification box. New boxes and packing are available from Vandersteen Audio for a nominal charge.**

## VANDERSTEEN AUDIO

116 West Fourth St.

Hanford, CA 93230

(559) 582-0324

[www.vandersteen.com](http://www.vandersteen.com)

## LIMITED ONE YEAR WARRANTY

VANDERSTEEN AUDIO loudspeakers are warranted to the original purchaser to be free from defects in materials or workmanship, SUBJECT TO THE FOLLOWING CONDITIONS, for one (1) year from the date of purchase from an authorized VANDERSTEEN AUDIO dealer.

### THIS WARRANTY IS SUBJECT TO THE FOLLOWING CONDITIONS AND LIMITATIONS:

This warranty is void and inapplicable if the loudspeaker has:

- a. not been used in accordance with the instructions contained in the operation manual.
- b. been subject to misuse or abuse; examples of which would be burned driver voice coils.
- c. been modified, repaired, or tampered with by anyone not specifically authorized to do so by Vandersteen Audio.
- d. been subject to inputs in excess of the maximum rating, or inputs from an unstable or clipped amplifier.
- e. suffered physical damage to the structure or components due to accident, neglect, or transportation.

IF A VANDERSTEEN AUDIO LOUDSPEAKER FAILS TO MEET THE ABOVE WARRANTY AND THE ABOVE CONDITIONS HAVE BEEN MET, THEN THE CUSTOMER'S SOLE REMEDY SHALL BE TO RETURN THE PRODUCT TO VANDERSTEEN AUDIO WHERE THE DEFECT WILL BE REPAIRED WITHOUT CHARGE FOR PARTS OR LABOR. THIS WARRANTY APPLIES ONLY TO PRODUCTS RETURNED TO VANDERSTEEN AUDIO IN HANFORD, CA USA.

(Returning the product to Vandersteen Audio from some countries other than the United States may involve considerable time and expense. The customer is responsible for all fees and duties and for providing instructions and all the paperwork required to return the product after it is serviced.)

The speaker must be packed in the original packing and returned to VANDERSTEEN AUDIO via insured freight by the customer at his or her own expense. A returned product must be accompanied by a Return Authorization Form, (available from VANDERSTEEN AUDIO upon request) which includes a written description of the defect and return shipping information.

ANY IMPLIED WARRANTIES RELATING TO THE ABOVE PRODUCT SHALL BE LIMITED TO THE DURATION OF THE ABOVE WARRANTY. THIS WARRANTY DOES NOT EXTEND TO ANY INCIDENTAL OR CONSEQUENTIAL COSTS OR DAMAGES TO PURCHASER.

Some states do not allow limitations on how long an implied warranty lasts, or an exclusion of incidental or consequential damages so the above limitations or exclusions may not apply. This warranty gives you specific legal rights, you may also have other rights in your state.

VANDERSTEEN AUDIO reserves the right to modify the design of any product without any obligation to previous purchasers and/or to change the prices or specifications without notice or obligation to anyone.

### A PERSONAL NOTE

**I have been doing volunteer work for several years with elderly people with severe hearing losses, and I have seen the frustration and anger that are brought on by these losses. We now know that many of these people developed their hearing problems because of exposure to high noise levels when younger.**

**Many home stereo systems, as well as audio/video, personal, and automobile sound systems are capable of volume levels potentially damaging to your hearing. Please use common sense, and listen to your music and movies at safe levels now so you will still have the ability to hear and enjoy them in the future.**



Richard Vandersteen