

Nakamichi RX-505

Unidirectional Auto Reverse
Cassette Deck

Owner's Manual

WARNING

TO PREVENT FIRE OR SHOCK HAZARD, DO NOT EXPOSE THIS APPLIANCE TO RAIN OR MOISTURE.

This equipment generates and uses radio frequency energy and if not installed and used properly, that is, in strict accordance with the manufacturer's instructions, may cause interference to radio and television reception. It has been type tested and found to comply with the limits for a Class B computing device in accordance with the specifications in Subpart J of Part 15 of FCC Rules, which are designed to provide reasonable protection against such interference in a residential installation. However, there is no guarantee that interference will not occur in a particular installation.

Please record the Model Number and Serial Number in the space provided below and retain these numbers.

Model Number and Serial Number are located on the rear panel of the unit.

Model Number: RX-505

Serial Number: _____

CONTENTS

Safety Instructions.....	3
On Cassette Tapes	3
Cassette Insertion and Removal	3
Controls and Features	4
Connections	5
Precautions Before Operation	6
Operation	6
The Auto-Reverse System	7
Special Features.....	8
Maintenance	11
Troubleshooting.....	11
Specifications.....	12

Removal of Transport Fastening Jig

Before connecting the cassette deck, remove the transport fastening jig on the bottom panel. Be sure to retain the fastening jig and screw, as these will be needed again for renewed transport or shipping of the cassette deck.

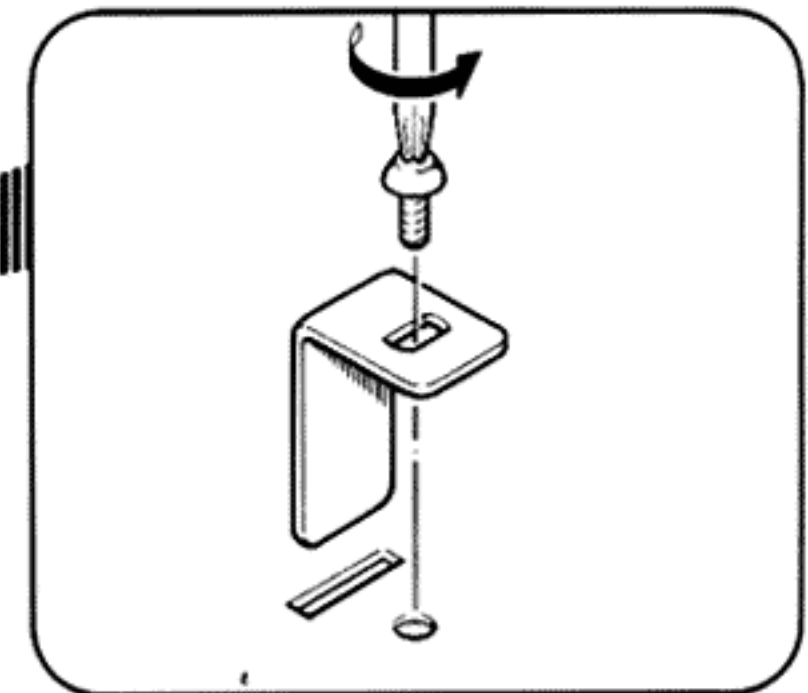
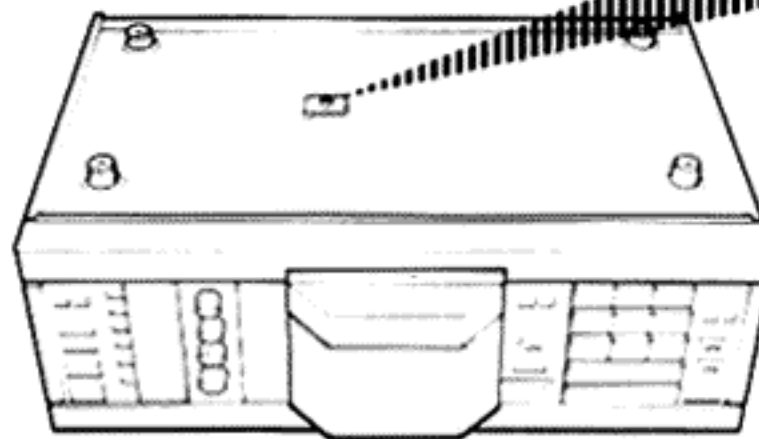

Safety Instructions

The following safety instructions have been included in compliance with safety standard regulations. Please read them carefully.

1. Read Instructions—All the safety and operating instructions should be read before the appliance is operated.
2. Retain instructions—The safety and operating instructions should be retained for future reference.
3. Heed Warnings—All warnings on the appliance and in the operating instructions should be adhered.
4. Follow Instructions—All operating and use instructions should be followed.
5. Water and Moisture—The appliance should not be used near water—for example, near a bathtub, washbowl, kitchen sink, laundry tub, in a wet basement, or near a swimming pool, etc.
6. Carts and Stands—The appliance should be used only with a cart or stand that is recommended by the manufacturer.
7. Wall or Ceiling Mounting—The appliance should be mounted to a wall or ceiling only as recommended by the manufacturer.

8. Ventilation—The appliance should be situated so that its location or position does not interfere with its proper ventilation. For example, the appliance should not be situated on a bed, sofa, rug or similar surface that may block the ventilation openings; or placed in a built-in installation, such as a bookcase or cabinet that may impede the flow of air through the ventilation openings.
9. Heat—The appliance should be situated away from heat sources such as radiators, heat registers, stoves, or other appliances (including amplifiers) which produce heat.
10. Power Sources—The appliance should be connected to a power supply only of the type described in the operating instructions or as marked on the appliance.
11. Grounding or Polarization—Precautions should be taken so that the grounding or polarization means of an appliance is not defeated.
12. Power-Cord Protection—Power-supply cords should be routed so that they are not likely to be walked on or pinched by items placed upon or against them, paying particular attention to cords at plugs, convenience receptacles, and the point where they exit from the appliance.

13. Cleaning—The appliance should be cleaned only as recommended by the manufacturer.
14. Nonuse Periods—The power cord of the appliance should be unplugged from the outlet when left unused for a long period of time.
15. Object and Liquid Entry—Care should be taken so that objects do not fall and liquids are not spilled into the enclosure through openings.
16. Damage Requiring Service—The appliance should be serviced by qualified service personnel when:
 - A. The power-supply cord or the plug has been damaged; or,
 - B. Objects have fallen, or liquid has been spilled into the appliance; or,
 - C. The appliance has been exposed to rain; or,
 - D. The appliance does not appear to operate normally or exhibits a marked change in performance; or,
 - E. The appliance has been dropped, or the enclosure damaged.
17. Servicing—The user should not attempt to service the appliance beyond that described in the operating instruction. All other servicing should be referred to qualified service personnel.

On Cassette Tapes

Precautions

1. C-120 cassettes (playing time one hour per side) contain extremely thin tape which breaks or snarls easily, is sometimes subject to stretching and also is of low sensitivity. Therefore, C-120 cassettes are not recommended for high-fidelity recording.
2. Do not pull out the tape from the cassette housing.
3. Be careful not to turn the cassette reels with the fingers, causing tape slackening.
4. Store cassette tapes away from heat, high humidity, dust, and magnetic fields such as caused by speakers, TV sets etc.

Cassette Tabs

You can protect valuable recordings from accidental erasure and re-recording by completely removing the appropriate tab on the top edge of the cassette. The tab for each side is located on the top left-hand corner as you face the side. Use a small screwdriver, and push the tab down to break it off. Do not leave the broken tab in the recess. If you wish at a later date to record

over a side for which the tab has been removed, cover the tab opening with a piece of adhesive tape.

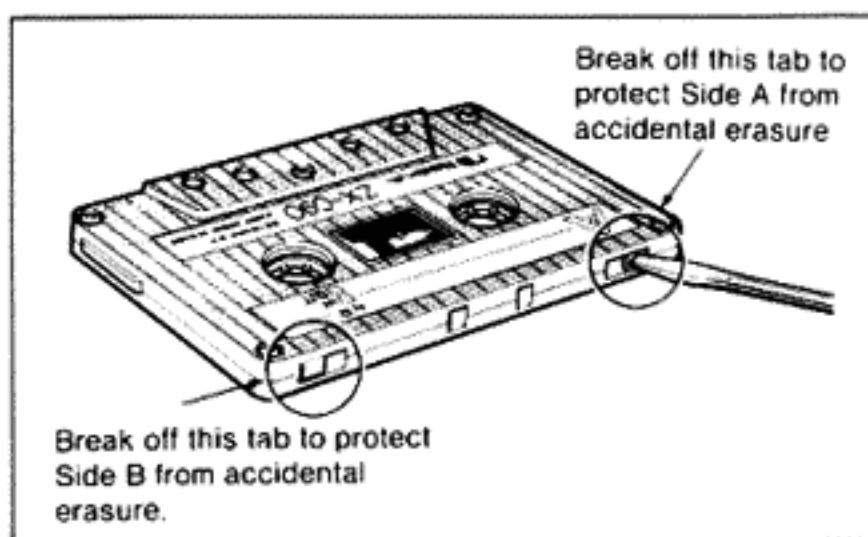

Cassette Insertion and Removal

(1) Insertion of a Cassette

1. By pressing the Eject/Load button, the cassette compartment slides out.
2. Place the cassette in the cassette holder with side A facing outward and the exposed tape facing up.
3. By pressing the Eject/Load button again, the cassette compartment is drawn in and the cassette is set in place. Also, if the Play, Fast-Forward or Rewind button is pressed in the eject condition, the cassette will be set at side A and

the respective mode will be entered without the need to press the Eject/Load button.

- To listen only to side B, press the Reverse button. The cassette will be set in reverse, with side B facing outward.

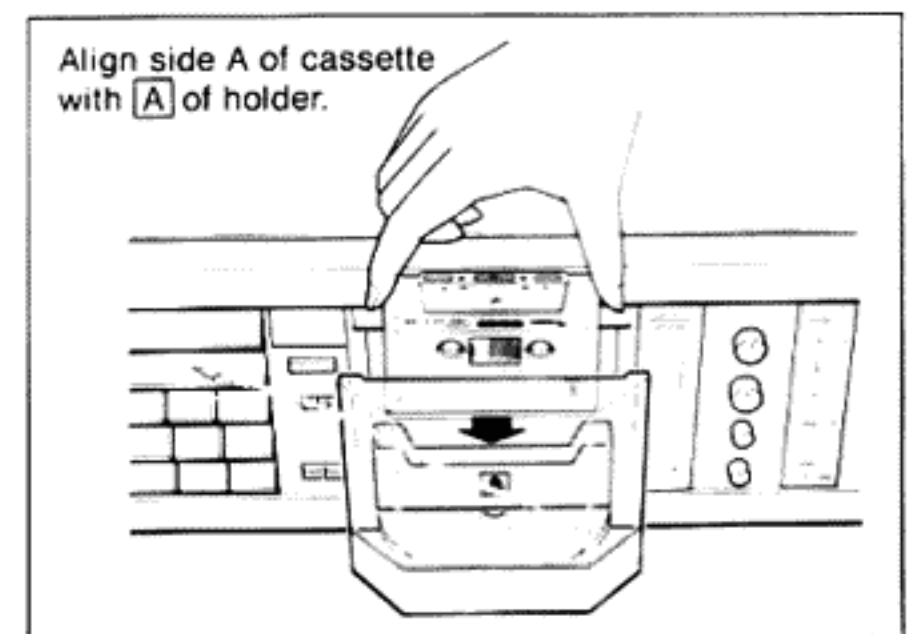

(2) Removal of a Cassette

1. By pressing the Eject/Load button in any operation mode, not only stop but also recording, playback, fast-forward, etc., the tape motion stops and the cassette compartment slides out. At this time, side A always faces outward (eject condition).
2. Remove the cassette.

Controls and Features

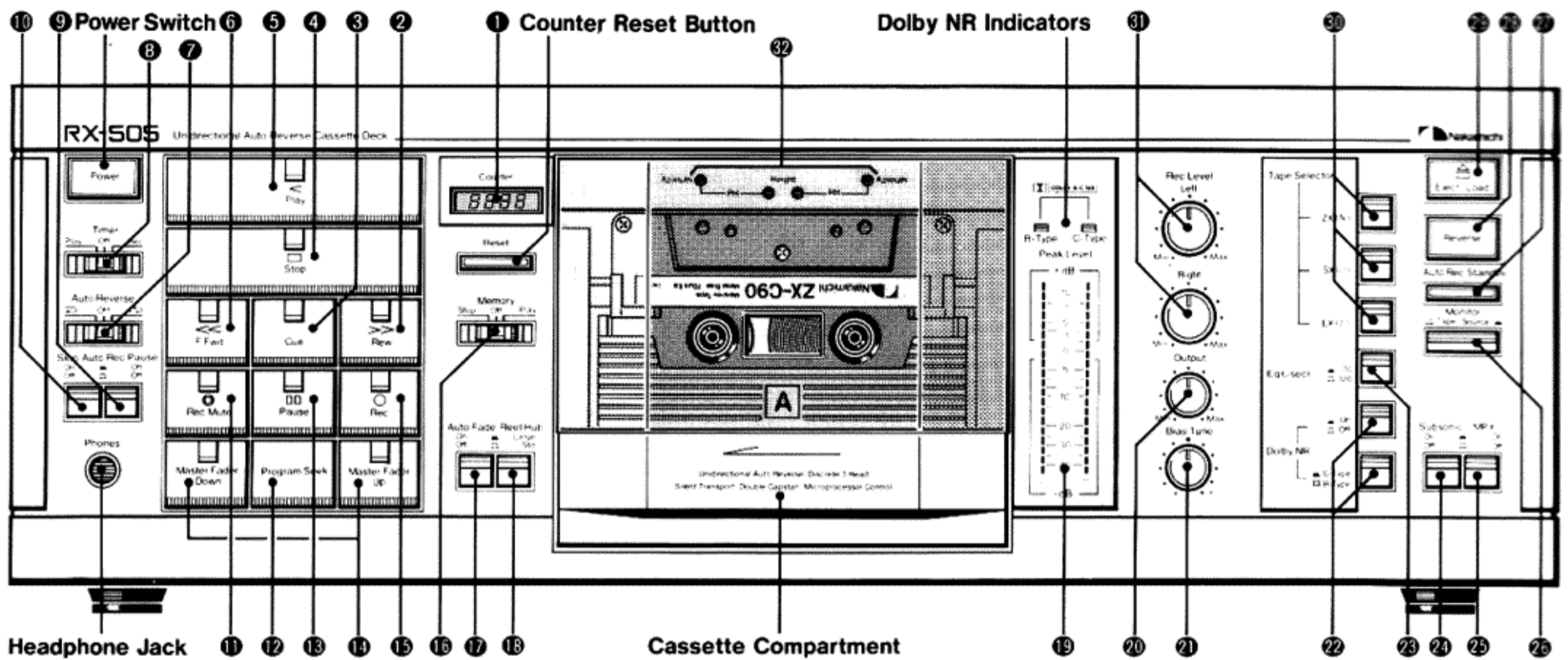

(1) Tape Counter

Starting from "0000", tape travel is indicated in the range from "9999" to "-999". Counter indication is reset to "0000" by pressing the Reset button, and also when the power is switched on, the tape is reversed, and the Auto Rec Standby operation is completed.

(2) Rewind Button

Used to rewind the tape rapidly. During operation, the indicator lights up.

(3) Cueing Button

Used for tape cueing to easily find a desired spot on the tape. During operation, the indicator above the button lights up.

(4) Stop Button

Used to completely stop the tape transport from any mode. During operation, the indicator above the button lights up.

(5) Play Button

Used to start playback or to start recording from the record-standby mode. During operation, the indicator lights up.

(6) Fast-Forward Button

Used to fast-forward the tape. During operation, the indicator lights up.

(7) Reverse Mode Switch

Serves to select the auto-reverse mode for recording and playback. (→p. 7)

(8) Timer Switch

This switch is used for timer-activated recording or playback. In ordinary operation, it must be set to "Off". (→p. 7)

(9) Auto Rec Pause Switch

When this switch is set to "On" in the record mode and the tape runs for more than 45 seconds without input signal (blank recording), the tape is automatically rewound for the equivalent of 30 seconds and then the deck goes into the record/pause (record-standby) mode. (→p. 9)

(10) Skip Switch

When this switch is set to "On" and a blank (unrecorded section) of more than 40 seconds is encountered during playback, the deck automatically goes into the fast-forward mode. (→p. 7)

(11) Rec Mute Button

By pressing this button during recording, the recording signal is cut off for as long as the button is kept depressed. During the operation, the indicator lights up. The indicator also is lit in the record-standby mode and the "Down" mode of the Master Fader, and it lights up momentarily when the Record button and Play button are pressed to start recording from the stop mode.

(12) Program Seek Button

When this button is pressed, the tape is fast-forwarded and playback automatically starts at the beginning of the next selection. By pressing the button in the rewind mode, the beginning of the present selection is located and playback starts from there. (→p. 9)

(13) Pause Button

Used to temporarily interrupt tape travel during recording or playback. During operation, the indicator lights up. To start the tape again, press the Play button.

(14) Master Fader Buttons

These buttons serve to perform fade-in and fade-out during recording. (→p. 10)

(15) Record Button

Used for recording. During operation, the indicator lights up.

(16) Memory Switch

When this switch is set to "Play" or "Stop", the respective function is performed automatically when the tape reaches the counter indication "0000" during rewind or fast-forward.

(17) Auto Fade Switch

When this switch is set to "On" in auto-reverse recording, automatic fade-out is performed at the end of side A and automatic fade-in at the start of side B. (→p. 8)

(18) Reel Hub Switch

When the Auto Fade function is used, this switch must be set to the position corresponding to the reel hub size of the cassette in use. (→p. 9)

(19) Peak Level Meters

Provide exact indication of peak levels in the range of -40 dB to +10 dB.

(20) Output Level Control

Serves adjust the line output level and the headphones listening level.

(21) Bias Tune control

Serves for fine adjustment of the bias current. (→p. 10)

(22) Dolby NR Switches

To use the Dolby NR system, set the upper-switch to "On" and select either the B-Type or the C-Type system with the lower switch. The respective indicator lights up.

(23) Equalizer Switch

Serves to select correct equalization in recording and playback for the tape in use. (→p. 10)

(24) Subsonic Filter Switch

Used to cut off harmful low-frequency noise such as turntable rumble etc. during recording from phonograph records. At other times, the switch should be set to "Off".

(25) MPX Filter Switch

Used to suppress the 19-kHz multiplex carrier signal, which could interfere with proper Dolby NR operation when recording from FM stereo broadcasts. At other times, the switch should be set to "Off".

(26) Monitor Switch

For playback of a tape and for off-the-tape monitoring during recording, this switch must be set to "Tape". For record level setting etc., the switch must be set to "Source".

(27) Auto Rec Standby Button

When this button is pressed, the tape is automatically rewound or fast-forwarded and runs from the start for 6 seconds in the Rec Mute condition. The deck then goes into the record-standby mode. (→p. 8)

(28) Reverse Button

Serves to reverse the cassette.

(29) Eject/Load Button

This button is used for ejection and insertion of the cassette.

(30) Tape Selector Switches

In recording, the correct switch must be selected for the tape in use. (→p. 10)

(31) Input Level Controls

Serve to separately adjust the recording level for left and right channel.

(32) Head Height and Azimuth Alignment Screws

These adjustments have been calibrated at the factory for optimum performance. DO NOT ATTEMPT RE-ADJUSTMENT. These adjustments should only be made by qualified service technicians.

Connections

After reading the instructions for your amplifier or receiver, use the shielded cables with RCA plugs (provided with the deck) to make connections as shown in the chart. Take care not to mix up left and right channels. While making connections, all power switches should be OFF.

Headphones with an impedance of 8 to 150 ohms can be connected to the Phones jack on the front panel.

Microphone Connections

As this deck has only line input facilities, a separate microphone mixer with line-level outputs must be used for microphone recordings. Connect the output of the mixer to the deck's "Line Input" jacks.

Nakamichi offers the optional MX-100 Microphone Mixer, which provides three inputs for left, right, and center blend (L+R). To power the MX-100, the separate PS-100 Power Supply is required.

Remote Control

The optional remote control unit RM-15 permits operation of the deck's tape transport functions from any convenient location.

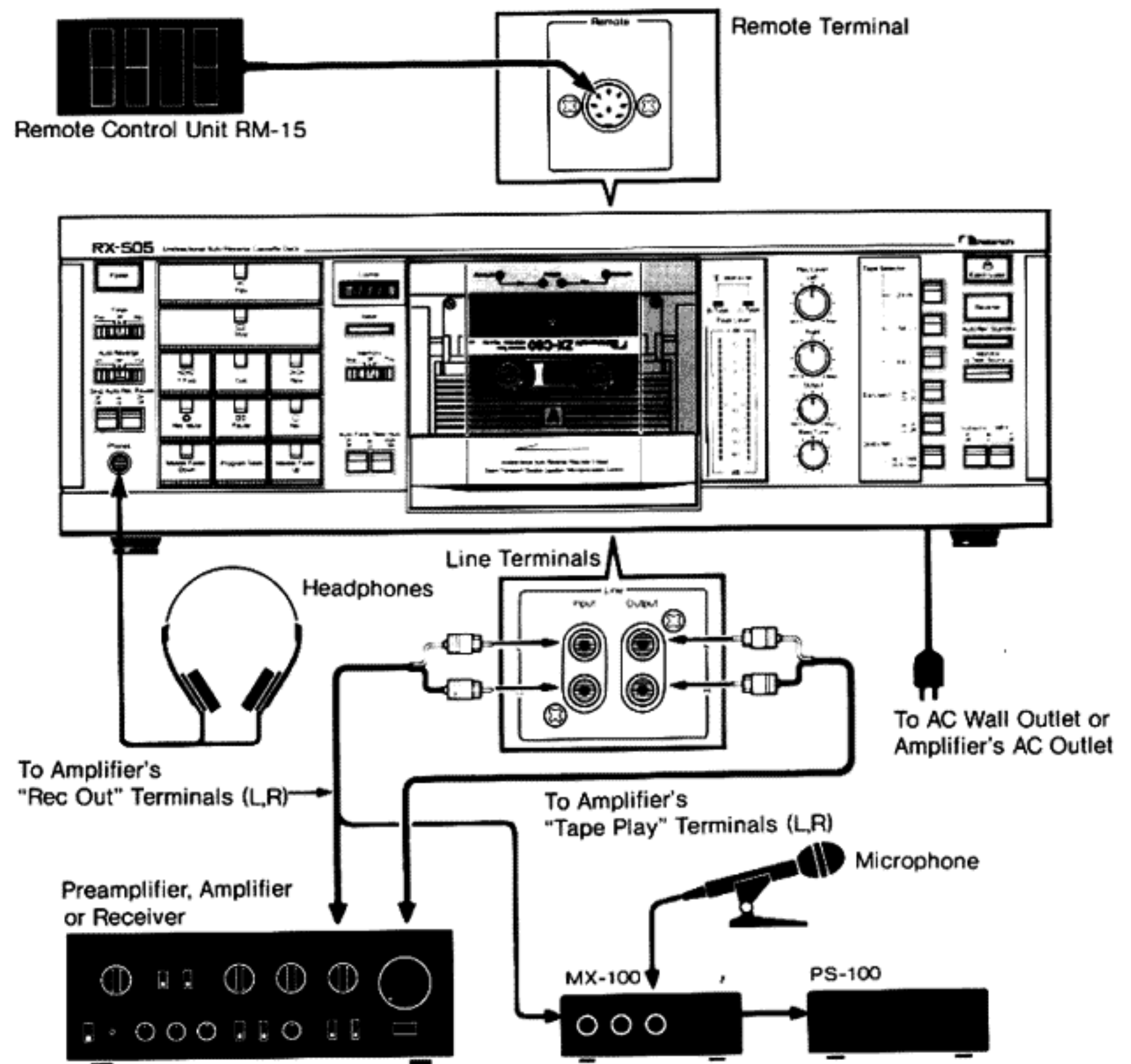

Precautions Before Operation

1. This deck incorporates a muting circuit which is active for about 7 seconds after the power was switched on, until all circuits have become stable. During the muting interval, the Stop button indicator flashes and tape transport operation is not possible. However, the Eject/Load button and the Reverse button can be operated.
2. If the power is switched on while the Timer switch is set to "Rec" or "Play", recording or playback will start automatically. To prevent accidental erasure of a tape, be sure to set the Timer switch to "Off" when the timer function is not desired.
3. If the reverse operation cannot be performed due to an obstacle in front of the cassette deck, the cassette compartment

will return to its initial position. The cassette compartment may also be opened manually while the power is off. In this case, pull the base section out approximately 2 or 3 seconds after the power was switched off. When the compartment is pulled out completely, the lock engages. To reset the cassette, the power must be switched on and the Eject/Load button pushed. Be careful not to exert excessive force on the cassette compartment cover.

4. This deck incorporates a special circuit designed to take up any loose tape inside the cassette. When a cassette is set and the cassette compartment closed and also when the power is switched on, the

left-hand spindle will rotate slightly and the tape counter indication may change. This behavior is normal and not a fault with the deck.

5. Voltage Selector

AC voltage is factory-set for the country in which you purchased your cassette deck. The voltage selector permits re-setting of mains voltage in case the deck is to be used in a different country.

Note:

Safety regulations in certain countries prohibit inclusion of a voltage selector. This feature, therefore, may be absent from your deck.

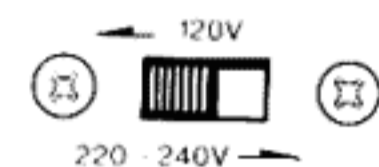

Operation • Insert a cassette, referring to "Cassette Insertion and Removal" on page 3.

Playback

- (1) Set the Equalizer switch to the required position for the tape in use.
- (2) Set the Dolby NR switches to the same position as used for recording.
- (3) Press the Play button to start playback. When the Play button is pressed in the eject condition, the cassette is automatically drawn in, set at side A, and playback starts.
- (4) Adjust the desired listening level with the Output Level control.
 - With this deck you can go from any mode into any other (for example from playback to rewind, from rewind to fast-forward, etc. without having to press the Stop button.)
 - During playback, this deck's Peak Level meters display the level recorded on the tape. Readings are not affected by turning the Output Level control.

Recording

- (1) Set the Tape Selector switches and the Equalizer switch to the required positions for the tape in use.
- (2) Select the desired position of the Dolby NR switches. For recording from FM broadcasts, set the MPX Filter switch to "On". For recording from phonograph records, set the Subsonic Filter switch to "On".
- (3) To put the deck into the record-standby mode, push the Pause button while keeping the Record button depressed.
- (4) Set the Monitor switch to "Source" and adjust the recording level with the Rec Level controls while watching the indication of the Peak Level meters.
- (5) Press the Play button to start recording.
- (6) To check the quality of the recording in progress, you can monitor the playback signal by setting the Monitor switch to "Tape". In the "Source" position, the input signal before recording is heard. For short-term interruption of recording,

press the Pause button to set the deck to the record-standby mode. To resume recording, press the Play button.

Note:

- Be careful not to press the Eject/Load button by mistake during recording, as this will result in the recording being interrupted and the tape being ejected.

Record Level Setting

For good recordings, it is essential to maintain a high signal-to-noise ratio. If the record level is set too low, tape hiss will impair the playback sound quality. If it is set too high, the tape will be driven into distortion. Refer to the chart below to set recording levels.

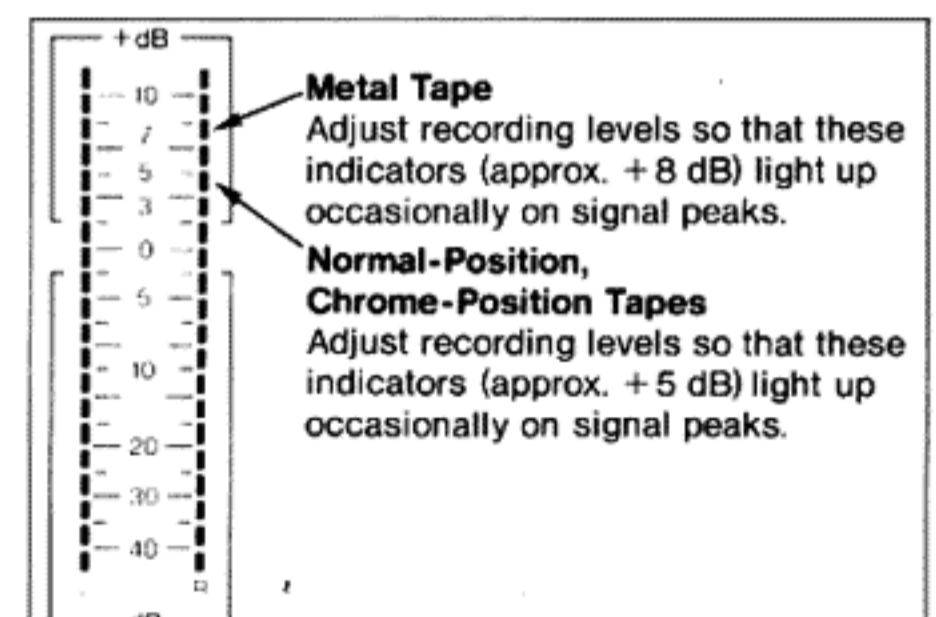

The above values should be used as a general guideline. Actual requirements may vary to a certain degree, depending on the tape in use and the recording source.

Dolby NR System

This cassette deck provides a choice between the Dolby B-type and the Dolby C-type noise reduction systems. The Dolby B-type NR provides approximately 10 dB of noise reduction in the high frequencies. The Dolby C-type NR is a further refined system, which achieves a S/N ratio improvement of about

20 dB in the range from 2 kHz to 8 kHz, where noise is most readily audible. For playback of a tape which was recorded with the B-type NR, set the Dolby NR switch to "B". For playback of a tape recorded with Dolby C-type NR, set the switch to "C".

■ Timer Recording or Playback

- (1) Establish connections as shown in the chart, and switch on the power to all components.
- (2) For timer-activated recording, set the recording level to suit the expected signal. For timer-activated playback, set the Output control to the desired level.
- (3) For timer-activated recording, set this deck's Timer switch to "Rec". For timer-activated playback, set the switch to "Play".
- (4) Set the timer to the desired operation time.
- (5) At the pre-selected time, the timer will supply power to the components, and recording or playback will start automatically.

Notes:

- Be sure to set this deck's Timer switch to "Off" when timer recording or playback is not to be carried out.
- If the record-protection tabs of the inserted cassette are removed, timer-activated recording is not possible and the deck will go into the stop mode.
- If the power to the deck is cut off while the cassette is being rotated, the cassette compartment will remain in the eject condition when the power is switched on again. If consecutive recording is to be carried out with a timer, set the timer so that power will not be switched off while the cassette is being rotated.

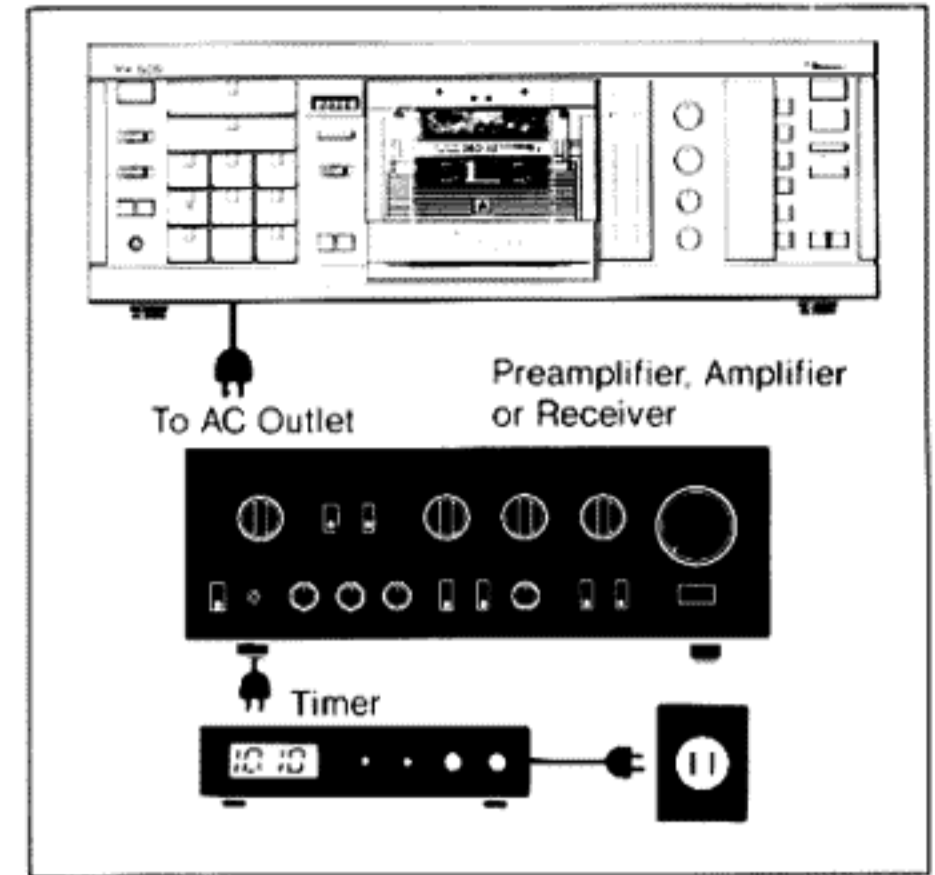



The Auto-Reverse System

[Auto-Reverse Operation Using the Reverse Mode Switch]

When the Reverse Mode switch (marked "Auto Reverse") is set to "Off", the auto-reverse system is inactive and the RX-505 operates as an ordinary cassette deck with automatic stop at the tape end after playback or recording of one side.





(1) Auto-Reverse Playback

When the Reverse Mode switch is set to , side B is played back automatically after side A is terminated. At the end of side B, the tape stops.

If the switch is set to , sides A and B are played back in endless succession.

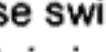
When the tape end is reached in fast-forward or playback, the cassette is automatically reversed, then the tape is forwarded for the leader tape section, and playback starts at the beginning of the other side.

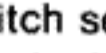
(2) Auto-Reverse Recording

When the Auto Reverse switch is set to  or  and the deck is in the record mode, auto-reverse recording will be carried out, in the order of side A  side B. At the end of side B, the tape stops automatically. Even with the Reverse mode switch set to , auto-reverse recording in the order of side B  side A is not possible.

- If the record-protection tabs of side B are removed, tape run of side B will be in the playback mode.

[Operation of the Reverse Button]

When the Reverse button is pressed in the stop mode, the cassette is reversed and loaded again. When the button is pressed in the

record, playback or pause mode, the cassette is reversed and the deck goes again into the respective mode.

- For protection of the tape mechanism, the Reverse button is inoperative during fast-forward and rewind.
- If the Reverse button is pressed again during the reverse operation, the cassette is reversed once more, but regardless of the previous mode, the tape will be in the stop mode. Therefore, if the Reverse button was pressed by mistake, pressing it immediately once more causes it to operate as a stop button.

Skip Function

When the Skip switch is set to "On", a blank section (recording level below -30 dB) of more than 40 seconds duration during playback will cause the tape to be fast-forwarded to the end of the side. In combination with the Reverse Mode switch, this feature is also useful for swift cassette reversal at the tape end after the recorded section of one side is terminated.

- If a musical selection contains a very low-level recorded section (less than -30 dB) of more than 40 seconds, the skip function may be triggered even during playback of this selection.

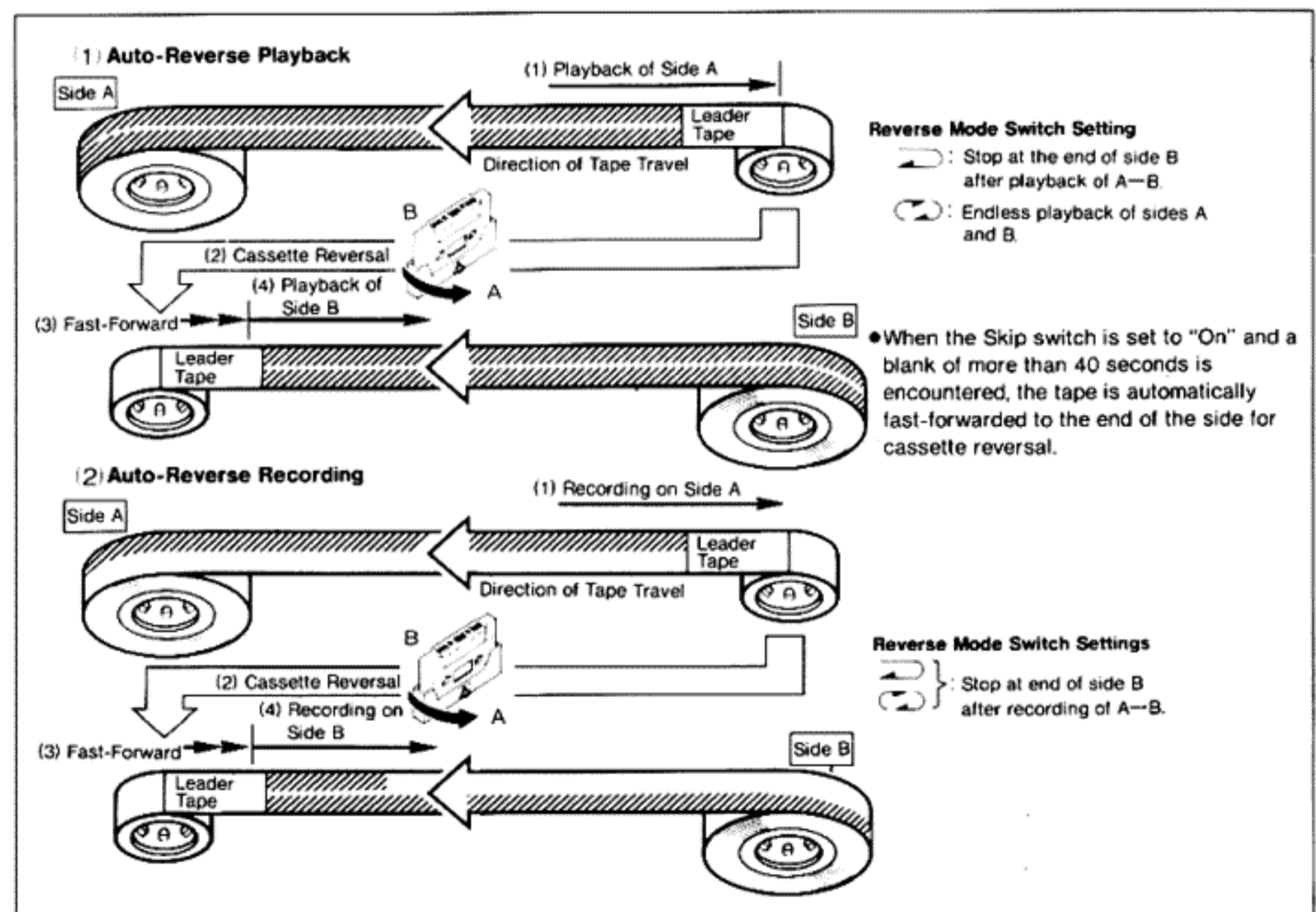

Special Features

Auto Rec Standby

The Auto Rec Standby button has two different functions, depending on whether it is pressed once or twice.

(1) Press the button **once** if you are at some point on a tape and you want to start recording again from the beginning of the same side (for example to recommence a recording which has not turned out as planned, etc.). The deck automatically performs the following operating sequence: **rewind to the beginning of the side** ⇨ **fast-forward for the portion of the leader tape** ⇨ **6 seconds tape run in Rec Mute condition** ⇨ **record-standby mode**. (During this operation, the Record indicator flashes.)

This feature is also handy with a tape which is already rewound to the beginning. Pressing the button will result in the following sequence: **fast-forward for the portion of the leader tape** ⇨ **6 seconds tape run in Rec Mute condition** ⇨ **record-standby mode**.

(2) Press the button **twice** in short succession (within 0.5 seconds) if you are at some point of side A, but want to start recording from side B. The deck automatically performs the following operating sequence: **fast-forward to the end of side A** ⇨ **cassette reversal** ⇨ **fast-forward for the portion of the leader tape** ⇨ **6 seconds tape run in Rec Mute condition** ⇨

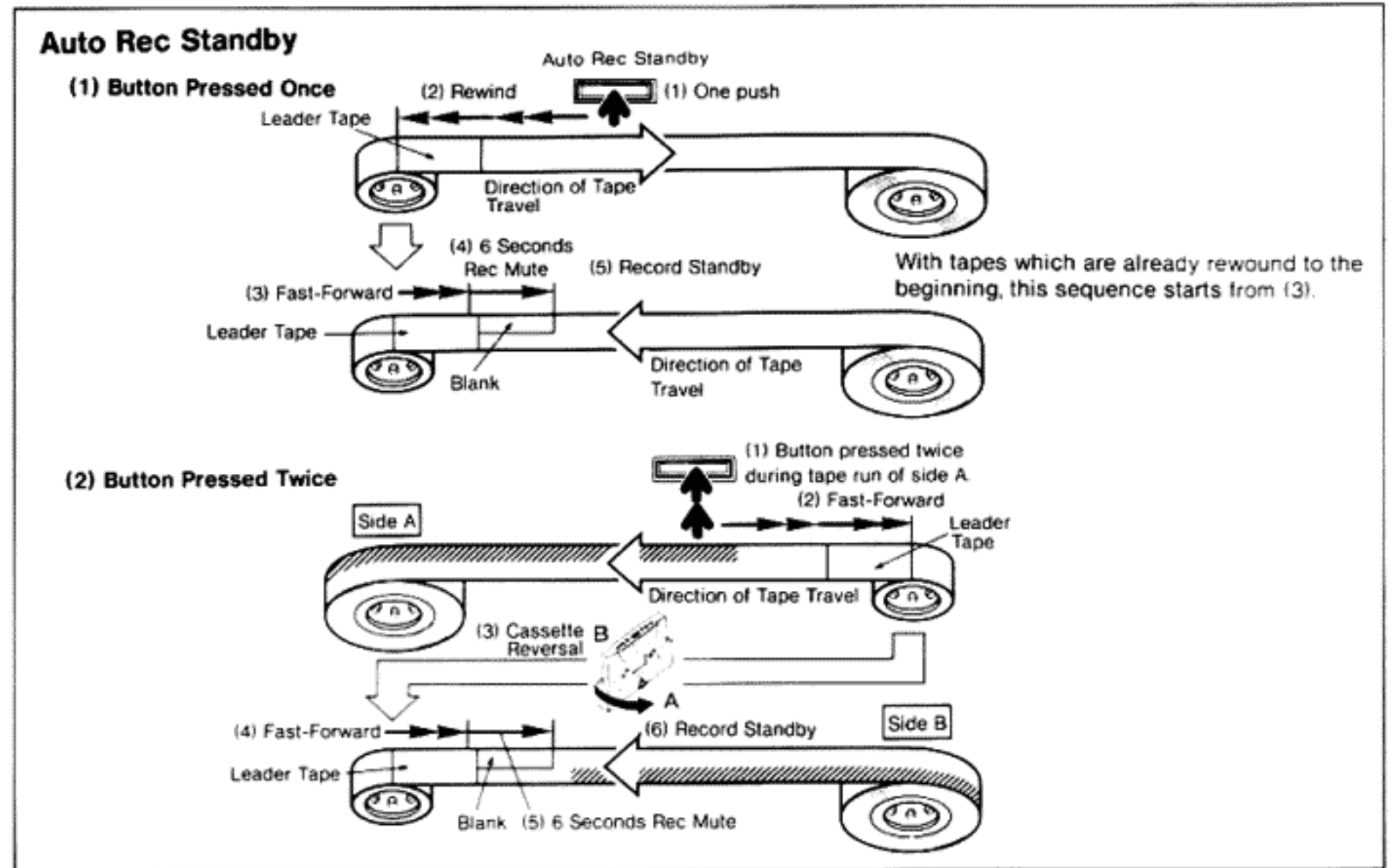

record-standby mode. (During this operation, the Record indicator flashes.)



- This operating sequence can be performed also with the Reverse Mode switch set to "Off".
- If you are at some point of side B, the operation described in (2) is not possible, and the operating sequence of (1) only will result.

- If the Auto Rec Standby button was pressed by mistake, the operation can be cancelled by pressing the Stop button.
- During fast-forward or rewind, the Auto Rec Standby button is inactive.
- If the record-protection tabs of a cassette are removed, the tape will stop after being forwarded for the leader tape section.

Auto Fade

By using this feature for auto-reverse recording/playback, a smooth transition from side A to side B can be achieved.

(1) Use for Auto-Reverse Recording/Playback

When the Reverse Mode switch is set to  or  and auto-reverse recording is performed, setting the Auto Fade switch to "On" will cause the following operating sequence to be carried out from a point approximately 20 seconds before the leader tape at the end of side A (this point is detected automatically by the deck): **automatic fade-out within 2 seconds** ⇨ **cassette reversal to side B** ⇨ **fade-in within 2 seconds** ⇨ **ordinary recording**.

At the end of side B, automatic fade-out is performed approximately 20 seconds before the leader tape, and then the recording is terminated.

Fade function, setting the Reverse Mode Switch to  and the Auto Fade switch to "On" will cause the cassette to be reversed at

the same point as in recording, resulting in a swifter transition between sides for unmarred music playback.

Note:

- For ordinary tape playback, the Auto Fade switch should be set to "Off".

(2) Use For Recording of One Side

If the Auto Fade switch is set to "On" while performing ordinary one-side recording (Reverse Mode switch set to "Off"), automatic fade-out will be performed at a point approximately 20 seconds before the leader tape at the end of the side, and the recording will be terminated.

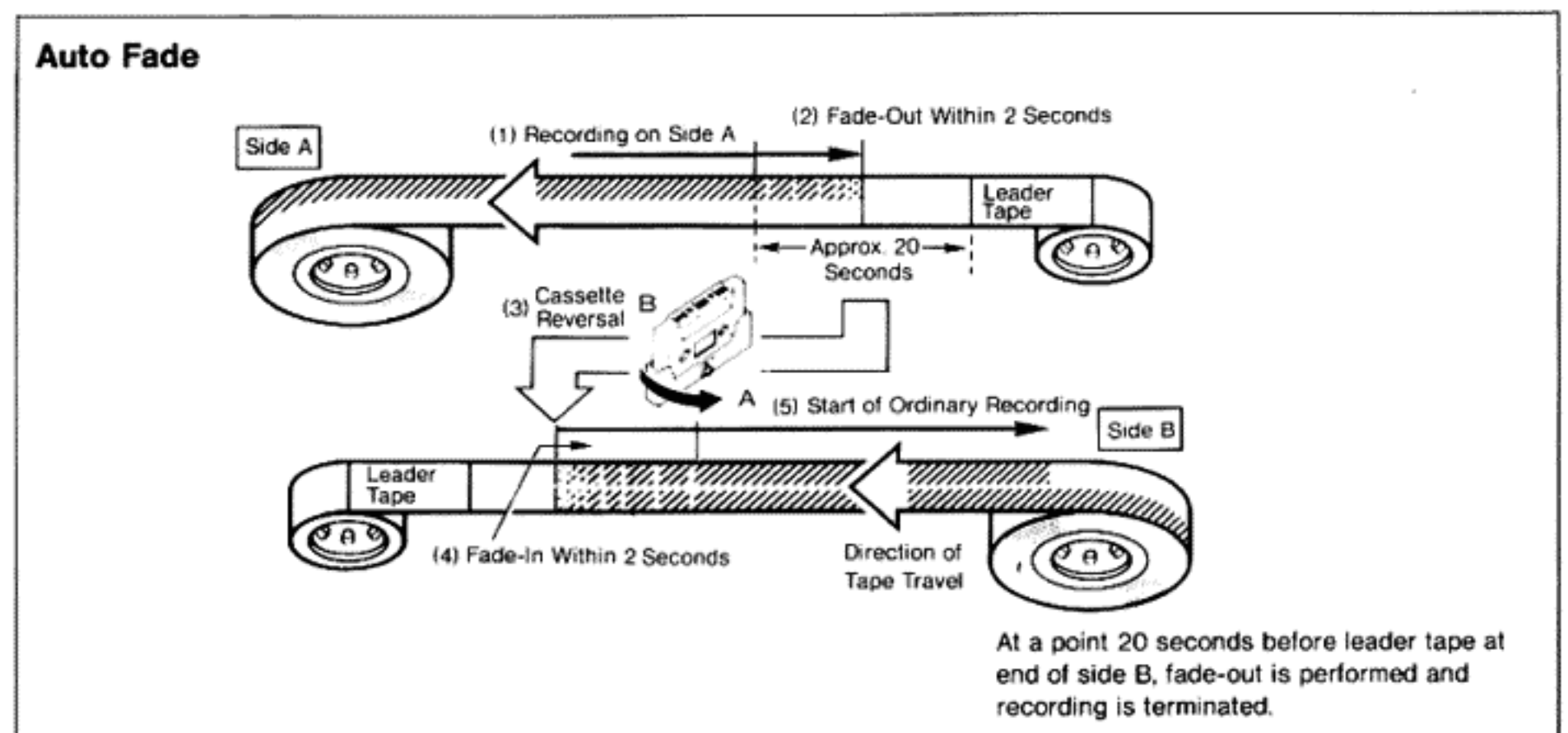

Reel Hub Switch

When using the Auto Fade function for recording or playback, the Reel Hub switch must be set to "Large" (for cassettes with large hub diameter) or "Std" (for cassettes with standard-size hubs). If the Reel Hub switch setting is inappropriate, correct detection of the auto-fade point is not possible.

Cassette with a playing time of one hour or more (C-60, C-90 etc.) have standard-size hubs and the required switch setting for such cassettes is "Std". Cassettes with a shorter playing time (C-46 etc.) may have large hubs, as do for example the C-46 types of Nakamichi's EXII, SX, SXII, and ZX tape. For these cassettes, the switch must be set to "Large".

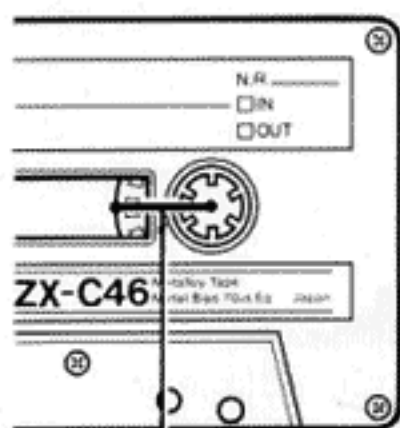

Large-Hub Cassette
Reel Hub Radius 15 mm

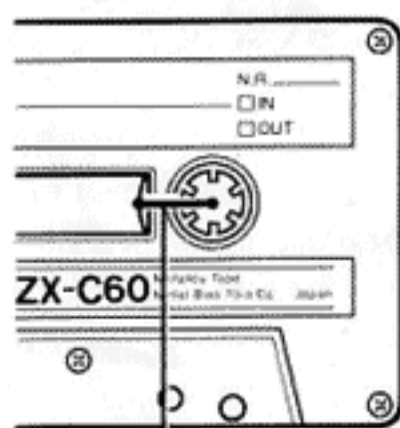

Standard-Hub Cassette
Reel Hub Radius 11 mm

Program Seek

This feature operates by detecting blank sections (recorded level below -30 dB) of more than 4 seconds between selections and automatically starts playback from this point. It can be used to locate the next and the previous selection.

(1) Program Seek of the Next Selection

If the Program Seek button is pressed in the stop, playback, fast-forward, pause or cueing mode, the following operating sequence is performed: **fast-forward** → **detection of the start of the next selection** → **rewind for a small interval** → **playback from the beginning of the selection**. During this operation, the indicator of the Fast-Forward button lights up and the Play button indicator flashes.

If the Program Seek button is pushed once more after the start of the Program Seek operation, the next selection is skipped and **playback starts from the beginning of the second selection**. In this case, the Play button indicator first flashes in longer intervals and resumes the normal blinking cycle after the beginning of the first selection has been passed by.

(2) Program Seek of Previous Selection

If the Program Seek button is pressed in the rewind mode, the beginning of the present selection is located in rewind, and playback starts automatically from this point. During this operation, the indicator of the Rewind button lights up and the Play button indicator flashes. If the Program Seek button is pushed once more after the start of the Program Seek operation, the beginning of one section earlier is located and playback starts from there. In this case, the Play button indicator first flashes in longer intervals and resumes the normal blinking cycle after the beginning of the first selection has been passed by.

- If the Program Seek button is pushed at a point between two selections and there are more than 4 seconds until the beginning of the next selection, this blank is detected and playback starts from there.
- If the section between two selections contains record scratch noise etc. or the blank is less than 4 seconds long, the start of a selection may not be located correctly.
- During the Program Seek operation, the use of the cueing function is not possible.

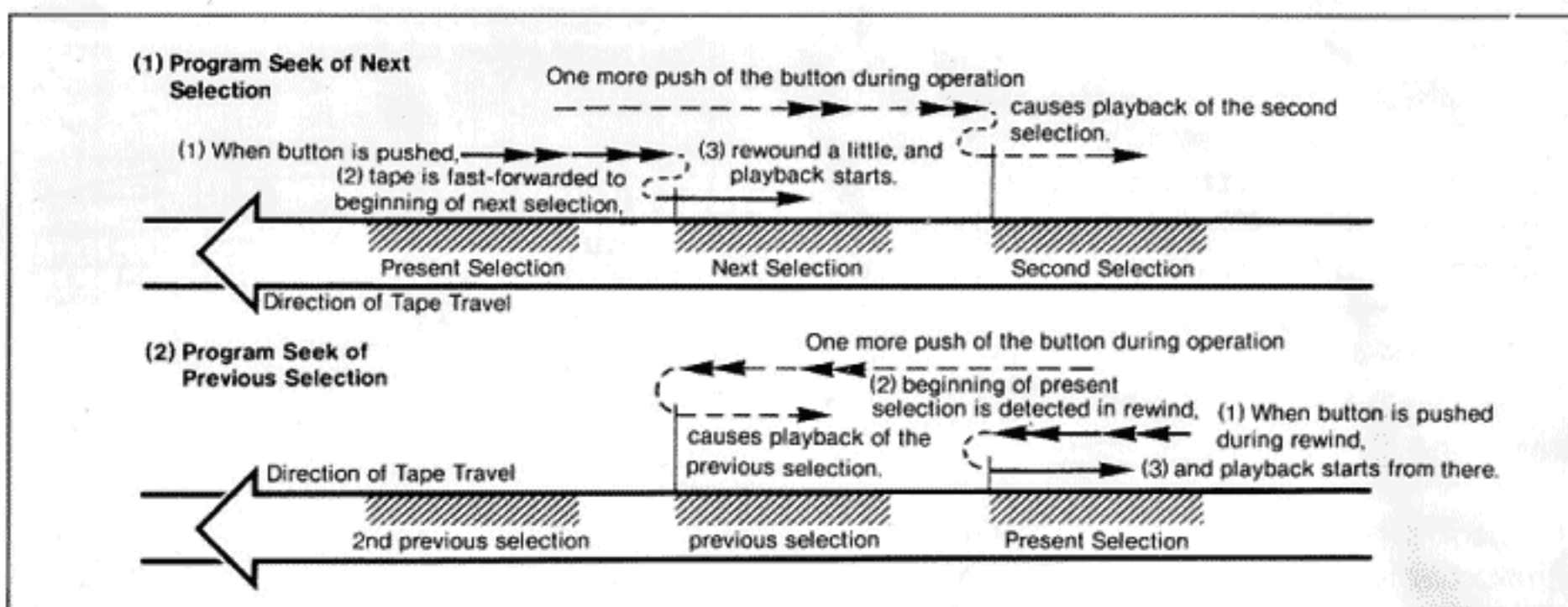

Auto Rec Pause

If the Auto Rec Pause switch is set to "On", a no-signal condition during recording (recording level below -30 dB) of more than 45 seconds will cause the tape to be rewound for the equivalent of 30 seconds, and then the deck enters the record-standby mode. Thus 15 seconds after the recording signal stopped, the deck automatically goes into standby, which prevents unnecessary tape overrun and eliminates the need to rewind the tape and search for the end location of a recording. To re-start recording, press the Play button.

- If recording is performed at a very low level (below -30 dB) for more than 45 seconds, the Auto Rec Pause function may be triggered even during a musical selection.
- The Auto Rec Pause function is triggered also if recording is carried out in the Master Fader "Down" condition or the Rec Mute button is kept depressed for more than 45 seconds.

Cueing

If the Cueing button is pressed during fast-forward or rewind, the winding speed is reduced to one-third and the recorded signals from the tape can be heard. When you approach the desired spot on the tape, you can further reduce winding speed to one-sixth by pressing and holding the Fast-Forward or Rewind button. If you have moved the tape too far in one direction, you can change the direction of tape travel while remaining in the cueing mode simply by pressing the opposite fast-winding button. Pressing both fast-winding buttons simultaneously will stop the tape with the deck remaining in the cueing mode, and releasing both buttons simultaneously causes the deck to enter the pause mode. In this way, any desired spot on the tape can be easily located.

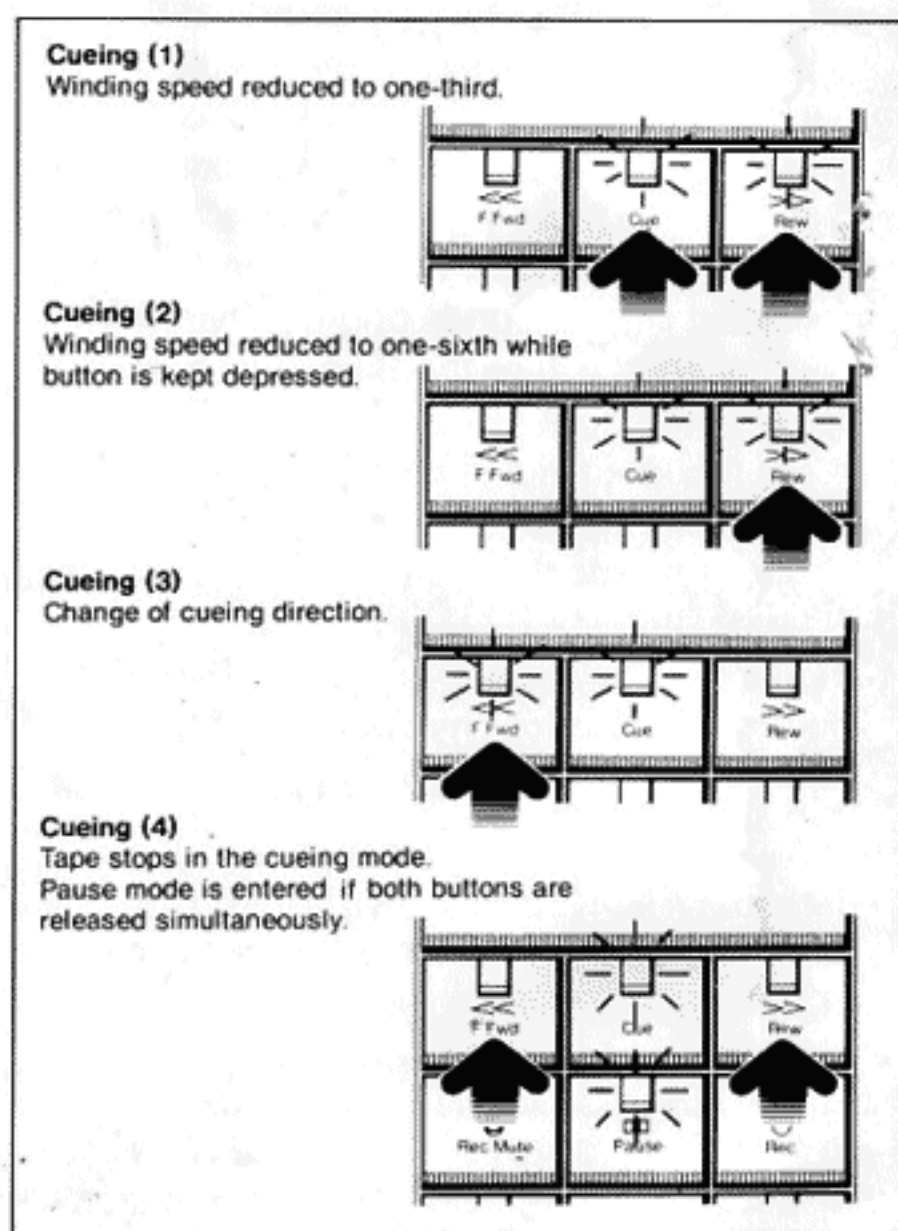

Master Fader

By pressing the "Down" button of the Master Fader, fade-out (gradual level decrease to zero) can be performed automatically during recording. After having decreased the level by pressing "Down", fade-in (gradual level increase up to the previous setting) can be performed automatically by pressing the "Up" button.

You can choose between two fading speeds. If you press the button strongly (so that the switch clicks twice) and keep it depressed, the fading is comparatively fast. If you press the button lightly (only one click) and keep it depressed, or press the button once and release it immediately, the fading is slower. The fading status is indicated by the brightness of the indicators. The respective fading mode is indicated by the brightness of the indicators.

- The operation of the Master Fader can be changed from "Up" to "Down" or from "Down" to "Up", but it cannot be stopped midway.
- The Master Fader is operative only in the record and record-standby modes. When these modes are released, the setting automatically becomes "Up".

Rec Mute

When the Rec Mute button is pressed during recording, a blank portion is recorded on the tape for as long as the button is kept depressed. If the Monitor switch is set to "Source", the line and headphone outputs are not muted so that it is possible to continuously monitor the input signal.

Punch-In Recording

When during playback the Record button is pushed while keeping the Play button depressed, the deck smoothly enters the record mode without tape travel being interrupted. This is useful for example to insert narration on blank sections left between selections in a previous recording, etc. If the deck is in the pause mode and the Record button is pushed while keeping the Pause button depressed, the Record button indicator flashes for about 2 seconds and then the record-standby mode is entered.

Bias Tune Control

This deck provides a bias tune control which permits fine adjustment of the bias current after the standard values have been set with the tape selector switches.

When using tapes from the list, the Bias Tune control should be left in the center click-stop position. When using other tapes, adjust the control so that the tonal difference between the input signal ("Source") and the recorded signal ("Tape") is reduced to a minimum.

- (1) Compare the input signal ("Source") with the recorded signal ("Tape"). If the recorded signal sounds brighter than the original source, turn the Bias Tune control towards the right (+).
- (2) If the recorded signal sounds duller than the original source, turn the Bias Tune control towards the left (-).
- (3) By repeating steps (1) and (2) and monitoring the results, adjust the Bias Tune control to minimize any sound quality differences.

Maintenance

Cleaning

It is very important to regularly clean the head surfaces and transport section, etc. Contamination caused by tiny particles shedded from the tape onto these parts can become the cause of drop-outs and severely degrade high-frequency response and wow-and-flutter characteristics. Perform cleaning as follows.

- (1) Remove the cassette compartment cover in the eject condition, and then press the Eject/Load button to slide the cassette compartment in.
- (2) Press the Play button and clean the revolving pressure rollers by holding a cotton-tipped stick lightly against the roller on the side turning away from the capstan. Be careful that the cotton tip does not get caught between the roller and the capstan.
- (3) Press the Pause button to release the pressure rollers from the capstans. Now clean the capstans and the surfaces of the heads and tape guide with a cotton-tipped stick. Be careful not to apply too much force. Take special care not damage the tape guide and the tape pad lifter.
 - After cleaning, make sure that no cotton strands are left on any of the cleaned parts.
 - In case of severe contamination, moisten the cotton tip with a small amount of commercially available cleaning fluid especially designed for this purpose. After cleaning, wait until any residue has completely dried off before playing a tape.

Be careful not to exert excessive pressure on the cassette compartment cover.

• **Removal of Cassette Compartment Cover**
While steadying the base section of the cassette compartment with the middle finger, grip the cover between thumb and index finger and push it in the direction indicated by the arrows. The snap lock is released and the cover can be removed.

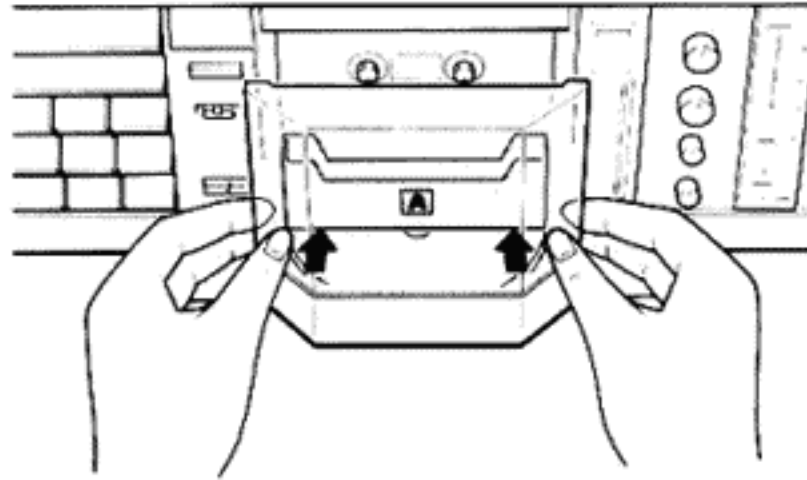

• **Reattachment of Cassette Compartment Cover**
Support the cassette compartment with your thumb. Press the cover down with the index finger while pulling it towards you with the middle finger to engage the snap lock.

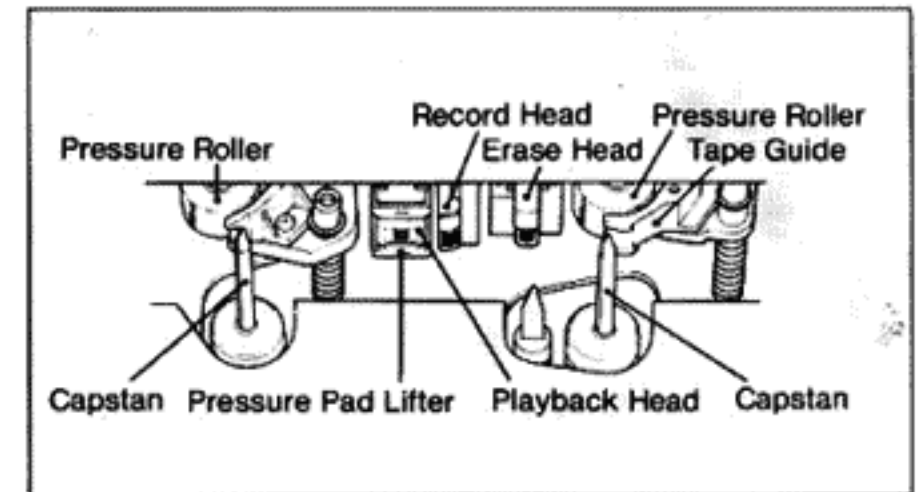
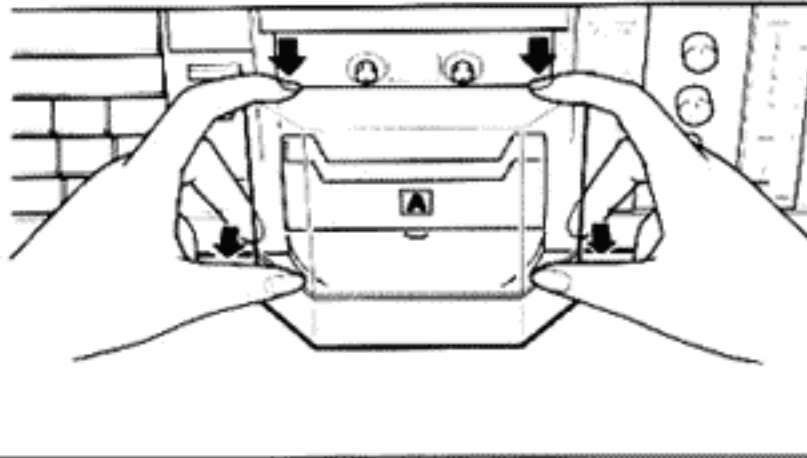

Demagnetizing

After a longer period of use, there can be a build-up of residual magnetism in the heads and capstans. Such residual magnetism can induce noise and partially erase the high frequencies of a tape being played. To prevent this, you should demagnetize these parts about once every 50 hours of use with the Nakamichi DM-10 Demagnetizer (optional) or any other properly designed demagnetizer. For details, refer to the instruction manual of the demagnetizer.

Lubrication

All important moving parts of this cassette deck are fitted with long-life, oil-less bearings.

Cleaning the Faceplate

Clean the faceplate only with the supplied polishing cloth. Never use alcohol, solvents, ammonia or abrasive cleaning agents.

Troubleshooting

Condition	Probable Cause	Remedy
Record mode cannot be entered.	1. Cassette tabs have been removed.	1. Place adhesive tape over tab opening or use new cassette.
Excessive playback hiss.	2. Head is magnetized.	2. Demagnetize head.
Uneven sound levels, drop-outs, excessive wow/flutter.	3. Heads and/or capstans and pressure rollers dirty. 4. Faulty cassette.	3. Clean these parts. 4. Replace cassette.
Incomplete erasure.	5. Erase head dirty.	5. Clean head and pressure rollers.
Distorted record/playback sound.	6. Program material itself is distorted. 7. Recording levels are too high. 8. Heads dirty. 9. Wrong setting of tape selector switches.	6. Check program material. 7. Wide dynamic range permits some short-term overload, but excessive recording levels will cause distortion. Adjust recording levels. 8. Clean heads. 9. Select correct setting for the tape in use.
Record mode is entered, but cannot record.	10. Input disconnected. 11. Head dirty.	10. Check connections. 11. Clean head.

(cont. on next page)

Troubleshooting (cont. from previous page)

Condition	Probable Cause	Remedy
Cannot playback.	12. Output disconnected. 13. Head dirty.	12. Check connections. 13. Clean head.
Dull high frequencies.	14. Heads dirty. 15. Tape selector switches and/or equalizer switch not set correctly.	14. Clean heads. 15. Select correct positions for tape in use.
Hum heard during recording or playback.	16. Strong induction fields near deck. 17. Signal cable or connector grounding faulty.	16. Keep deck away from amplifier, transformers, fluorescent lamps, etc. 17. Replace signal cables.

Specifications

Track Configuration	4 tracks/2-channel stereo (auto-reverse recording and playback)
Heads	3 (erase head x 1, record head x 1, playback head x 1)
Motors (Tape Transport)	PLL servo motor (capstan drive) x 1 DC motor (reel drive) x 1
Power Source	100, 120, 120/220-240, 220 or 240 V AC, 50/60 Hz (According to country of sale)
Power Consumption	33W max.
Tape Speed	1-7/8 ips. (4.8 cm/sec.)
Wow-and-Flutter	Less than 0.04% WTD RMS Less than ± 0.08% WTD Peak
Frequency Response	20 Hz — 20,000 Hz ± 3 dB (recording level — 20 dB, ZX, SX, EXII tape)
Signal-to-Noise Ratio	Dolby C-Type NR on < 70 μs, ZX tape > Better than 70 dB (400 Hz, 3% THD, IHF A-WTD RMS) Dolby B-Type NR on < 70 μs, ZX tape > Better than 64 dB (400 Hz, 3% THD, IHF A-WTD RMS)
Total Harmonic Distortion	Less than 0.9% (400 Hz, 0 dB, ZX tape) Less than 1.0% (400 Hz, 0 dB, SX, EXII tape)
Erasure	Better than 60 dB (100 Hz, +10 dB)
Separation	Better than 36 dB (1 kHz, 0 dB)

Crosstalk	Better than 60 dB (1 kHz, 0 dB)
Bias Frequency	105 kHz
Input (Line)	50 mV/70 kohms
Output (Line)	1.0 V (400 Hz, 0 dB, output level control at max.) 2.2 kohms
(Headphones)	12 mW (400 Hz, 0 dB, output level control at max.) 8 ohms load
Fast-Winding Time	Approx. 60 seconds (with C-60 cassette)
Dimensions	450 (W) x 144 (H) x 300 (D) millimetres 17-3/4 (W) x 5-11/16 (H) x 11-13/16 (D) inches
Approximate Weight	10 kg 22 lbs. 1 oz.

- Specification and appearance design are subject to change for further improvement without notice.
- Noise Reduction System manufactured under license from Dolby Laboratories Licensing Corporation.
- The Word "DOLBY" and the Double-D-Symbol are trademarks of Dolby Laboratories Licensing Corporation.

Optional Accessories

ZX Metalloy Cassette Tape
C-60, C-90
SX II Super Ferricobalt Cassette Tape
C-60, C-90
SX Ferricobalt Cassette Tape
C-60, C-90
EX II Ferricrystal Cassette Tape
C-60, C-90

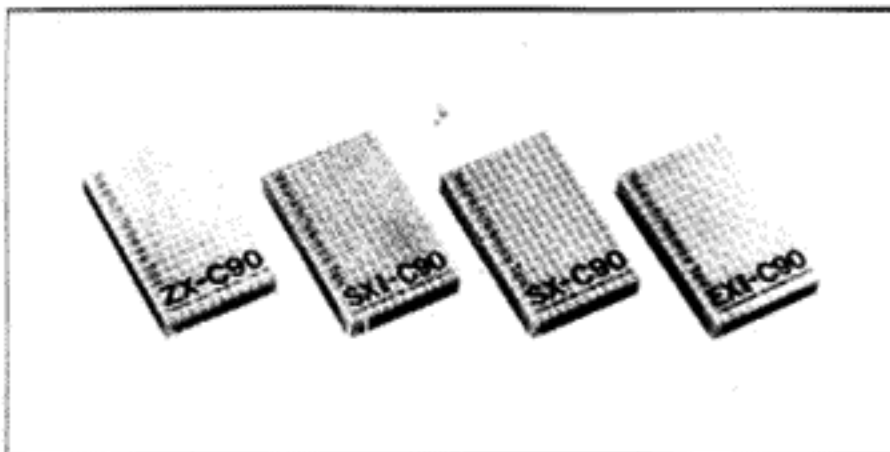

RM-15 Remote Control Unit

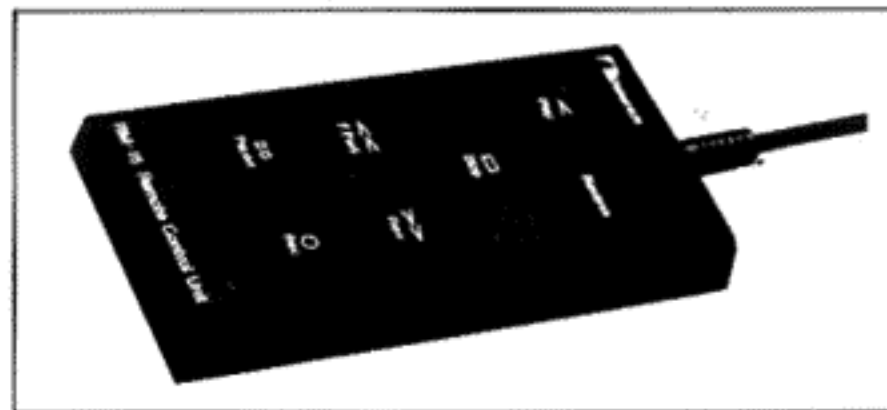

DM-10 Head Demagnetizer

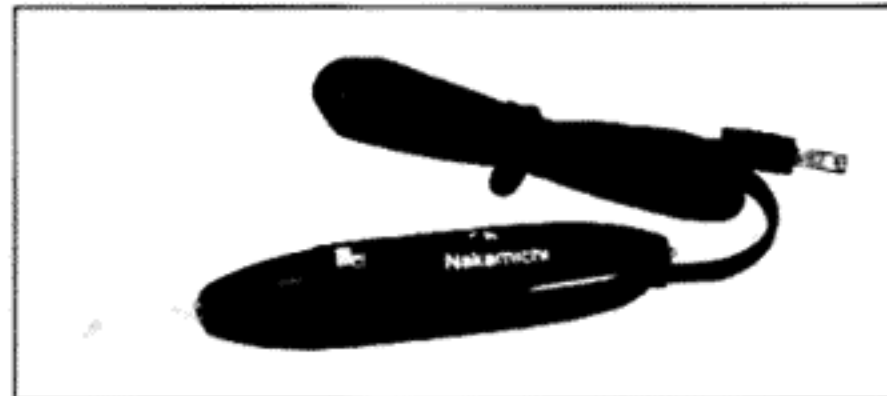

SP-7 Stereo Headphones



Nakamichi Corporation/Tokyo Office
Nakamichi America Corporation
Nakamichi Canada
Nakamichi GmbH
Nakamichi Australia

Shinjuku Daiichi Seimei Bldg., 2-7-1 Nishishinjuku, Shinjuku-ku, Tokyo 163 Phone: (03) 342-4461 Telex: 2324721 (NAKAM J)
19701 South Vermont Ave., Torrance, CA 90502 Phone: (213) 538-8150
276 South West, Marine Drive, Vancouver, B.C. V5X 2R4 Phone: (604) 324-7535
Praunheimer Landstraße 32, 6000 Frankfurt Main 90 Phone: (069) 7682021
Unit 10, 21-29 Chester Street, Camperdown, N.S.W. 2050 Phone: (02) 519-3977