



Nakamichi DRAGON

Auto Reverse Cassette Deck

Nakamichi **DRAGON** Auto Reverse Cassette Deck



NACC

Ultrasonic 3-Head / Dual In Direct Drive Capstan / Silent Mechanism / Microprocessor Control



Reset
Memory Off / On
Auto Rev Off / On
D/S



—DRAGON— The Most Incredible Creature Of The Decade !

Only once or twice a decade does a truly remarkable "breakthrough" occur in cassette-recording technology — not a mere refinement of past technique but a dramatic advance in engineering knowledge that solves a basic technological problem and opens the door to the future. One such "breakthrough" was the development of Dolby-B noise-reduction — the first viable consumer NR system — the one that suppressed tape hiss without introducing audible coloration. With Dolby-B NR, high-fidelity cassette reproduction became a possibility. Another "breakthrough" occurred when Nakamichi created the Model 1000 — the world's first three-head cassette deck — the one that made high-fidelity cassette reproduction a *reality!*



Steady progress has been made "refining" these "breakthroughs." Dolby-B NR led to the C-type system, and hiss was banished to the point of inaudibility. With new tapes, it became possible to extend response beyond 20 kHz, and we developed the advanced magnetic heads and electronics to do so. We refined the dual-capstan drive and ultimately created the Asymmetrical Diffused-Resonance transport that eliminated common-mode resonance and controlled tape tension so precisely that it required no pressure pad. Mechanical "logic" gave way to "IC logic" and then to full microprocessor control. Finally, we developed the SLT motor that eliminated "belt wow" without introducing "direct-drive flutter."

It seemed as if cassette recording had advanced to its limit, but one problem remained — a basic one that limits cassette interchangeability and precludes "reverse playback" with full fidelity — play-head azimuth misalignment! True, we had developed a system to ensure proper *recording* azimuth, but it cannot correct a tape that has *already* been recorded improperly or one that tracks slightly askew in reverse. Such correction must occur *on playback*, and that was considered impossible! No longer! In DRAGON, we introduce NAAC — Nakamichi Auto Azimuth Correction — the most revolutionary "breakthrough" of the decade — an automatic *playback* azimuth-correction system that brings forth the full spectrum recorded on cassette!



NAAC Reveals The Hidden Highs Of Each Cassette

Azimuth misalignment between record and play-head gaps severely restricts high-frequency response. As Figure 1 shows, a disagreement between the angle at which a tape was recorded and the angle at which it is played has an effect very similar to that of widening the playback gap. When this happens, the play head is unable to "resolve" short wavelengths and high-frequency response drops precipitously as shown in Figure 2. The music sounds dull and lacks the crispness and clarity that give it life *even though the tape may contain the full range of frequencies that originally were recorded!*

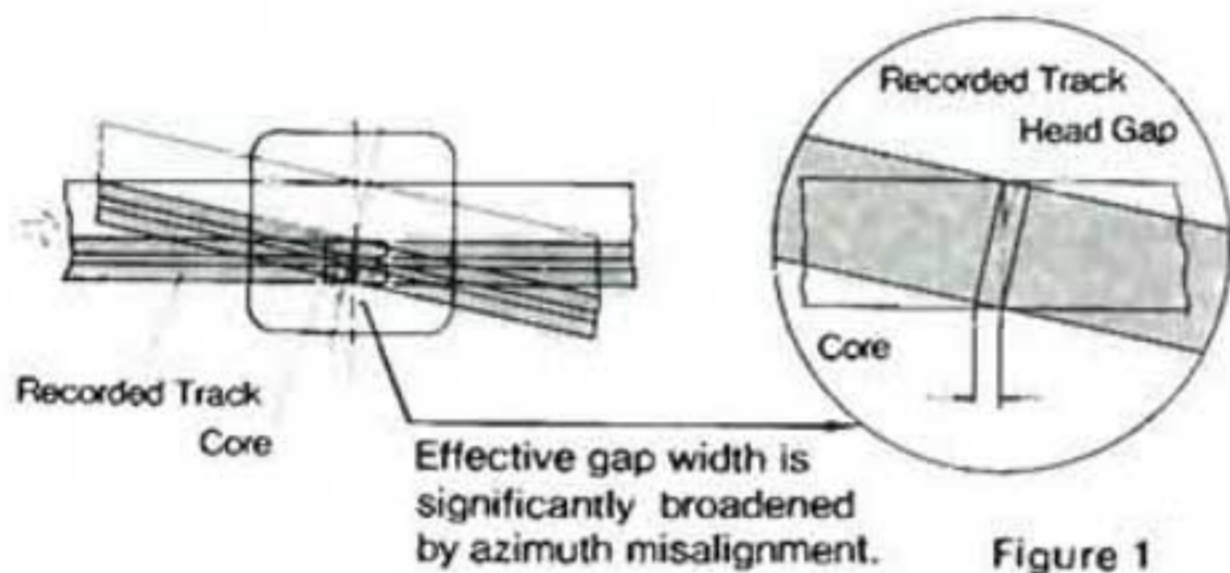

Azimuth disagreement can happen for several reasons, the most obvious being physically misaligned heads. But even heads that were properly aligned at the factory will not guarantee perfect reproduction. Tape-width and cassette-shell tolerances, together with differences in tape tension from deck to deck, cause the tape to track along a slightly different path in each cassette and in each machine. Thus, a tape recorded on one deck will not necessarily reveal its full response when played on another, and, when a tape is recorded in one direction and reproduced in the opposite direction — as, for example, on an auto-reverse deck — there is almost bound to be considerable azimuth disagreement.

Even the slightest misalignment — one measured not in "degrees," but in "minutes" of arc (sixtieth parts of a degree!) — causes a very audible loss in treble response. To make matters worse, noise-reduction systems increase whatever loss exists in the basic record/play response. Without doubt, azimuth misalignment is the prime reason why, in the past, cassettes have usually sounded best when played on the deck that recorded them.

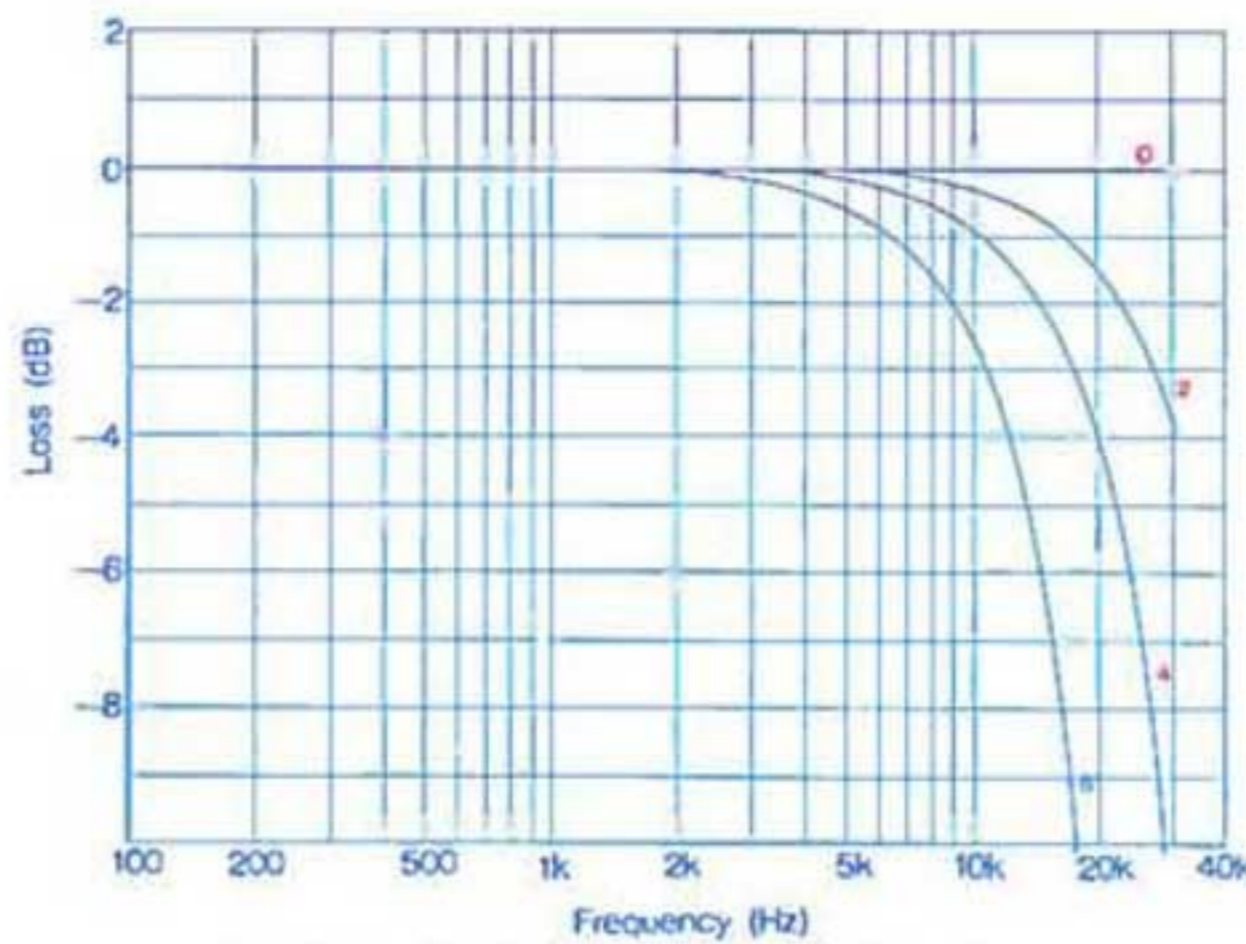

Figure 2 Frequency Response Loss Due To Azimuth Misalignment

NAAC (Nakamichi Auto Azimuth Correction) is the first system capable of extracting every bit of information stored on cassette. Obviously, it cannot reproduce what had never been recorded, but, if there is treble energy on the tape, NAAC will bring it to you with full fidelity and clarity *even if the tape has been recorded with improper azimuth!* NAAC automatically determines the *actual* recorded azimuth on the tape, aligns the *playback* head to it, and continues to track it throughout the program. NAAC works on *tape* — commercially recorded tapes, tapes borrowed from a friend, or those you made yourself. It works in *both* directions, requires no test tones, no setup, no action on your part at all!

NAAC utilizes the "phase-comparison" method of azimuth alignment, but, unlike systems that record test tones and adjust the *recording* head for in-phase left and right signals, NAAC determines the actual azimuth of the *recording* and aligns the playback head to it! It does not compare the phase in the left and right channels for, in stereo, the two contain different information. It works *within the same channel* by utilizing a unique playback head that splits the track in half and derives *two* signals from it. (Figures 3 and 4) The signals — "a" and "b" — are processed to extract the phase difference. This "error" drives a servo motor that realigns the playback head to the track. (Figure 5) The improvement in sound quality is nothing less than amazing!

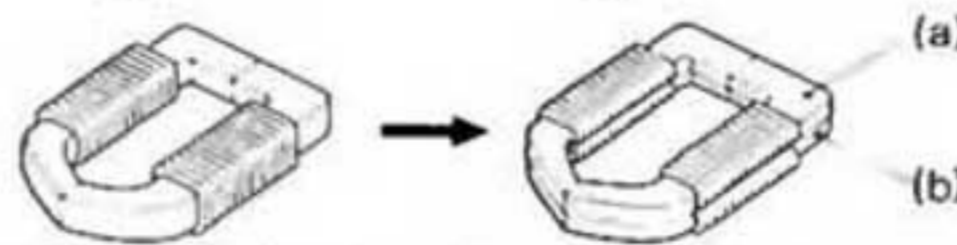

Figure 3 Standard core construction for one stereo channel.

Figure 4 Dual core construction for channel to be used for azimuth measurement.

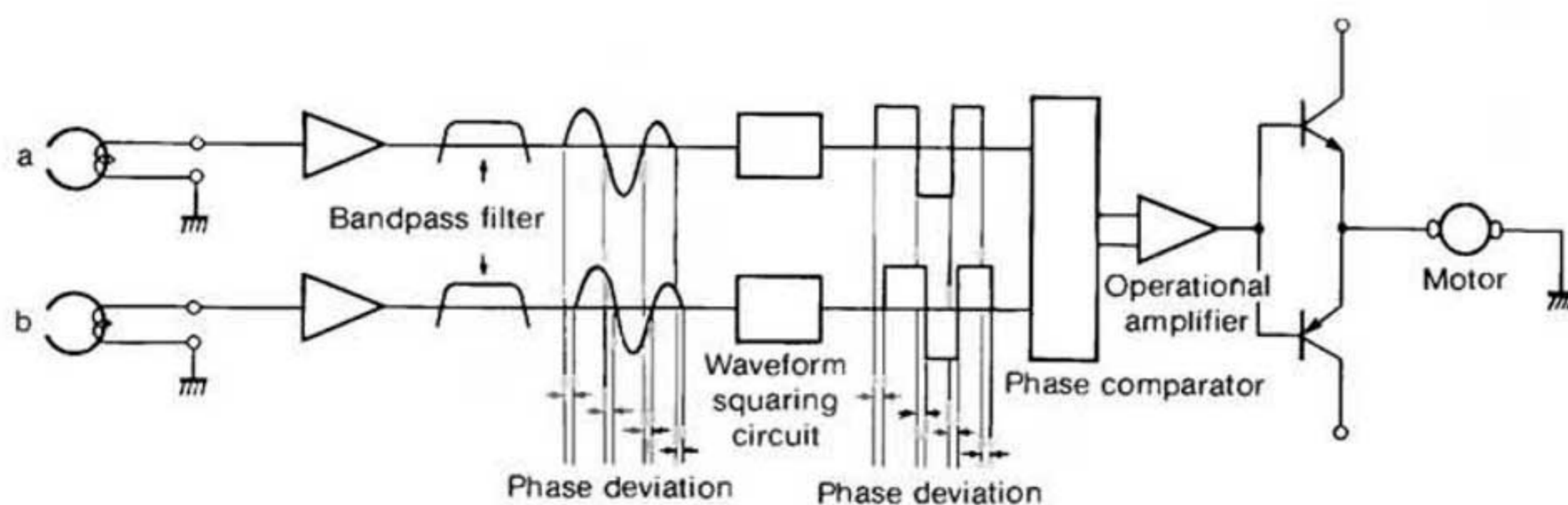

Figure 5 Automatic Playback Head Azimuth Correction System Block Diagram

Double-Direct-Drive Auto-Reverse Transport

DRAGON is the world's first Dual-Capstan, Double-Direct-Drive, Auto-Reverse cassette deck! Now you can have the convenience of auto-reverse playback *without* sacrificing treble response — thanks to NAAC — or speed stability — thanks to the Nakamichi Super-Linear-Torque motor. Actually, *two* SLT motors are used, one directly driving each capstan. Both are active in each direction so flutter and modulation noise are eliminated in *both* forward *and* reverse.

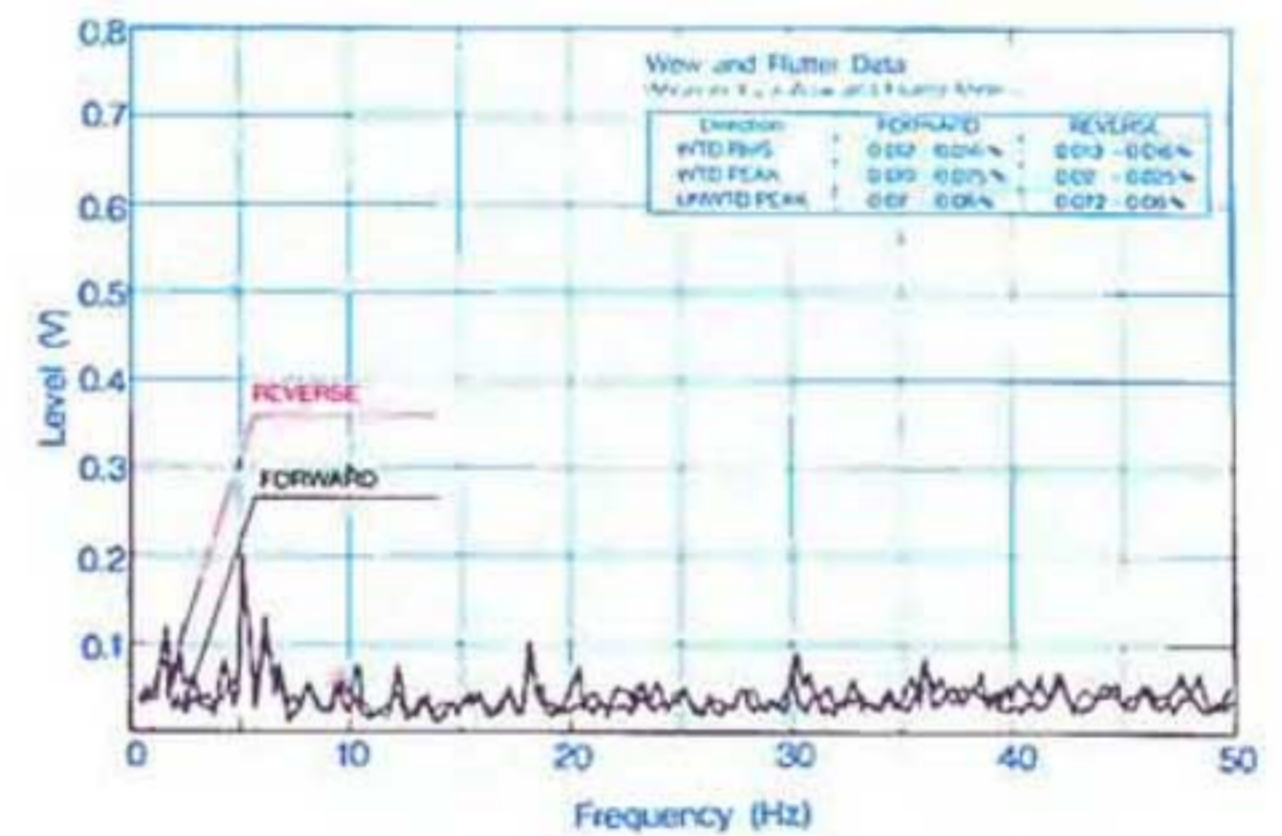

Figure 6 Flutter Spectral Analysis (UNWTD Peak)

Frequency : 3kHz Test Tape
Wow/Flutter Meter: Meguro MK-615
Spectrum Analyzer: HP-3582A



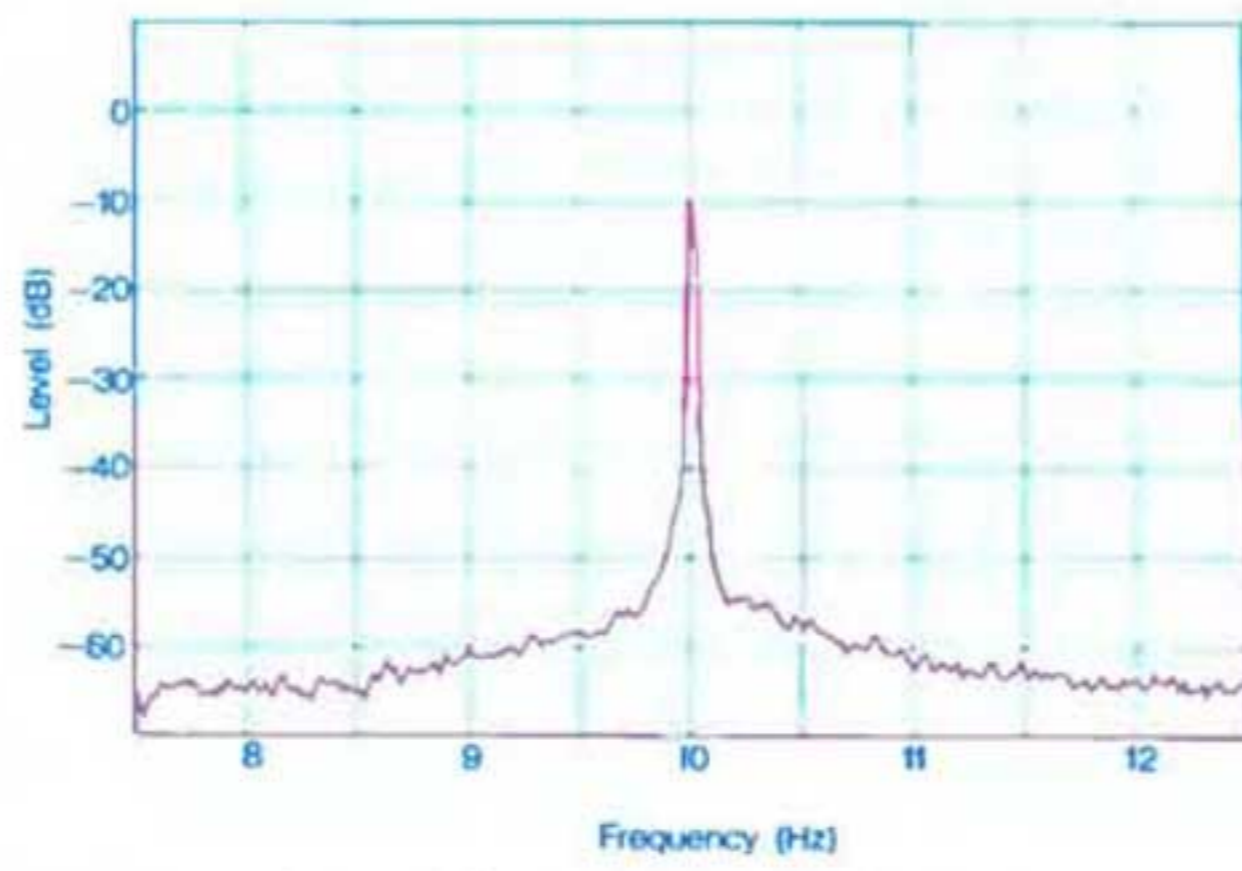

Figure 7 Modulation Noise Analysis
 Freq.:10kHz/ Tape:ZX (Metal)/ Eq:70µs

With its unusual star-shaped rotor magnetization, the SLT motor generates "cog-free" uniform torque. It eliminates "belt-drive wow" without introducing "direct-drive flutter." In a Double-Direct configuration like DRAGON, it produces less than 0.019% wow and flutter and virtual freedom from modulation noise! Figures 6 and 7 depict DRAGON's flutter spectrum and modulation noise. Note the peak-free flutter spectrum and the absence of side-bands about the 10-kHz tone. These characteristics, ignored by standard specifications, are responsible for DRAGON's remarkable tonal purity — the quality known as "Nakamichi Sound!"

DRAGON's SLT motors are locked to quartz reference in such a way that, in either direction, the supply capstan rotates 0.2% slower than the takeup capstan to provide precise control over tape tension and eliminate the need for a pressure pad. The capstans are "asymmetrical" to avoid resonance, and, since DRAGON is auto-reversing, an unusual mechanism ensures that the "supply" guide is automatically engaged and the "takeup" guide retracted.

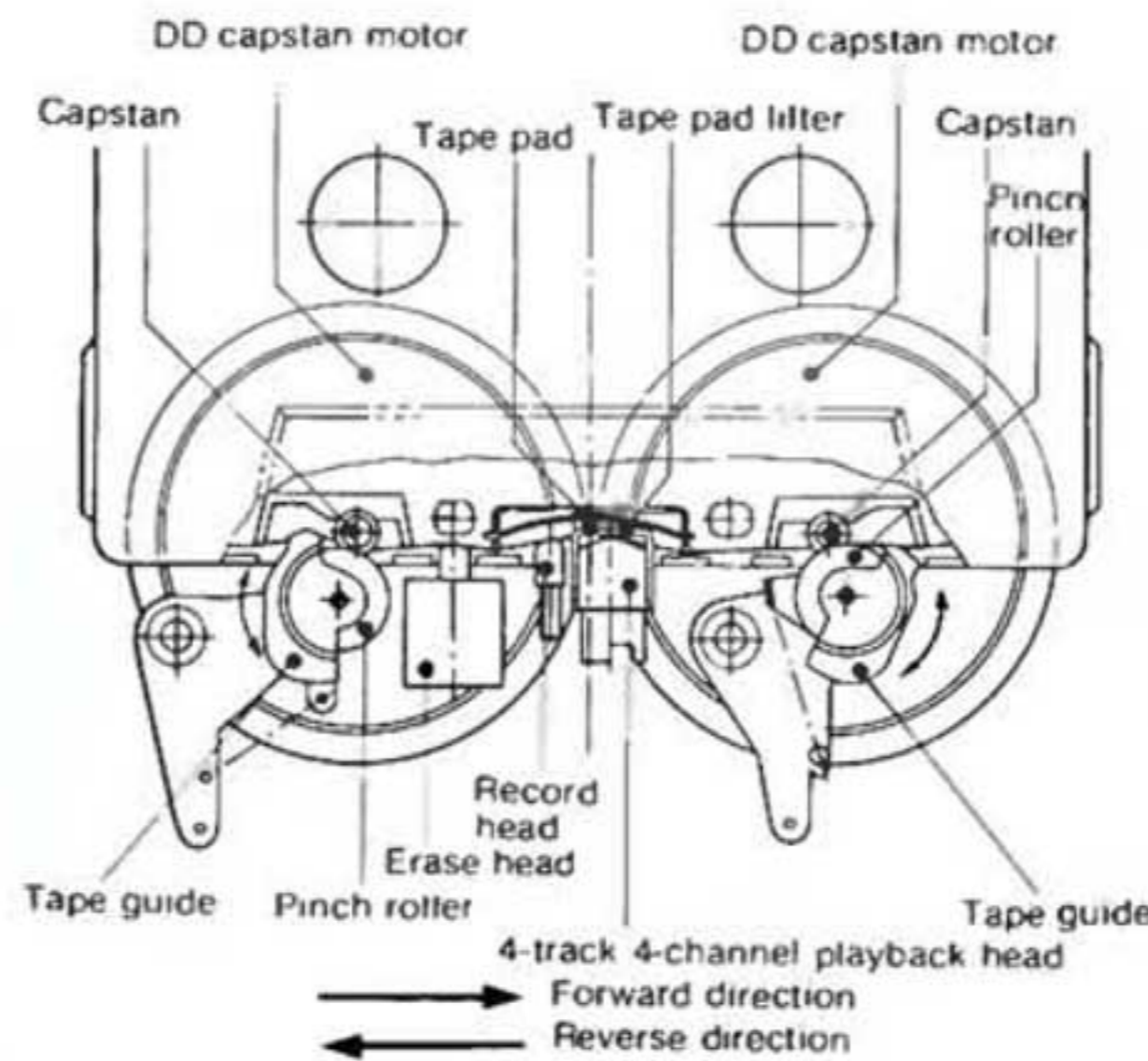

Figure 8 Auto-Reverse Dual-Capstan Double-Direct-Drive System Construction

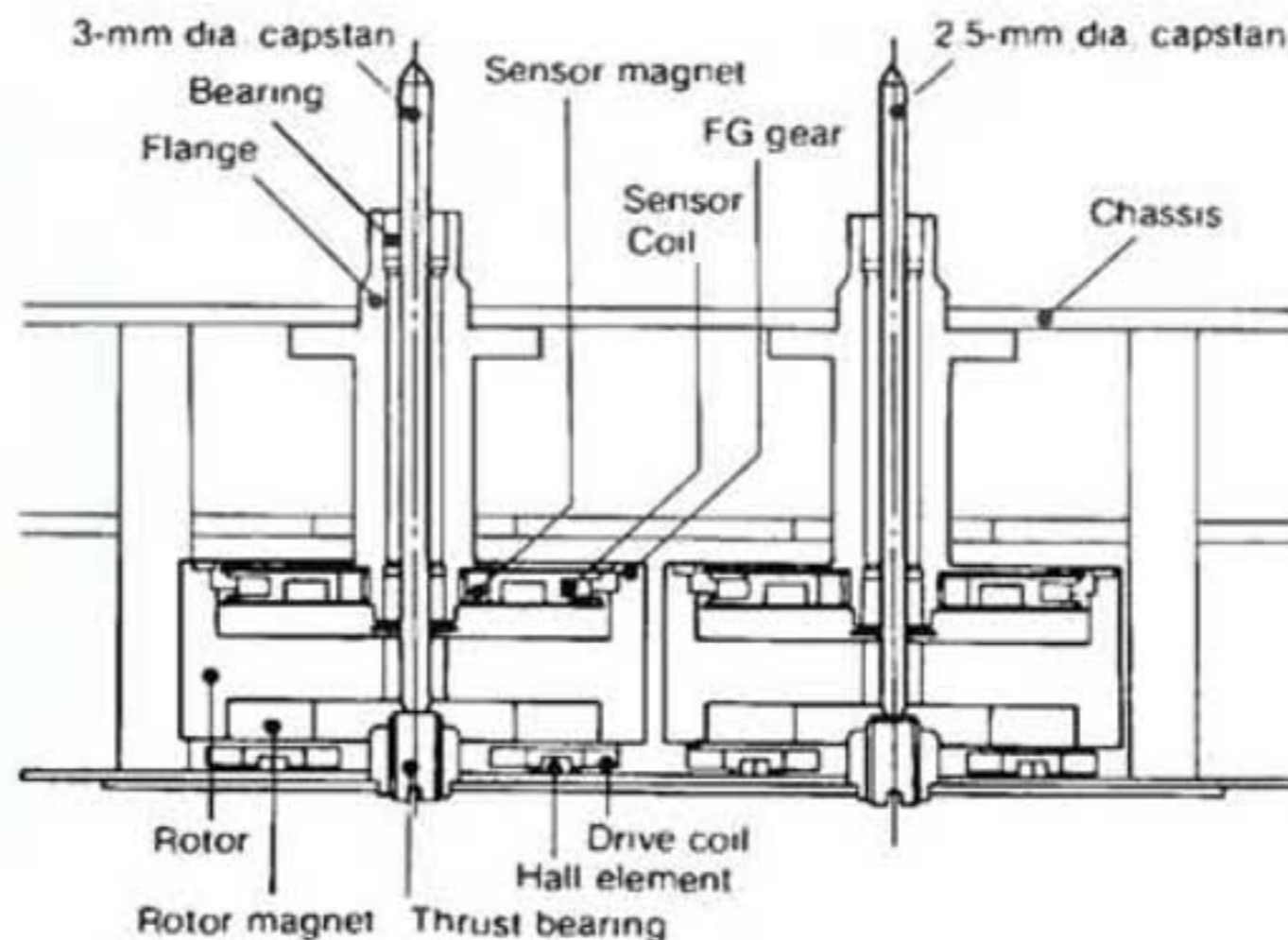

Figure 9 Auto-Reverse Dual-Capstan Double-Direct-Drive System Cross Section

Discrete 3-Head Technology In An Auto-Reverse Deck!

DRAGON also is the world's first Discrete 3-Head Auto-Reverse cassette deck! Now you can have the sound quality available *only* with this Nakamichi creation *and* the convenience of auto-reverse playback.



NAAC made high-fidelity reproduction possible in the auto-reverse format. But what made NAAC possible? The PA-1L 4-track/2-channel-stereo Crystalloy playback head — a unique creation of Nakamichi technology! Each stereo track is a mere 0.6 mm (24 *thousandths* of an inch) wide. Most engineers thought that it was impossible to divide the track into two parts and read separate signals from each, but this is exactly what Nakamichi creativity and expertise in magnetic technology has accomplished!

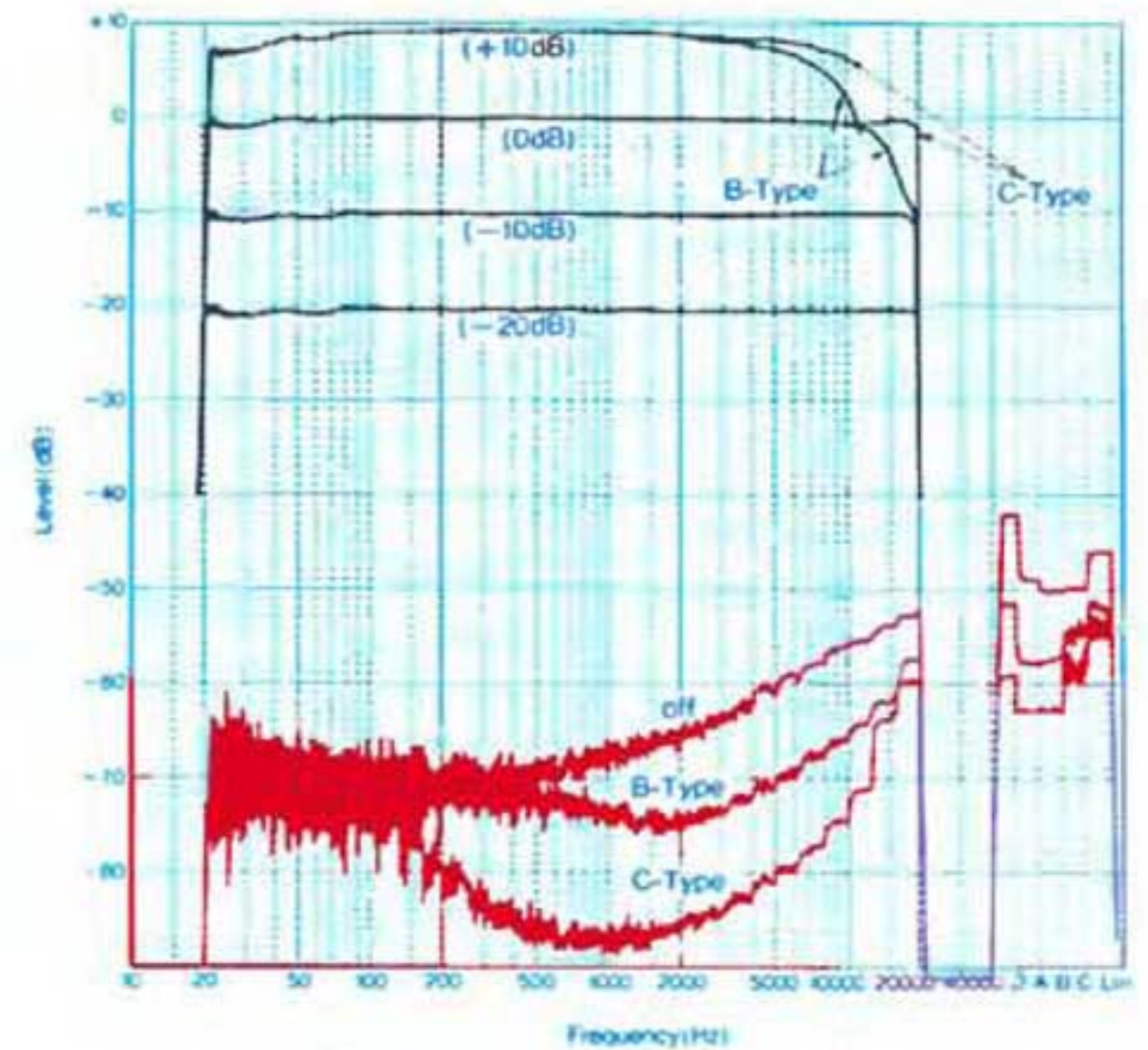

Figure 10 Frequency Response/Noise Analysis

Deck : Nakamichi DRAGON
 Tape : ZX (Metal)
 PB Eq : 70µs
 Dolby NR : Off

With its 2-track/2-channel Crystalloy recording head and dual-gap Ferrite/Sendust erase head, DRAGON records the *full* frequency spectrum — from 20 Hz to 22 kHz — in the forward direction and reproduces it in *either* direction with remarkable uniformity. Nakamichi's special poletip geometry suppresses low-frequency "head bumps" completely, and thanks to a special surface treatment, our heads have a useful life of more than 10,000 hours!

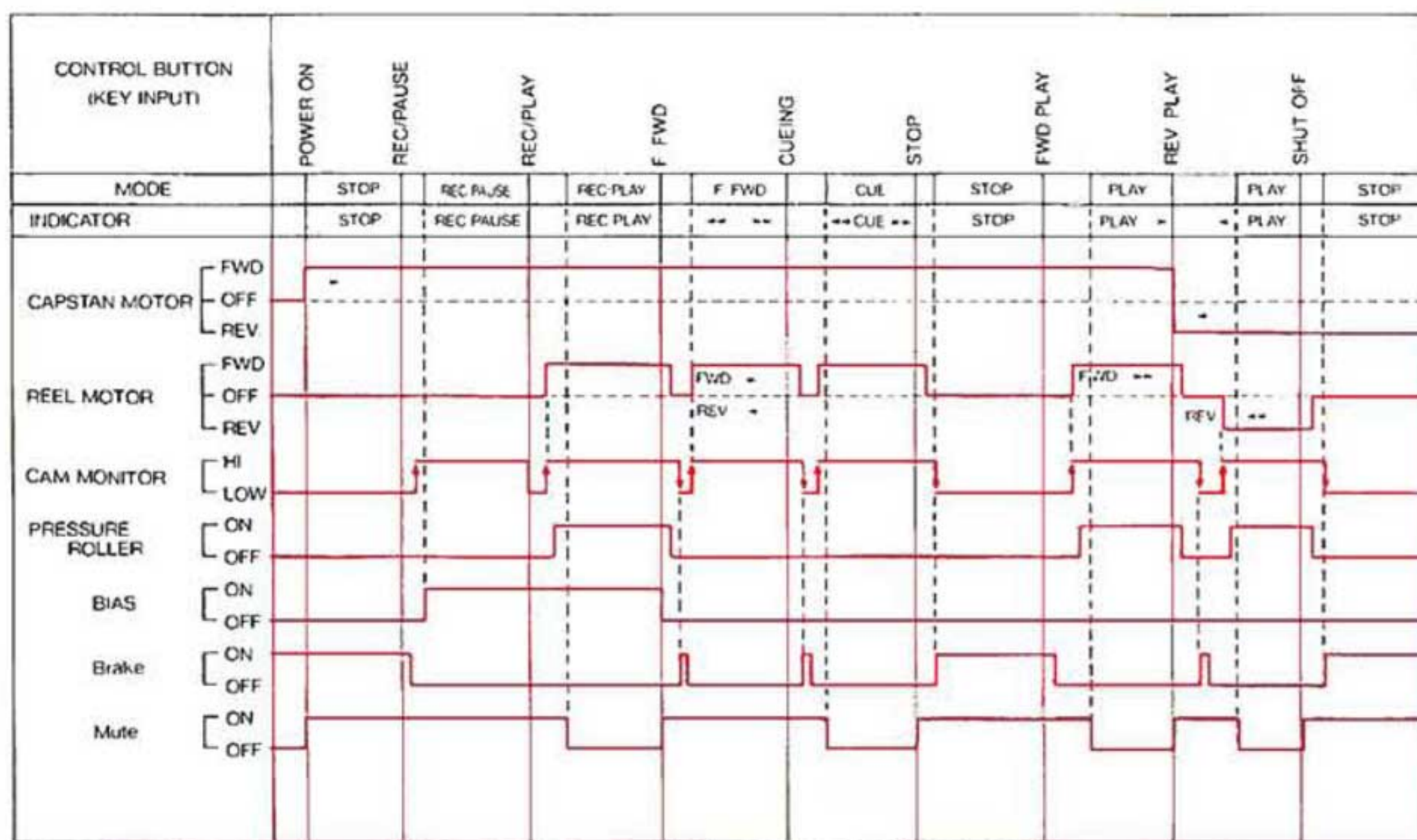

Figure 11 Transport Control Timing Chart

Precision And Convenience Through Microprocessor Control

DRAGON is intelligent! Three microprocessors monitor the control panel and key points in the operating system. The microprocessors instantly issue commands to a special motor-control mechanism that positions the heads, engages and disengages reel brakes and pinch rollers, and performs the mechanical functions normally assigned to solenoids. Figure 11 shows the system timing diagram and DRAGON's intricately interwoven operational modes.

The motor-control mechanism performs each change of function rapidly and much more precisely than is possible with solenoid actuation because the microprocessors monitor the control motor and thus place it inside a digital servo loop. Operation is remarkably smooth, quiet, and free of the jarring mechanical shock typical of solenoid operation.

Delicate mechanical adjustments are not disturbed and very little heat is generated. Thus mechanical and electrical reliability are greatly improved.

The chassis is fabricated from an aluminum alloy that is specially treated to absorb vibration before it can affect tape motion. This greatly improves speed stability, reduces flutter and modulation noise, and contributes to the unique purity of "Nakamichi Sound."



Mechanism-Control Microprocessors

The microprocessors determine drive motor speed and direction to provide flawless auto-reverse operation. With this "intelligence" in control of DRAGON's mechanism and circuitry, several unusual features are possible: Auto Record Pause, Easy Cueing, Punch-In Recording, and Memory Stop/Play.

Auto Record Pause

When you are dubbing a record onto tape, it is bothersome to constantly watch over the recording process in order to catch the end of the program. If your attention wanders or you're called away, it is easy to miss the end of the side; the tape continues to run, and you're left with a long length of blank tape. You must rewind to find the end of the last program and "splice" in the next.

Now, DRAGON's "intelligent" electronics can do the monitoring for you! Simply switch on Auto Rec Pause, and DRAGON checks the incoming program. If it finds a silence of more than 30 seconds, DRAGON automatically goes into Rec Pause. The tape stops, and you're ready to resume recording at the touch of a button!

Easy Cueing

Thanks to the "continuous" action of DRAGON's motor-driven control system and the "intelligence" of its microprocessors, cueing is exceptionally versatile. Pressing Cue during fast-forward or rewind reduces transport speed by one-third and brings the playback head close to the tape so you can hear the program. Pressing either fast-wind button again now drops tape speed to one-sixth normal for as long as the button is held. You can zero in on the start of a program very precisely!

Easy Cueing also is possible via the optional RM-20 Remote Control Unit. The RM-20's Pause button duplicates the action of the on-board Cue button whenever the deck is in either fast-wind mode.

Punch-In Recording

You can enter Record directly from Forward-Play by pressing Play and Record simultaneously so you can "splice" a new program into an old one very accurately. Punch-In Recording is possible either from the DRAGON control panel or via the RM-20 Remote Control Unit.

Memory Stop/Play

With Memory on, DRAGON automatically stops at a counter reading of "0000" in either fast mode. Depending upon whether "Stop" or "Play" had been selected, the tape either remains stationary or immediately begins playback.



Dual-Speed Auto Fader

DRAGON's dual-speed Auto Fader allows you to create professional-like level fades at the press of a button. Once you have adjusted recording balance and level with the independent left and right level controls, a quick tap on UP or DOWN produces a smooth 6-second fade up to or down from the preset level. If you hold either button down, the fade occurs just as smoothly but more rapidly — in 2 seconds.



Record Mute

You can prevent recording of the source signal entirely via the Rec Mute button. For as long as this button is pressed, the record amplifiers are muted, and a bland section of tape is recorded. This allows you to clearly delineate between recordings and to eliminate commercials.

The Record Mute function also is accessible by remote control. Once you are in the recording mode, pressing the RM-20's record button a second time activates the mute.

Calibration Controls For Optimum Recording

With NAAC's unique ability to reproduce every subtle nuance recorded on cassette, it is all the more important that each tape be created as perfectly as possible to take full advantage of this extraordinary system. DRAGON accommodates the three major tape types — "standard" ferric, chrome/ferricobalt, and metal. What's more, you can individually calibrate the system for best performance on the particular brand of tape you are using.

Separate sets of bias and record-level (sensitivity) controls are provided for each channel and tape type. Self-contained test oscillators generate a 400-Hz signal for setting record level and a 15-kHz tone for adjusting bias. In the calibration mode, DRAGON's recording indicators automatically become 20 dB more sensitive to improve the precision of adjustment.

It takes only a moment to calibrate DRAGON for peak performance, and it is a moment well spent! Tapes *do* differ in bias requirement and sensitivity. These differences are most apparent from brand to brand, but slight differences exist even between batches of the same brand! These can audibly affect high-frequency response and throw off Dolby tracking. Especially when using the more sophisticated Dolby-C system, perfect *basic* response is the key to total system fidelity.

Advanced Dolby Processing

DRAGON contains a highly sophisticated single-chip Dolby B-C processor. By employing this device rather than conventional cascaded Dolby-B chips, tolerances are eliminated, and a very wide dynamic range becomes possible.



High-Performance Electronics

DRAGON's electronic circuitry is of a quality rarely found in cassette decks. Distortion is kept under 0.005% — no small feat when you consider the complexity of tape-recording electronics! DRAGON actually has six separate preamp/equalizers in its playback chain to accommodate the NAAC system and provide for bi-directional playback.

Side-A/Side-B switching is entirely electronic — no clumsy unreliable head-rotation devices — and the switching is performed after preamplification to avoid noise. Each unit is hand calibrated at the factory to ensure perfect level matching and optimum performance.

MPX And Subsonic Filters

With DRAGON's broad frequency response — 20 Hz to 22,000 Hz — it may sometimes be desirable to eliminate unwanted signals in the recording amplifier. When taping an FM-stereo broadcast, for example, 19-kHz pilot from a misadjusted tuner could upset Dolby tracking. DRAGON's MPX filter prevents that from occurring!

At the other end of the spectrum, infrasonic signals generated when playing a warped record — especially with a tonearm/cartridge system whose resonance is poorly placed — can intermodulate with the music and produce an effect similar to wow. DRAGON's subsonic filter can then be called upon to eliminate the condition.

DRAGON's filters are independently switchable and so can be called into play only as needed.

Wide-Range Peak-Level Meters



DRAGON's peak-reading electronic meters span a full 50-dB range — from -40 dB to +10 dB — with 20 LED segments per channel. They are fast responding but hold the peak reading momentarily so they are easier to read. Being completely electronic, they are free of "pointer lag" and "overshoot." These precision instruments automatically increase sensitivity by 20 dB in the calibration mode to improve the precision of the adjustments.



DRAGON Features

- NAAC (Nakamichi Auto Azimuth Correction) System Automatically Adjusts Playback-Head Azimuth To Agree With Each Cassette
- Auto-Reverse, Asymmetrical, Dual-Capstan, Double-Direct-Drive Transport On Non-Resonant Chassis
- Dual Super-Liner-Torque DD Capstan Motors Phase Locked To Quartz Crystal
- Motor-Driven Control System Under Supervision Of Three Microprocessors
- Auto-Retracting Slot Guides And Tape-Pad Lifter
- Discrete Three-Head Technology Employing Unique Quadruple Split-Track Playback Head With 20—22,000 Hz ± 3 dB Response
- Laminated Crystalloy Record And Playback Heads For Reduced Distortion
- Dual-Gap Ferrite/Sendust Erase Head For Low-Noise Erasure Of Metal Tape
- Individual Bias And Record-Level Calibration Controls For Each Channel And Tape Type With Two-Tone Test Oscillator
- Auto Rewind After Calibration Via Calibration-Reset Button
- Separate Tape And Equalization Switches For ZX, SX, and EX Tapes
- Double Dolby-B And Dolby-C Noise Reduction Employing One-Chip Processors
- Defeatable MPX Filters For FM-Stereo Recording
- Defeatable Subsonic Filters For Phono-Disc Recording
- Master Input Level Control With Individual Left And Right Controls To Establish Balance
- Full Off-Tape Monitoring
- Two-Speed Auto-Fader For Professional Fades Plus Record Mute
- Auto Record Pause
- Punch-In Recording In Forward Direction
- 50-dB Peak-Responding Electronic LED Metering
- Six Discrete Equalizer/Amplifiers
- Direct-Coupled Record And Playback Amplifiers
- Two-Speed Easy Cue
- Output Level Control
- High-Output Headphone Jack Plus DC Power For BlackBox Series
- 4-Digit LED Electronic Counter (-999 to 9999) With Memory Stop And Memory Repeat
- Unattended Operation In Record Or Playback Via Accessory Timer
- Remote Control Capability Via RM-20 Option



RM-20 Remote Control

DRAGON Specifications

Track Configuration.....	4 tracks/2-channel stereo (Playback Auto Reverse)
Heads.....	3 (erase head \times 1, record head \times 1, 4-track, 4-channel playback head \times 1)
Motors	<ul style="list-style-type: none"> • TRANSPORT Quartz PLL DC, brushless, slotless, coreless Super Linear Torque D.D. Motor (capstan drive) \times 2, DC Motor (reel drive) \times 1 • AUTO AZIMUTH CORRECTION DC Motor \times 1 • MECHANISM DC Motor \times 1
Power Source	100, 120, 120/220-240, 220 or 240V AC; 50/60Hz (According to country of sale)
Power Consumption	45 W max.
Tape Speed.....	1-7/8 ips. (4.8 cm/sec.)
Wow-and-Flutter.....	Less than 0.019% WTD RMS Less than $\pm 0.04\%$ WTD Peak
Frequency Response	20 Hz—22,000 Hz ± 3 dB (recording level -20dB, ZX tape) 20 Hz—21,000 Hz ± 3 dB (recording level -20dB, SX, EX II tape)
Signal-to-Noise Ratio	Dolby C-Type NR on $<70 \mu\text{s}$, ZX tape Better than 72 dB (400 Hz, 3% THD, IHF A-WTD RMS) Dolby B-Type NR on $<70 \mu\text{s}$, ZX tape Better than 66 dB (400 Hz, 3% THD, IHF A-WTD RMS)
Total Harmonic Distortion	Less than 0.8% (400 Hz, 0 dB, ZX tape) Less than 1% (400 Hz, 0 dB, SX, EX II tape)
Erase	Better than 60 dB (100 Hz, 0 dB)
Separation.....	Better than 37 dB (1 kHz, 0 dB)
Crosstalk	Better than 60 dB (1 kHz, 0 dB)
Bias Frequency.....	105 kHz
Input (Line)	50 mV, 50 k Ω
Output (Line)	1 V (400 Hz, 0 dB, output level control at max.) 2.2k Ω
(Headphone).....	45 mW (400 Hz, 0 dB, output level control at max.) 8 Ω
BlackBox Series DC Output	± 10 V, 125mA max.
Dimensions	450(W) \times 135(H) \times 300(D) mm 17-3/4(W) \times 5-5/16(H) \times 11-13/16(D) inches
Weight	Appr. 9.5 kg 21 lb

- Specifications and appearance subject to change for further improvement without notice.
- Dolby NR under license from Dolby Laboratories Licensing Corporation.
- The word "DOLBY" and the Double-D symbol are trademarks of the Dolby Laboratories Licensing Corporation.



SP-7 Stereo Headphones



Tapes

ZX Metalloy Cassette Tape
(70 μs , metal bias)
ZX C-60 ZX C-90

SX Ferricobalt Cassette Tape
(70 μs , CrO₂ bias)
SX C-60 SX C-90

EX Ferrioxide Cassette Tape
(120 μs , normal bias)
EX C-60 EX C-90

SX II Super Ferricobalt Tape
(70 μs , CrO₂ bias)
SX II C-60 SX II C-90

EX II Ferricrystal Cassette Tape
(120 μs , normal bias)
EX II C-60 EX II C-90



DM-10 Head Demagnetizer

Nakamichi Corporation
Tokyo Office
Nakamichi U.S.A. Corporation
Nakamichi GmbH

Shinjuku Daiichi Seimei Bldg., 2-7-1 Nishishinjuku, Shinjuku-ku, Tokyo
Phone: (03) 342-4461 Telex: 2324721 (NAKAMJ)
19701 South Vermont Avenue, Torrance, California 90502 Phone: (213) 538-8150
Stephanienstrasse 6, 4000 Düsseldorf 1 Phone: (0211) 359036