



XRT29
Loudspeaker
System



XRT29

WARNING - TO REDUCE RISK OF FIRE OR ELECTRICAL SHOCK, DO NOT EXPOSE THIS EQUIPMENT TO RAIN OR MOISTURE.

NO USER-SERVICEABLE PARTS INSIDE. REFER SERVICING TO QUALIFIED PERSONNEL.

IMPORTANT SAFETY INSTRUCTIONS!

PLEASE READ THEM BEFORE OPERATING THIS EQUIPMENT.

General:

1. Read these instructions.
2. Keep these instructions.
3. Heed all warnings.
4. Follow all instructions.
5. **Warning: To reduce risk of fire or electrical shock, do not expose this equipment to rain or moisture. This unit is capable of producing high sound pressure levels. Continued exposure to high sound pressure levels can cause permanent hearing impairment or loss. User caution is advised and ear protection is recommended when playing at high volumes.**
6. Only use attachments/accessories specified by the manufacturer.

Installation:

7. Install in accordance with the manufacturer's instructions.
8. Do not install near any heat sources such as radiators, heat registers, stoves, or other equipment (including amplifiers) that produce heat.
9. Do not use this equipment near water.
10. Do not expose this equipment to dripping or splashing and ensure that no objects filled with liquids, such as vases, are placed on the equipment.
11. Use only with the cart, stand, tripod, bracket, or table specified by the manufacturer, or sold with the equipment. When a cart is used, use caution when moving the cart/equipment combination to avoid injury from tip-over.



Care of Equipment:

12. Clean only with a dry cloth.
13. Do not permit objects or liquids of any kind to be pushed, spilled and/or fall into the equipment through enclosure openings.

Repair of Equipment:

14. Refer all servicing to qualified service personnel. Servicing is required when the equipment has been damaged in any way, liquid has been spilled or objects have fallen into the equipment, the equipment has been exposed to rain or moisture, does not operate normally, or has been dropped.
15. Do not attempt to service beyond that described in the operating instructions. All other service should be referred to qualified service personnel.
16. When replacement parts are required, be sure the service technician has used replacement parts specified by McIntosh or have the same characteristics as the original part. Unauthorized substitutions may result in fire, electric shock, or other hazards.
17. Upon completion of any service or repairs to this product, ask the service technician to perform safety checks to determine that the product is in proper operating condition.

Thank You

Your decision to own this McIntosh XRT29 Loudspeaker System ranks you at the very top among discriminating music listeners. You now have “The Best.” The McIntosh dedication to “Quality,” is assurance that you will receive many years of musical enjoyment from this unit.

Please take a short time to read the information in this manual. We want you to be as familiar as possible with all the features and functions of your new McIntosh.

Please Take A Moment

The serial number, purchase date and McIntosh Dealer name are important to you for possible insurance claim or future service. The spaces below have been provided for you to record that information:

Serial Number: _____

Purchase Date: _____

Dealer Name: _____

Technical Assistance

If at any time you have questions about your McIntosh product, contact your McIntosh Dealer who is familiar with your McIntosh equipment and any other brands that may be part of your system. If you or your Dealer wish additional help concerning a suspected problem, you can receive technical assistance for all McIntosh products at:

McIntosh Laboratory, Inc.
2 Chambers Street
Binghamton, New York 13903
Phone: 607-723-1545
Fax: 607-723-3636

Customer Service

If it is determined that your McIntosh product is in need of repair, you can return it to your Dealer. You can also return it to the McIntosh Laboratory Service Department. For assistance on factory repair return procedure, contact the McIntosh Service Department at:

McIntosh Laboratory, Inc.
2 Chambers Street
Binghamton, New York 13903
Phone: 607-723-3515
Fax: 607-723-1917

Table of Contents

Safety Instructions	2
Thank You and Please Take a Moment	3
Technical Assistance and Customer Service	3
Table of Contents and Important Information	3
Introduction	4
Performance Features	5
Dimensions	6
Installation	8
How to Connect using a single amplifier	10
How to Connect using two amplifiers	12
Specifications	14
Packing Instruction	15

Important Information

Caution: The XRT29 High Frequency Column weight is 82 pounds (37.20kg) net. It requires two or more persons to safely handle the column.

- 1. Loudspeaker Cables of adequate size are important to ensure that there will be no significant power loss or heating. Cable size is specified in Gauge numbers or AWG (American Wire Gauge). The smaller the Gauge number, the larger the wire size:
If the Loudspeaker Cables are 25 feet (7.62m) or less, use at least 18 Gauge (AWG) wire size or larger.
If the Loudspeaker Cables are 50 feet (38.1m) or less, use at least 14 Gauge (AWG) wire size or larger.
If the Loudspeaker Cables are 100 feet (76.2m) or less, use at least 12 Gauge (AWG) wire size or larger.
The Loudspeaker Connection Terminals can accept up to 12 Gauge (AWG) wire.*
- 2. For additional connection information, refer to the owner's manual(s) for any component(s) connected to the XRT29 Loudspeaker.*
- 3. The XRT29 has built-in speaker protection in the form of three automatic resetting solid-state devices as part of the crossover networks. Two protect the tweeters and one for the midranges drivers. The characteristics of this protection are that a certain amount of overdrive is allowed but extended periods of overdrive will trigger protection. If an obvious lack of high or mid frequencies is noticed, the Loudspeaker Protection Device may have activated. The protection devices will automatically reset when the volume control is reduced significantly and kept low until the output of the affected Loudspeaker Element returns to normal.*
- 4. When the XRT29 Loudspeaker System is driven by more than one amplifier, the output levels of the different amplifiers connected to the Loudspeaker System must be adjusted to achieve a proper balance between the midrange and high frequencies reproduced. This adjustment is best achieved through the use of audio test equipment operated by a qualified installer.*
- 5. The XRT29 is designed to be used with a Subwoofer, like a McIntosh PS112, in order to hear the entire audible range of sound.*

Introduction

McIntosh Acoustic Engineers have refined the line source Column Loudspeaker concept to provide superior quality midrange and high frequency sound reproduction.

The High Frequency Section utilizes a patented Column Design¹ with multiple four inch Midrange LD/HP² Magnetic Circuit Design Drivers and one inch soft dome



Figure 1

Tweeters. Refer to figure 1. Since the audio power fed to a column is distributed among all the drivers, each driver does not have to work as hard, resulting in greater power handling capability and a dramatic reduction in distortion. The Sound Waves from the Column produce a Cylindrical Wave Front with a stable symmetrical horizontal sound dispersion to minimize undesirable floor and ceiling reflections

that could detract from a stable sound image. Refer to figure 2. In the illustration the Loud-

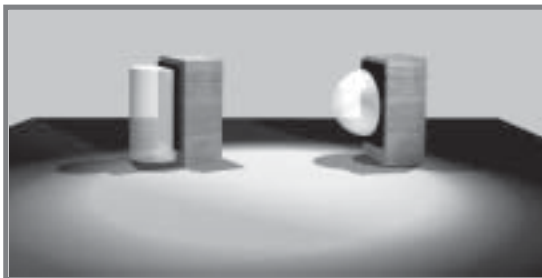

Figure 2

speaker on the left side produces a Cylindrical Wave Front and the Loudspeaker on the right side produces a conventional Spherical Wave Front.

The Midrange Drivers incorporate McIntosh's Patented LD/HP² Magnetic Circuit Design with shielding to greatly reduce any external magnetic field. Extensive investigating and testing resulted in a new design concept which utilizes a pair of aluminum shorting sleeves in the magnetic circuit. Refer to figure 3. The sleeves virtually eliminate the negative influence of the fluctuating voice coil field on the permanent magnet field.



Figure 3

This results in lower distortion due to more linear mag-

netic flux in the voice coil gap. Refer to figure 4. Additional benefits are less volume compression due to improved heat transfer through the sleeves and a cooler operating voice coil. Both measurements, as well as critical listening, reveal ten times less distortion than previous designs. A good example of this low distortion is incredible smoothness and clarity in the reproduction of the human voice.

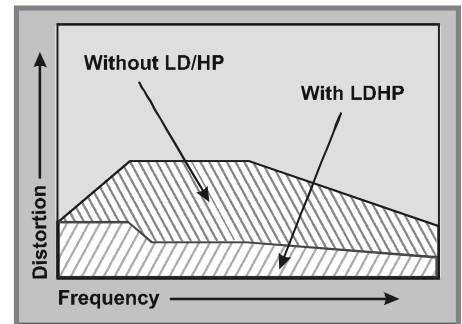

Figure 4

The Crossover Network used in the XRT29 Loudspeaker System is designed to ensure an even frequency response over its audible range. The Crossover Network utilizes both Second and Third Order Crossover Designs. Refer to figure 5. It also uses Capacitors and Inductors with high current capacity. The Capacitors used include low loss (ESR) Polypropylene and Mylar types. The Crossover Network utilize self resetting high current Poly-Switches to provide an extra measure of protection.

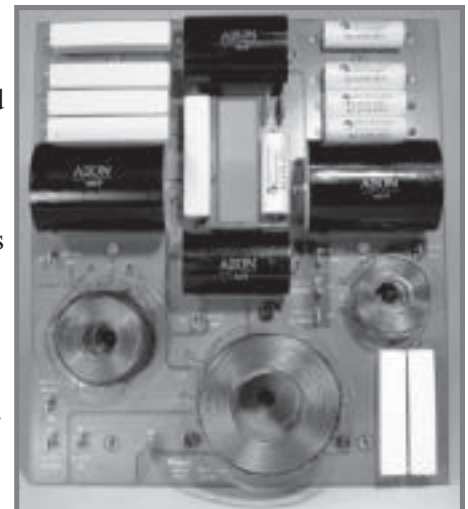

Figure 5

The enclosure is an important part of the XRT29 Loudspeaker System. The High Frequency Column utilizes a massive extruded aluminum enclosure that houses the 30 four inch Midrange and 25 one inch Tweeter Drivers. Refer to figure 6. It also has multiple front to back internal braces to form a dampened rigid Column Structure. The Column's small footprint allows for a variety of different placements in a room.

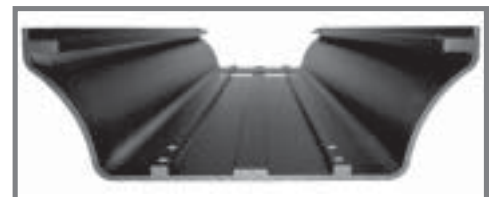

Figure 6

¹COLUMN Pat. No. 4,267,405

²LD/HP Pat. No. 5,151,943

Performance Features

- **Patented LD/HP Technology**

The McIntosh Midrange Loudspeaker Elements feature the patented LD/HP Magnetic Circuit Design. This design, when compared to conventional Loudspeaker Elements, reduces distortion significantly. It also increases power handling and efficiency.

- **Neodymium-Iron-Boron Alloy Magnets**

The 30 four inch Midranges and 25 one inch Dome Tweeters all use this Alloy. The Neodymium-Iron-Boron Alloy has a high flux density per unit of volume and helps to keep the Column weight to a minimum.

- **Controlled Magnetic Field**

The XRT29 may be used in Home Theater Installations near a television receiver or monitor without causing the television image to degrade. McIntosh has designed a controlled magnetic structure of the XRT29 Loudspeaker Elements to prevent interference.

- **High Power Handling**

The Loudspeaker Elements and Crossover Components of the XRT29 are all chosen for use with powerful amplifiers up to 1,200 watts.

- **Superior Imaging**

Locating the Column of Tweeters between the two Columns of Midranges helps to generate a symmetrical horizontal polar response for superior imaging.

- **Versatile Operation and Placement**

In addition to the regular connections, the XRT29 Loudspeaker System provides separate connections for Bi-Amplification hookups. The Crossover Network has an input provision to ensure the best performance when the High Frequency Column is mounted in-wall.

- **Gold Plated Input Connectors**

The XRT29 input connectors are gold plated for superior corrosion resistance and high electrical conductivity.



XRT29 Column Section Dimensions

The following dimensions can assist in determining the best location for your XRT29 Loudspeaker System.

**Front View of the
XRT29
High Frequency Column**

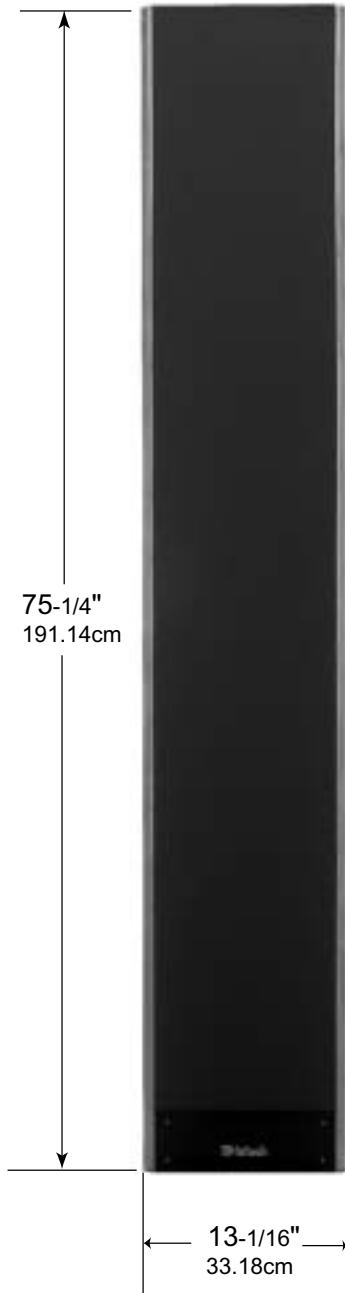

**Side View of the
XRT29
High Frequency Column
(without grille)**



**Rear View of the
XRT29
High Frequency Column**



**Front View of the
XRT29
High Frequency Column**



**End View and Base of the
XRT29
High Frequency Column**

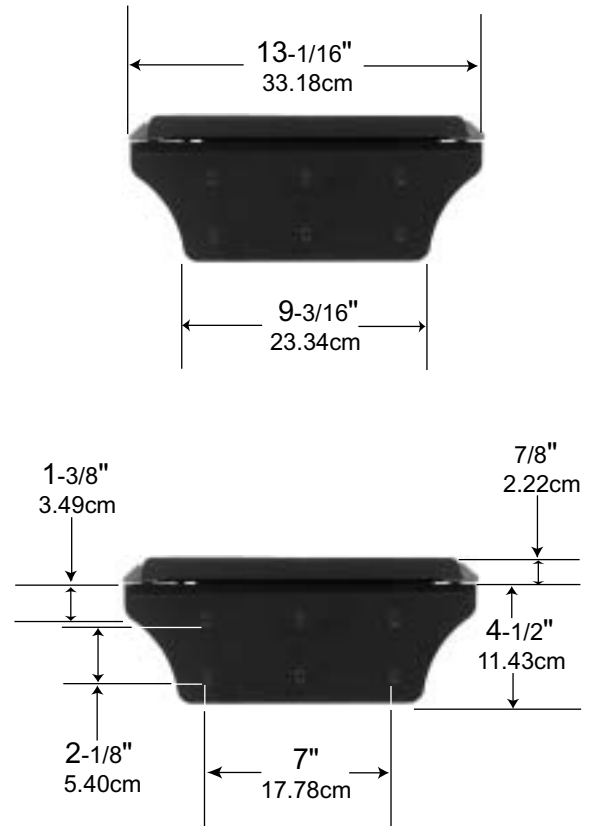

Installation

The XRT29 High Frequency Column requires two or more persons to safely handle the Column during assembly and placement. Follow the instructions below for unpacking and assembly. It is recommended that the Professionals at your McIntosh Dealer, who are skilled in all aspects of installation and operation, install the XRT29 Loudspeaker System and any associated audio equipment.

Unpacking the High Frequency Column

1. Remove the banding material from the shipping carton. Refer to figure 7.
2. Lift off the top of the shipping carton and set it aside.
3. Lift up on the rear of the Column Loudspeaker, near the foam packing material at both ends. Place the entire assembly (Column, Loudspeaker Grille and foam packing material) next to the bottom shipping carton on a flat surface. Refer to figure 8.
4. Release the Loudspeaker Grille from the packing material by opening the slit in the packing material located on the top center. Remove the Loudspeaker Grille from the protective shipping wrap and set it aside.
5. In a similar manner, lift out the Loudspeaker Column and set it aside.
6. Replace the shipping carton top onto the shipping carton bottom. Take the two center pieces of the just removed packing material and lay it down flat onto the top of the shipping carton.
7. Carefully remove the protective shipping bag(s) from the Loudspeaker Column so as not to mar the Column Finish or damage the Loudspeaker Drivers.
8. Place the Loudspeaker Column on top of the packing material located on top of the shipping carton making sure to align the Column Bottom End (the Glass Name

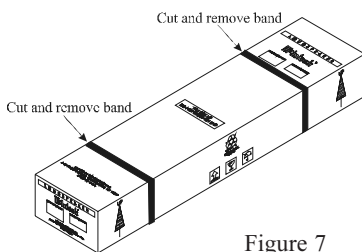

Figure 7

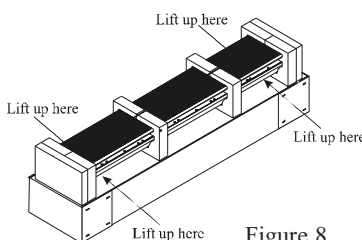

Figure 8

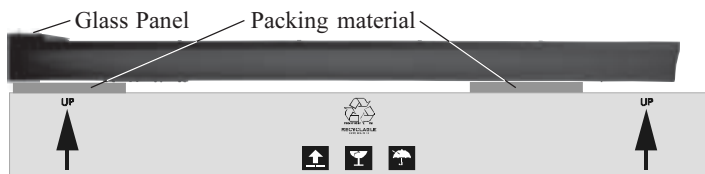

Figure 9

Plate end) to the end of the shipping carton. Refer to figure 9.

Assembling the High Frequency Column

The XRT29 may be installed using one of three installation methods. The first method is using the On-Wall Mounting Brackets supplied with the XRT29, allowing for surface mounting on a flat surface such as a wall. The second method is using the optional McIntosh CK29, In-Wall Mounting Brackets. The third method is using the optional McIntosh ST29 Column Base. If the CK29 In-Wall Mounting Brackets or ST29 Column Base installation method is chosen, then follow the instructions in the Installation Guide supplied with them at this time instead of the steps below.

The supplied On-Wall Mounting Brackets allow for two different mounting positions of the XRT29 Column relative to the wall. The first position is with the Column close to and parallel with the wall. The second position places the Column further away from the wall and allows for horizontal rotation of ± 30 Degrees.

Note: The supplied On-Wall Brackets and hardware are intended for vertical mounting of the Column, on a wood studded wall with up to 1 inch (2.54cm) thick wall covering surface (drywall). If the column is to be mounted onto other wall construction materials or positions contact your McIntosh Dealer for additional information.

9. Decide on which mounting position will be used for the column, refer to figure 10 and using the supplied Allen Wrench, remove one of the center screws from both ends of the Column.

Note: Save the just removed screws for possible later use.



Figure 10

10. Attach the Nylon Pivot Pin to one of the L Mounting Brackets using the short Pivot Pin Screw and Lock Washer. Refer to figures 11 and 12 for the correct opening location.
11. Attach the other L Mounting Bracket to the Top of the Column using the long Pivot Screw and Steel Bushing into the correct opening, based on the desired mounting position.
12. Determine the Column Mounting Location on the wall making sure that the Mounting Brackets will be anchored to the studs located inside the wall.
13. Referring to figures 11 and 12 install the Mounting Sleeve on the wall (orient with opening at the top) us-

ing the supplied Mounting Screws.

- Referring to figure 12, measure down from the just mounted L Bracket and install the Bottom L Bracket together with the Shim Plate, using the supplied Mounting Screws.

Top and Bottom L Mounting Bracket

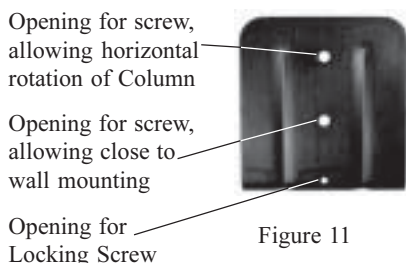

Figure 11

- With two persons, orient the Column End with the Top L Bracket above the Mounting Sleeve and carefully line up the bracket with the sleeve. Lower the Column onto the Nylon Pivot Point on the Bottom L Bracket while at the same time the Top L Bracket is inserted into the Mounting Sleeve.

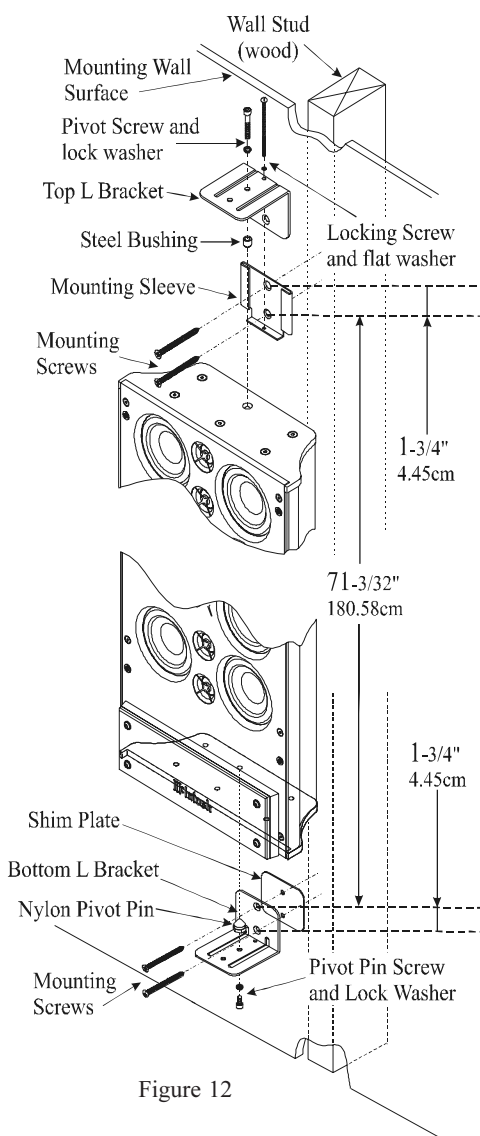

Figure 12

- Install the Locking Screw together with the Flat Washer into the opening on the Top L Bracket to secure the Column.
- Orient the Loudspeaker Grille with the extended wood trim pointed towards the Column Base and line it up even with top/sides of the Column. Align the Grille fastening pins to the Column Grommets (there are six pins on each side). Carefully push down to secure the Grille to the Column.

Room Placement

Loudspeaker placement in a room can greatly affect performance. The XRT29 Loudspeaker is designed for both Music and Home Theater Systems. The optimal method for selecting speaker locations includes the use of a real time spectrum analyzer operated by an experienced system installer. An uncompromising installation would take into consideration the floor, wall and ceiling coverings, the type and placement of furniture and can even include the architectural design of the room and its construction materials. In those instances where placement in the room is fixed, an environmental equalizer may be needed to restore proper musical balance. Experiment with various Loudspeaker positions to determine the best sounding location.

Locating Loudspeakers for use in Home Theater

In a Home Theater application, the placement of Left and Right Front Loudspeakers can be limited by such considerations as the size and location of the video monitor. The locating suggestions in the “for use in a Music System” section below can still be helpful as a starting place. Refer to figure 13.

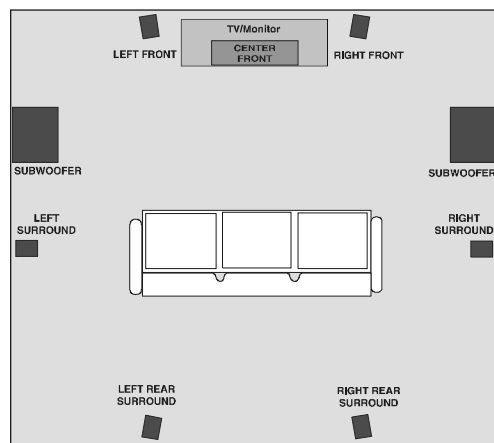

Figure 13

Locating Loudspeakers for use in a Music System

When used in a Music System the distance between the Loudspeakers and the listener to the Loudspeakers should form an isosceles triangle. If the speakers are too far apart relative to the listener, some imaging can be lost. Refer to figure 14.

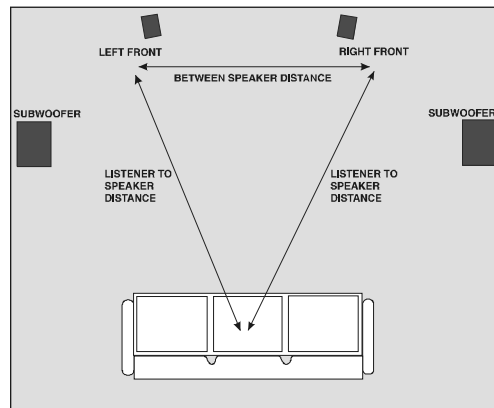

Figure 14

How to Prepare Hookup Cables

The McIntosh XRT29 Loudspeaker System utilizes binding posts for speaker wire connections. Prepare the Loudspeaker Hookup Cables that attach to the Power Amplifier Output Terminals:

Bare wire cable ends:

Carefully remove sufficient insulation from the cable ends, refer to figures 20, 21 & 22. If the cable is stranded, carefully twist the strands together as tightly as possible.

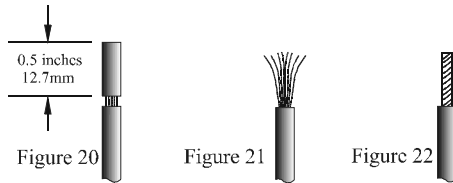

Note: If desired, the twisted ends can be tinned with solder to keep the strands together and/or attach a spade lug.

Spade lug or prepared wire connection:

Insert the spade lug connector or prepared section of the cable end into the terminal side access hole, and tighten the terminal cap until the cable is firmly clamped into the terminal so the wires cannot slip out. Refer to figures 23, 24 & 25.

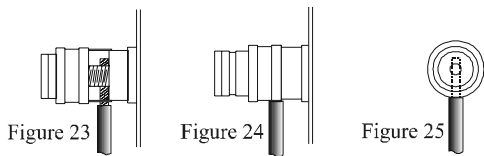

How to Connect using a single Amplifier

1. Connect a Loudspeaker Cable from the Negative (-) Binding Post of the Amplifier to the COLUMN MID COMMON (-) Binding Post of the Column Loudspeaker.
2. Connect a Loudspeaker Cable from the Positive (+) Binding Post of the Amplifier to the COLUMN MID 4Ω (+) Binding Post of the Column Loudspeaker.

Note: The MID and HIGH COMMON (-) Binding Posts must have a jumper installed between them. Likewise the MID and HIGH 4Ω (+) Binding Posts must also have a jumper installed between them. If the XRT29 Column is install into a wall, use the MID IN-WALL Binding Posts instead of the Column MID Binding Posts.

3. Tighten all of the Loudspeaker and Amplifier Binding Posts.



XRT29 Column Loudspeaker

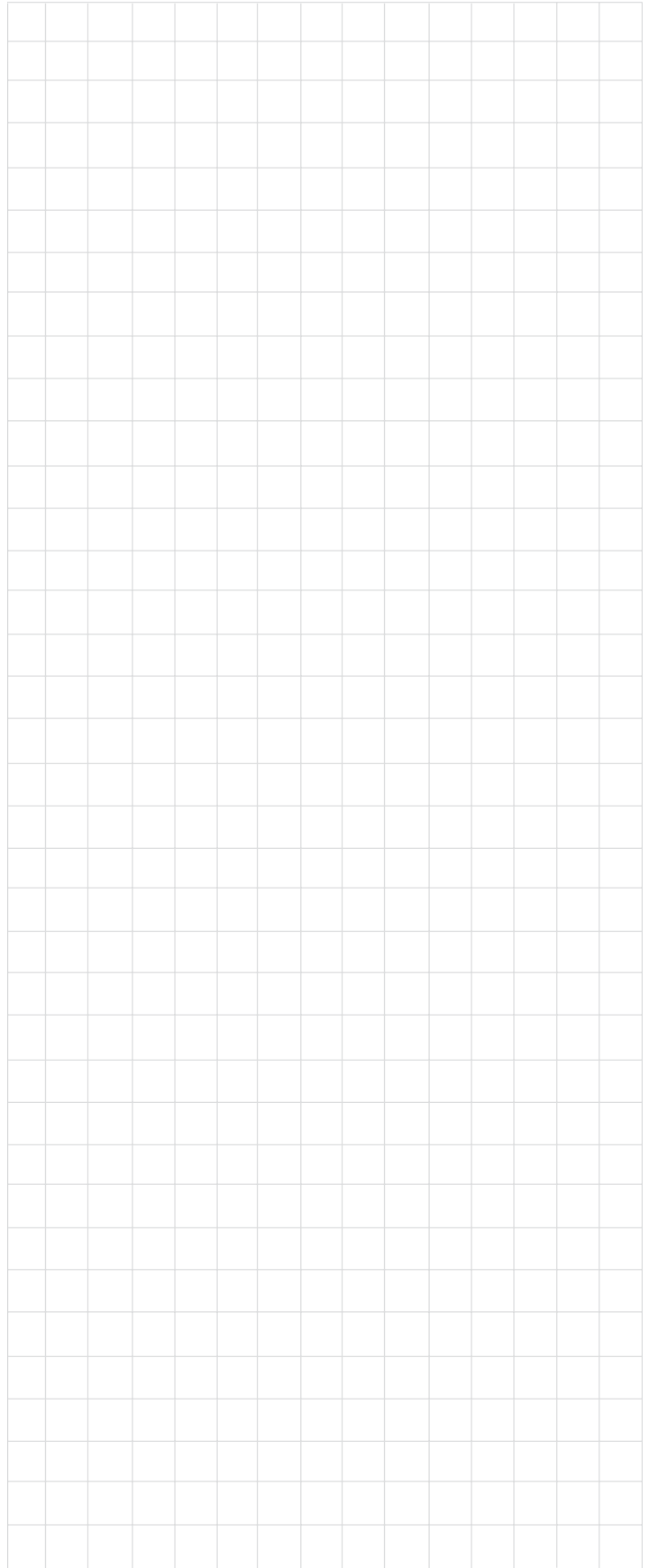

How to Prepare Hookup Cables

The McIntosh XRT29 Loudspeaker System utilizes binding posts for speaker wire connections. Prepare the Loudspeaker Hookup Cables that attach to the Power Amplifier Output Terminals:

Bare wire cable ends:

Carefully remove sufficient insulation from the cable ends, refer to figures 20, 21 & 22. If the cable is stranded, carefully twist the strands together as tightly as possible.

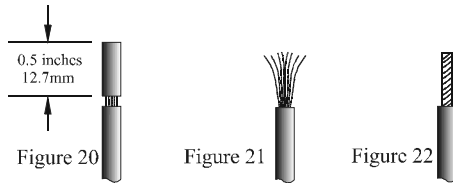

Note: If desired, the twisted ends can be tinned with solder to keep the strands together and/or attach a spade lug.

Spade lug or prepared wire connection:

Insert the spade lug connector or prepared section of the cable end into the terminal side access hole, and tighten the terminal cap until the cable is firmly clamped into the terminal so the wires cannot slip out. Refer to figures 23, 24 & 25.

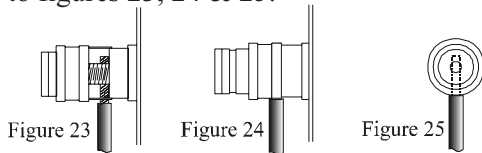

XRT29 Column Loudspeaker HIGH 4Ω (+) Binding Post.

6. Tighten all of the Loudspeaker and Amplifier Binding Posts.

McIntosh Single Channel Amplifier Number Two



How to Connect using two Amplifiers

1. Remove the jumpers from between the MID and HIGH Binding Posts on the XRT29 Column Loudspeaker and save them for possible future use.
2. Connect a Loudspeaker Cable from the Negative (-) Binding Post of the Amplifier Number One to the XRT29 Column Loudspeaker MID COMMon (-) Binding Post.

Note: If the XRT29 Column is installed into a wall, use the MID IN-WALL Binding Posts instead of the Column MID Binding Posts.

3. Connect a Loudspeaker Cable from the Positive (+) Binding Post of the Amplifier Number One to the XRT29 Column Loudspeaker MID 4Ω (+) Binding Post.
4. Connect a Loudspeaker Cable from the Negative (-) Binding Post of the Amplifier Number Two to the XRT29 Column Loudspeaker HIGH COMMon (-) Binding Post.
5. Connect a Loudspeaker Cable from the Positive (+) Binding Post of the Amplifier Number Two to the

McIntosh Single Channel Amplifier Number One

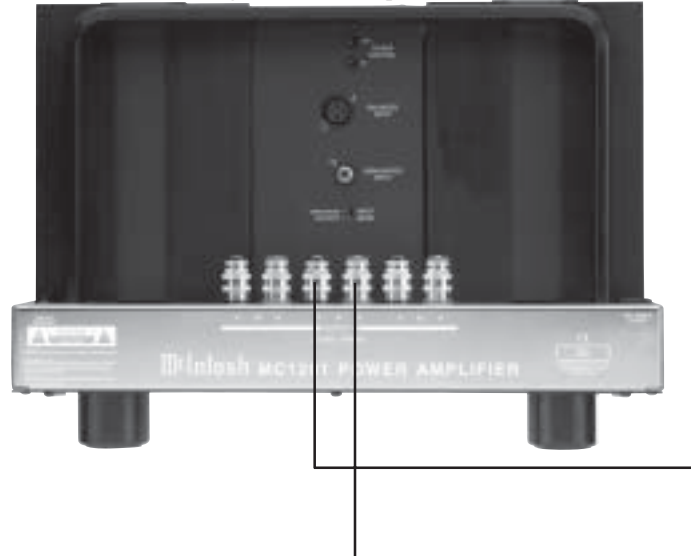

XRT29 Column Loudspeaker

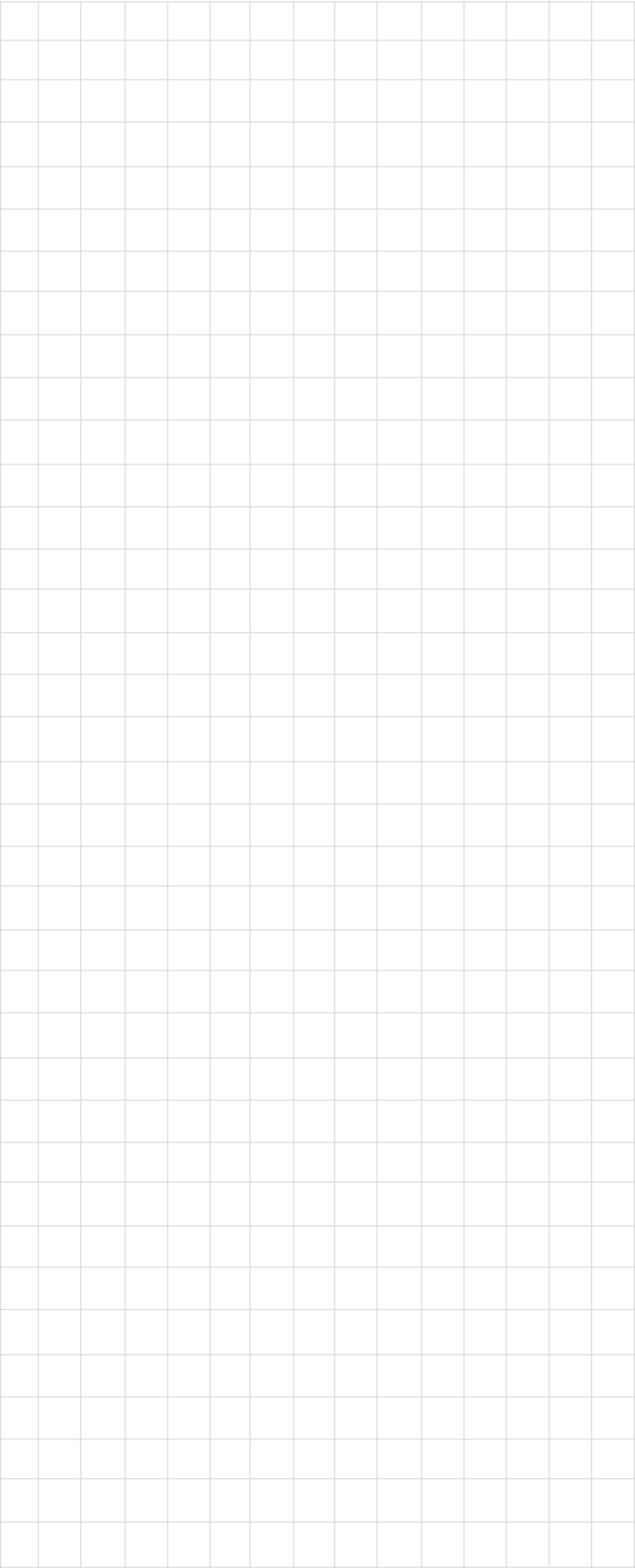

Specifications

System Driver Complement

Thirty 4 inch Midranges

Twenty-five 1 inch Dome Tweeters

Impedance

4 ohms Nominal

Frequency Response

80Hz - 20kHz

Sensitivity

88dB (2.8V/1m)

Crossover Frequency

1,700Hz

Power Handling

1200 Watts Maximum

Overall Dimensions

75-1/4 inches (191.14cm) Height

11-15/16 inches (30.32cm) Width

5-3/8 inches (13.65cm) Depth

Finish

Black Ash, Natural Cherry or Red Cherry

Weight

82 pounds (37.20kg) net

102 pounds (46.27kg) in shipping carton

Packing Instructions

In the event it is necessary to repack the equipment for shipment, the equipment must be packed exactly as received. Failure to do so will result in shipping damage.

Use the original shipping carton and interior parts only if they are in good serviceable condition. If a shipping carton or any of the interior part(s) are needed, please call or write Customer Service Department of McIntosh Laboratory.

High Frequency Section Column

Quantity	Part Number	Description
1	034203	Top shipping carton
1	034204	Bottom shipping carton
2	034205	Foam end cap
2	034206	Foam center cap

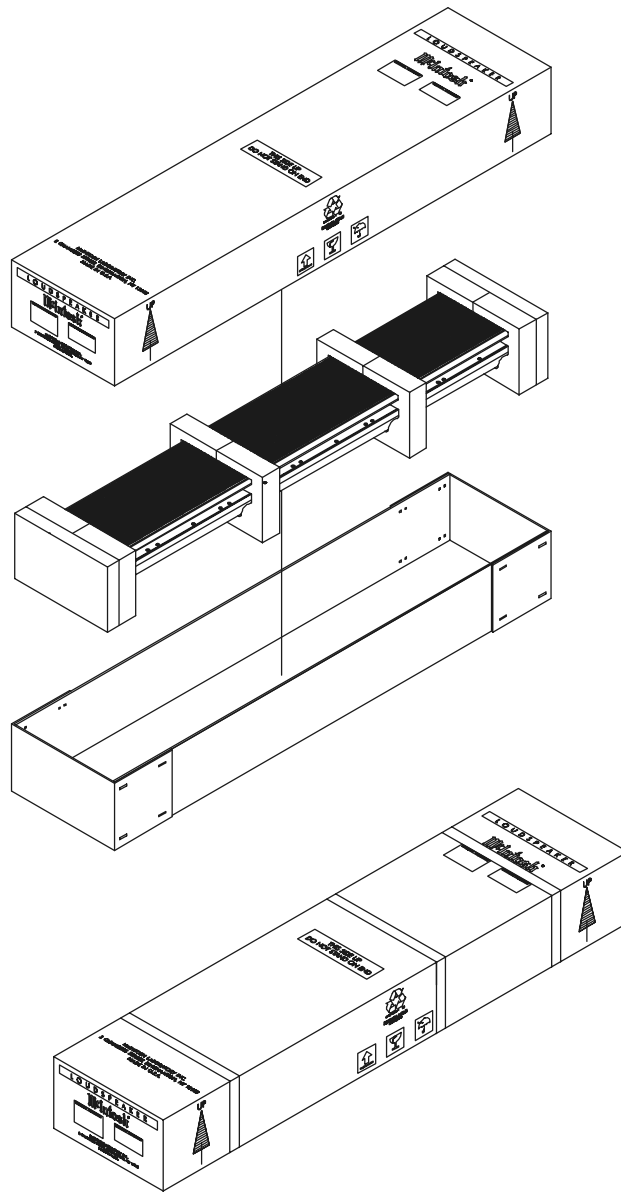



McIntosh Laboratory, Inc.
2 Chambers Street
Binghamton, NY 13903

McIntosh Part No. 04081401

See more at <http://safe-manuals.com>