



C 31V

AUDIO/VIDEO
CONTROL CENTER

McIntosh[®]

OWNERS MANUAL

IMPORTANT SAFETY INSTRUCTIONS

THESE INSTRUCTIONS ARE OFFERED TO PROTECT YOU AND THE McINTOSH INSTRUMENT. BE SURE TO FAMILIARIZE YOURSELF WITH THE FOLLOWING.

1. Read All Instructions - Read the safety and operating instructions before operating the instrument.
2. Retain Instructions - Retain the safety and operating instructions for future reference.
3. Heed Warnings - Adhere to warnings and operating instructions.
4. Follow Instructions - Follow all operating and use instructions.
5. Power Sources - Connect the power supply only to the type described in the operating instructions or as marked on the unit.
6. Power-Cord Protection - Route power-supply cords so that they are not likely to be walked on or pinched by items placed upon or against them, paying particular attention to cords at plugs, convenience receptacles, and the point where they exit from the instrument.
7. Ventilation - Locate the instrument for proper ventilation. For example, the instrument should not be placed on a bed, sofa, rug, or similar surface that may block the ventilation openings; or, placed in a built-in installation, such as a bookcase or cabinet, that may impede the flow of air through the ventilation openings.
8. Heat - Locate the instrument away from heat sources such as radiators, heat registers, stoves, or other appliances (including amplifiers) that produce heat.
9. Wall or Cabinet Mounting - Mount the instrument in a wall or cabinet only as described in the owners manual.
10. Water and Moisture - Do not use the instrument near water - for example, near a bathtub, washbowl, kitchen sink, laundry tub, in a wet basement, or near a swimming pool, etc.
11. Cleaning - Clean the instrument by dusting with a dry cloth. Clean the panel with a cloth moistened with a window cleaner.
12. Object and Liquid Entry - Do not permit objects to fall and liquids to spill into the instrument through enclosure openings.

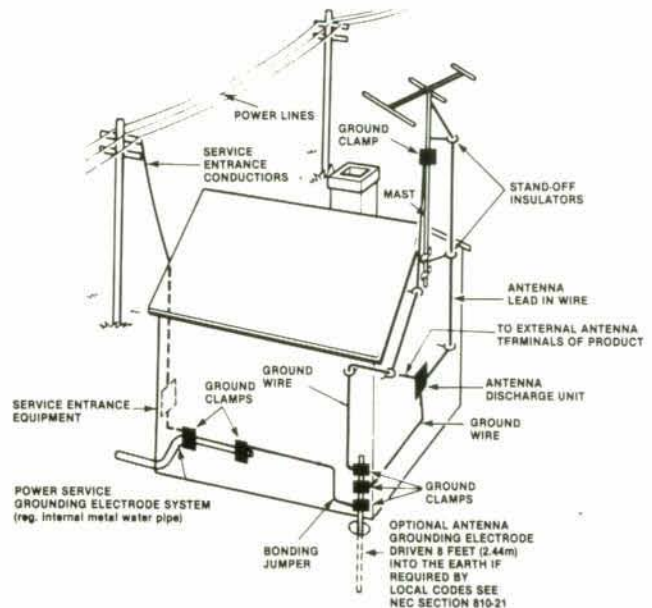

13. Power Lines - Locate any outdoor antenna away from power lines.
14. Outdoor Antenna Grounding - If an outdoor antenna is connected to the antenna terminal, be sure the antenna system is grounded so as to provide some protection against voltage surges and built up static charges.
In the U.S.A., section 810 of the National Electrical Code, ANSI/NFPA No. 70-1984, provides information on the proper ground for the mast and supporting structure, ground for the lead-in wire to an antenna discharge unit, and size of ground conductors, location of antenna-discharge unit, connection to grounding electrodes, and requirements for the grounding electrode.
For ground wire,
 - a) Use No. 10 AWG (5.3 mm²) copper No. 8 AWG (8.4 mm²) aluminum, No. 17 AWG (1.0 mm²) copper-clad steel, bronze wire, or larger as ground wire.
 - b) Secure antenna lead-in and ground wires to house with stand-off insulators spaced from 4 feet (1.22 meters) to 6 feet (1.83 meters) apart.
 - c) Mount antenna discharge unit as closely as possible to where lead-in enters house.
 - d) Use jumper wire not smaller than No. 6 AWG (13.3 mm²) copper or equivalent when separate antenna-grounding electrode is used.

- 15. Nonuse Periods - Unplug the power cord from the AC power outlet when left unused for a long period of time.
- 16. Damage Requiring Service - **Service must be performed by qualified service personnel when:**
 - A. The power-supply cord or the plug has been damaged; or
 - B. Objects have fallen, or liquid has been spilled into the instrument; or
 - C. The instrument has been exposed to rain; or
 - D. The instrument does not appear to operate normally or exhibits a marked change in performance; or
 - E. The instrument has been dropped, or the enclosure damaged.
- 17. Servicing - Do not attempt to service beyond that described in the operating instructions. All other service should be referred to qualified service personnel.

- 18. Grounding or Polarization - Do not defeat the inherent design features of the polarized plug. Non-polarized line cord adapters will defeat the safety provided by the polarized AC plug.
- 19. **CAUTION: TO PREVENT ELECTRIC SHOCK DO NOT USE THIS (POLARIZED) PLUG WITH AN EXTENSION CORD, RECEPTACLE OR OTHER OUTLET UNLESS THE BLADES CAN BE FULLY INSERTED TO PREVENT BLADE EXPOSURE.**

ATTENTION: POUR PREVENIR LES CHOCS ELECTRIQUES PAS UTILISER CETTE FICHE POLARISEE AVEC UN PROLONGATEUR, UNE PRISE DE COURANT OU UNE AUTRE SORTIE DE COURANT, SAUF SI LES LAMES PEUVENT ETRE INSEREES A FOND SANS EN LAISSER AUCUNE PARTIE A DECOUVERT.



The lightning flash with arrowhead, within an equilateral triangle, is intended to alert the user to the presence of uninsulated "dangerous voltage" within the product's enclosure that may be of sufficient magnitude to constitute a risk of electric shock to persons.



CAUTION: TO PREVENT THE RISK OF ELECTRIC SHOCK, DO NOT REMOVE COVER (OR BACK). NO USER-SERVICABLE PARTS INSIDE. REFER SERVICING TO QUALIFIED SERVICE PERSONNEL.



The exclamation point within an equilateral triangle is intended to alert the user to the presence of important operating and maintenance (servicing) instructions in the literature accompanying the appliance.

The serial number, purchase date, and McIntosh Laboratory Service Contract number are important to you for possible insurance claim or future service. Record this information here.

Serial Number

Purchase date

Service Contract Number

Upon application, McIntosh Laboratory provides a Service Contract to the original purchaser. Your McIntosh Authorized Service Agency can expedite repairs when you provide the Service Contract with the instrument for repair.

Contents

INTRODUCTION	3
INSTALLATION	4, 5
HOW TO CONNECT	6, 7, 8
FRONT PANEL CONTROLS	9, 10
PERFORMANCE LIMITS	11
PERFORMANCE CHARTS	12, 13
TECHNICAL DESCRIPTION	14
BLOCK DIAGRAM	15
SIMPLIFIED	
CONNECTING DIAGRAM	16

Your C 31V Audio/Video Control Center will give you many years of satisfactory performance. If you have any questions, please contact:

CUSTOMER SERVICE

McIntosh Laboratory Inc.
2 Chambers Street
Binghamton, New York 13903-9990
Phone: 607-723-3512

**Take Advantage of 3 years
of Contract Service...
Fill in the Application NOW.**

McINTOSH THREE YEAR SERVICE CONTRACT

An application for A THREE YEAR SERVICE CONTRACT is included with this manual.

The terms of the contract are:

1. Your application for the SERVICE CONTRACT must be filled in completely and postmarked within 30 days of the date of purchase of the instrument.
2. To receive the SERVICE CONTRACT, all information on the application must be filled in. The SERVICE CONTRACT will be issued when the completely filled in application is received by McIntosh Laboratory Incorporated in Binghamton, New York.
3. To receive the SERVICE CONTRACT, your purchase must be made from a McIntosh franchised dealer.
4. The SERVICE CONTRACT is issued to you as the original purchaser. To protect you from misrepresentation, this contract cannot be transferred to a second owner.
5. Any McIntosh authorized service agency will repair McIntosh instruments at normal service rates. To receive service under the terms of the SERVICE CONTRACT, the SERVICE CONTRACT CERTIFICATE must be presented when the instrument is taken to the service agency.
6. Always have service done by a McIntosh authorized service agency. If the instrument is modified or damaged as a result of unauthorized repair, the SERVICE CONTRACT will be cancelled. Damage by improper use or mishandling is not covered by the SERVICE CONTRACT.
7. McIntosh will provide all parts, materials and labor needed to return the measured performance of the instrument to the original performance limits. The SERVICE CONTRACT does not cover any shipping costs to and from the authorized service agency or the factory.
8. Units in operation outside the United States and Canada are not covered by the McIntosh Factory Service Contract, irrespective of the place of purchase. Units acquired outside the U.S.A. and Canada are also not covered, and these purchasers should consult with their dealer to ascertain what, if any, service contract or warranty may be available locally.

McIntosh has earned world renown for its technological contributions for improved sound. When you bought McIntosh, you bought not only high technology, you bought technological integrity proven by time. The McIntosh Audio/Video Control Center is the newest evidence of McIntosh technological integrity.

Music reproducing instruments that carry the McIntosh name have always been designed for technological leadership and to maintain the McIntosh reputation for best sound, for durability, and for long life. McIntosh has always earned the foremost reputation for quality performance. McIntosh has provided user oriented facilities and appearance and McIntosh design always provides for ease of maintenance or repair. These fundamental elements are incorporated in the McIntosh Audio/Video Control Center, yet it is easy to operate.

Your McIntosh C 31V Audio/Video Control Center, above all others will deliver to you the best sound, the most flexibility, and the greatest ease of use.

The C 31V is a superb quality, high performance Audio/Video control center. With the MVS-1 Video Selector, it will provide both audio and video control.

The C 31V has many useful features to enhance your listening and video enjoyment. They include:

High level inputs to accommodate the traditional as well as all the latest audio sources such as compact disc players and the high-quality audio from video recorders and laser video disc players.

A specially designed low noise switching system uses a pair of cascaded field effect transistors (FET) to operate the inputs. The input leads are very short, one-twentieth (1/20) of the length of previous designs. Advantages include, source-to-source isolation, lower distortion, and freedom from hum, noise, and interference from high-power TV and radar signals.

Any one of nine input sources can be selected using electronic switching. These inputs identified as Compact Disc, LASER disc, TV, TUNER, PHONO, AUX 1, AUX 2, VCR/T1, and VCR/T2.

Electronic tape monitor switches for two audio tape recorders, or the audio from two video recorders, or one audio recorder and the audio from one video recorder, allow either recorder to be heard from the main output.

Volume is adjusted by an electronically switched, precision, ladder attenuator. To achieve the desired level of volume, C² MOS transistors select from highly accurate deposits of resistive material.

Left/right tracking accuracy is controlled to a fraction of a dB. Noise potential, any misalignment and potential performance compromise are eliminated by a design which uses no moving parts. Unlike ordinary, quality degrading, electronic volume controls, the McIntosh precision ladder attenuator maintains the distortion-free, low-noise performance of the C 31V.

Two SPEAKER touchbuttons switches two sets of loudspeakers (when used with the optional SCR 3 speaker control relay) or two additional power amplifiers, which can provide program to other listening areas.

The preceding facilities and more may be selected and controlled by either the touchbuttons on the front panel or the hand-held infrared remote control. Additionally, remote control can be extended to two additional listening areas by the installation of McIntosh remote sensors which are easily connected by RG59U cable.

An active circuit loudness control is electrically independent of the volume control. Close conformity to the Fletcher-Munson equal loudness curves can be attained regardless of the volume setting.

A five-band program equalizer permits the adjustment and improvement of the loudness contrast of the five most important frequency ranges. Musical balance of source material can be adjusted to compensate for room recording differences or listener preferences.

Rear panel signal switching jacks provide output and input facilities for signal processing equipment. Processors may be used independently to modify a tape recording or the listened to program.

A built-in headphone amplifier provides power to the front panel headphone jack. All front panel controls are available to influence private listening on headphones.

Electronically regulated power supplies maintain stable operation during periods of changing line voltage.

This outstanding C 31V Audio/Video control center will serve you best when you understand its functions and what it is designed to do. Some time invested in reading this manual will be valuable in obtaining the most from your C 31V.

INTRODUCTION 3

The C 31V may be installed in a McIntosh cabinet or custom installed in furniture of your choice. Always provide adequate ventilation. Never place it above heat generating components such as high powered amplifiers. Provide 1½ inches (3 cm) of space above the preamplifier so as not to interfere with a cooling air flow.

CUSTOM INSTALLATION

The PANLOC system of installing equipment conveniently and securely, is a product of McIntosh research. Turned clockwise, the PANLOC buttons on the front panel lock the unit firmly in place. A counterclockwise turn of the PANLOC buttons unlocks the chassis from its mounting.

To install the instrument in a McIntosh cabinet, follow the instructions that are enclosed with the cabinet. For any other type of installation follow these instructions:

1. Unpack from Carton

Open the carton and remove the PANLOC brackets, hardware package, and mounting template. Remove the instrument from its plastic bag and place it upside down on the shipping pallet. Unscrew the four plastic feet from the bottom of the chassis and unscrew and remove the transit screws. Unless the transit screws are in place when the instrument is transported, damage can occur. Keep the transit screws in a safe place.

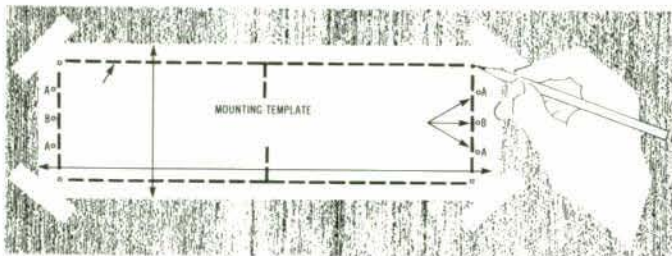

2. Mark the Cabinet Panel.

Tape the mounting template in position on the cabinet panel where the instrument is to be installed. The broken lines that represent the outline of the rectangular cutout also represent the outside dimensions of the chassis. Make sure these lines clear shelves, partitions, or any equipment. With the template in place, first mark the six A and B holes and the four small holes that locate the corners of the cutout. Then, join the four corner markings with pencil lines, using the edge of the template as a straightedge.

3. Drill Holes

Use a drill with a 3/16 inch (5 mm) bit held perpendicular to the panel and drill the six A and B holes.

Then, using a drill bit slightly larger than the tip of your saw blade, drill one hole at each of two diagonally opposite corners. The holes should barely touch the inside edge of the penciled outline. Before taking the next step, make sure that the six A and B holes have been drilled.

4. Saw the Panel Cutout

Saw carefully on the inside of the penciled lines. First make the two long cuts and then the two short cuts. After the rectangular opening has been cut out, use a file to square the corners and smooth any irregularities in the cut edges.

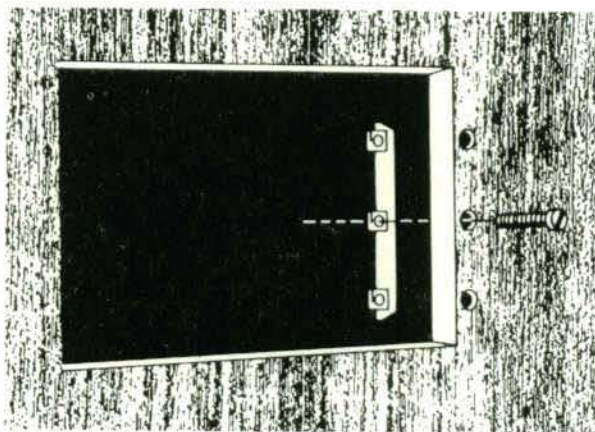

5. Install the Mounting Strips

In the hardware package you will find two mounting strips, and two sets of machine screws. For panels that are less than 1/2 inch (12.7 mm) thick, use the 3/4 inch (19.1 mm) screws; for panels that are more than 1/2 inch (12.7 mm) thick, use the 1-1/4 inch (31.8 mm) screws.

Starting at the right-hand side of the panel, insert a screw of the proper length into the center hole in the panel, marked B on the template. On the back of the panel, align a mounting strip with the holes in the panel and tighten the screw until the screwhead is pulled into the wood.

Repeat this procedure to attach the mounting strip to the left side of the panel.

6. Attach the PANLOC Brackets

Using two screws of the proper length in the A holes on each side, attach the PANLOC brackets to the cabinet panel; the short flange is mounted against the front (face) of the cabinet panel. The screws pass through the PANLOC bracket flange, the cabinet panel, and then through the mounting strips previously mounted.

4 INSTALLATION

INSTALLATION 5

7. Install the Instrument
Guide the AC power cord through the panel opening to the back of the cabinet; then, slide the instrument into the opening carefully so that the rails on the bottom of each side of the chassis engage the tracks on the mounting brackets. Continue to slide the instrument into the cabinet until the front panel is flush with the cabinet panel. Turn the PANLOC buttons at the lower left and right corners of the instrument panel clockwise to lock the unit firmly in the cabinet. Turn the PANLOC buttons counterclockwise to unlock the instrument. It can then slide outward to permit the removal.

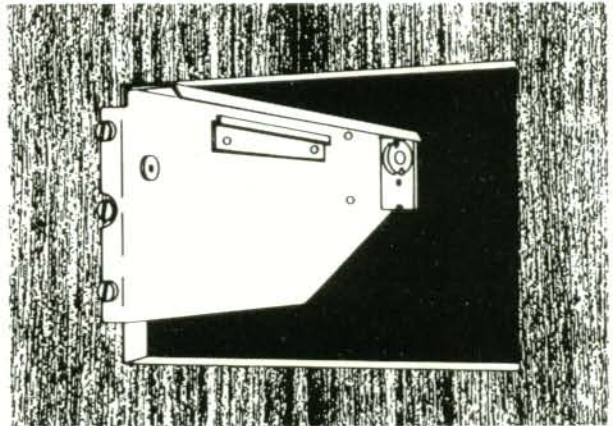

The back cover folds out to show photographs of the front and rear panels of the C 31V. Fold it out to assist you in locating the connectors. The numbers refer to the paragraphs that follow.

There are three fields of audio connectors on the back panel of the C 31V for use with associated equipment: AUDIO INPUTS, EXTERNAL PROCESSORS, and AUDIO OUTPUTS. On the front panel is an additional phone jack for use with headphones.

Use shielded cables to interconnect the source equipment and the preamplifier. To minimize the possibility of hum or noise, the shielded cables should be of parallel construction or, if not, loosely twist the left and right cables together. Locate them away from the speaker connecting cables and AC power cords. Be certain to use good quality shielded cables for all interconnections. Your dealer can advise you on the kind and length of cable that will best suit your installation.

The first field of connectors is marked:

AUDIO INPUTS

1. PHONO:

Connect the cable from the turntable left channel to the Left PHono INPUT. Connect the cable from the turntable right channel to the Right PHono INPUT. If the turntable has a separate ground lead, connect it to the screw terminal marked ground (GND).

2. CD:

Connect the cable from the Compact Disc (CD) player left channel output to the Left CD INPUT. Connect the cable from the CD player right channel output to the Right CD INPUT.

3. LASER VISION PLAYER:

The audio from a laser vision video disc player can be connected to the LASER INPUT. Connect the cable from the left channel audio output of a laser disc player to the Left LASER INPUT. Connect the cable from the right channel audio output of a laser disc player to the Right LASER INPUT.

4. TV:

Audio from a stereo TV set or TV monitor can be connected to the TV INPUT. Connect the left channel cable to the Left TV INPUT. Connect the right channel cable to Right TV INPUT.

The output of a monophonic TV set can be connected to both left and right channel TV INPUTS by use of a "Y" connector.

5. TUNER:

Connect the cable from the tuner left channel output to the Left TUNER INPUT. Connect the cable from the tuner right channel output to the

Right TUNER INPUT.

6. AUX 1 AND 2:

Audio from any high level source is connected to AUX 1 or 2 INPUTS. Connect a cable from the left channel audio output of a TV monitor or other high level source, to the L AUX 1 INPUT jack. Connect a cable from the right channel audio output to the R AUX 1 INPUT jack. AUX 2 may be used in a similar manner.

7. VCR 1/TAPE 1:

For tape playback or to monitor while recording: connect the cable from the tape recorder left channel output to the Left VCR 1/TAPE 1 INPUT. Connect the cable from the tape recorder right channel output to the Right VCR 1/TAPE 1 INPUT. Connect a second recorder in the same manner to the VCR 2/TAPE 2 INPUT.

Video Tape Recorders: If you prefer, one or both of the VCR/TAPE INPUTS can be used for the audio from a VCR. Connect the left channel audio output from the VCR to the Left VCR 1/TAPE 1 INPUT. Connect the right channel audio output from the VCR to the Right VCR 1/TAPE 1 INPUT. If the VCR has only a single audio output (mono), use a "Y" connector to connect the program to both the left and right input.

The second field of connectors is marked:

EXTERNAL PROCESSORS

8. EXTERNAL PROCESSORS — TAPE

There are two sets of EXTERNAL PROCESSOR jacks, one set that affects the program fed to the VCR/TAPE 1 and 2 OUTPUT jacks and one set that affects the program fed to the AUDIO OUTPUTS MAIN and SWITCHD 1 and 2 jacks. Use the EXTERNAL PROCESSOR jacks to add a noise reduction or any audio signal processing device. Be sure to match the left to left and right to right channels when connecting external processors.

The EXTERNAL PROCESSOR jacks have switching contacts which allow the signal to pass through them when nothing is plugged into the jacks. When an external processor is used, the program is routed to the external processor from the EXTERNAL PROCESSOR TO jack and back by the EXTERNAL PROCESSOR FROM jack.

WHEN AN EXTERNAL PROCESSOR IS USED, IT MUST BE TURNED ON FOR THE PROGRAM TO BE HEARD THROUGH THE SYSTEM.

6 HOW TO CONNECT

The third field of connectors is marked:

AUDIO OUTPUTS

9. VCR 1/TAPE 1 and VCR 2/TAPE 2

To record VCR audio or audio tape, connect a cable from the Left VCR 1/TAPE 1 OUTPUT to the left high-level input of the recorder. Connect a cable from the Right VCR 1/TAPE 1 OUTPUT to the right input of the recorder. Connect a second recorder in the same manner to the VCR 2/TAPE 2 OUTPUT.

10. MAIN:

Connect a cable from the left C 31V MAIN OUTPUT jack to the left power amplifier input jack.

Connect a cable from the right MAIN OUTPUT jack to the right power amplifier input jack.

11. SWITCHED 1 and 2:

Two additional stereo power amplifiers may be connected to the AUDIO OUTPUT SWITCHED 1 and 2 jacks. Audio output signal is supplied to these jacks only when the front panel touchbutton SPEAKER 1 and/or 2 touchbuttons are pressed. This arrangement is useful for large systems where separate amplifiers and loudspeakers are used at remote locations.

Additional amplifiers can serve remote areas such as selected living areas, workshop, or outdoor recreational facilities. Other devices can be controlled such as a rear channel reverberation unit.

12. GND (ground):

The ground (GND) post on the rear panel is provided primarily for a turntable or record changer that has a separate ground lead in addition to the signal leads.

13. AC POWER:

Plug the preamplifier AC power cord into a 120 volt 60 Hz wall outlet. The plug blades are polarized so be certain the plug is fully inserted in the outlet to prevent blade exposure.

CAUTION: TO PREVENT ELECTRIC SHOCK, DO NOT USE THE (POLARIZED) PLUG ON THIS UNIT WITH AN EXTENSION CORD, RECEPTACLE, OR OTHER OUTLET UNLESS THE BLADES CAN BE FULLY INSERTED TO PREVENT BLADE EXPOSURE.

Two types of AC power outlets are provided on the back panel of the C 31V. One is red, the rest are black.

The black outlets are switched on or off when the C 31V is turned on or off. Use these to provide AC power to amplifiers, CD players, or other ac-

cessories. The power capacity of all the outlets, totalled, is 1500 watts. For power consumption above 1500 watts, it is necessary to add a McIntosh SCR 3 (SPEAKER CONTROL RELAY). The SCR 3 has two AC power outlets that provide additional capacity of 1800 watts switched on or off by the C 31V. Use these outlets to supply AC power to amplifiers or other components whenever the total load to be switched exceeds the C 31V rating of 1500 watts.

The red outlet is on at all times and is used with accessories that have their own power switches. For example, a VCR plugged into this outlet will be able to record TV programs when the main audio system is turned off.

14. SCR (optional accessory):

The SPEAKER CONTROL RELAY (SCR 3) is designed to provide both AC outlet switching and speaker control switching.

The SCR 3 has two AC power outlets that provide additional capacity of 1800 watts which is controlled by the AC power switch on the C 31V. Use these outlets to supply AC power to amplifiers or other components when the total load switched exceeds the C 31V rating of 1500 watts. Plug the computer-type connector on the cable attached to the SCR 3 into the SCR socket on the rear of the C 31V. Plug the SCR 3 heavy, AC power line cord directly into a wall outlet. *Do not plug it into the C 31V.* When the C 31V is turned on, a control voltage from the C 31V will energize a relay in the SCR 3 which connects the two SCR 3 AC outlets directly to the wall outlet.

Two loudspeakers can be turned on or off with the SCR 3 by using the C 31V front panel touchbuttons SPEAKER 1 and 2. Use the TO MAIN SPEAKERS terminal strip on the SCR 3 to connect the main listening pair of speakers and TO REMOTE SPEAKER terminal to a remote area pair of speakers. Connect the power amplifier output to FROM POWER AMPLIFIER terminal strip. Maintain left and right orientation and like polarity. Touchbutton SPEAKER 1 will turn the main speakers on or off and SPEAKER 2 touchbutton will turn the remote speakers on or off.

15. TUNER:

A multipin computer-type connector is provided to interconnect the C 31V with McIntosh tuners designed for infrared remote control. When so connected, the HR 31V remote control will operate the normal functions of the tuner.

With this system, you can turn on the tuner,

select from the preprogrammed stations, search sequentially the programmed stations, or scan the entire broadcast band on either the AM or FM band. And raise or lower volume in the local area without affecting any other area.

16. VIDEO SELECTOR: (optional accessory)

The McIntosh VIDEO SELECTOR, MVS-1, is designed to enable the C 31V to control video programs as well as audio. The MVS-1 connects to the VIDEO SELECTOR computer-type connector on the rear of the C 31V. Follow the instructions with the MVS-1 for connecting the video cables.

17. AREA CONTROLLER: (optional accessory)

Adding the optional McIntosh CR 9 AREA CONTROLLER to the C 31V provides independent remote control facilities in a second area. The second area source can be selected and the volume adjusted independently of and without interference with the main area controlled by the C 31V. Additional independent remote control areas, up to a total of five, can be added by interconnecting a McIntosh CR 8 Remote Controller for each area in which remote control is desired.

CD:

A DIN connector is provided to interconnect the C 31V with a McIntosh Compact Disc player. When so connected, the HR 31V remote control for the C 31V will operate these functions of the Compact Disc player:

- 1) turn the player on or off
- 2) play a disc
- 3) move to the next track
- 4) back up a track
- 5) raise or lower the volume in the local area, or
- 6) mute the program without affecting any other area.
- 7) stop the playing of the disc.

SENSORS 1 and 2: (optional accessory)

Connectors are provided to add two additional McIntosh R 607 infrared sensors. This added convenience permits complete control of the stereo system from areas remote to the location of the C 31V. Remote sensors are interconnected with RG59U antenna cable.

INSERTING THE BATTERIES IN THE HR 31V REMOTE CONTROL

Your McIntosh C 31V Audio/Video Control Center is complete including Remote Control. In your hand, you have the ability to control all functions of the preamplifier with the exception of these controls: Loudness,

Balance, VCR/COPY, MONO mode selection and Equalizer. These can only be changed by use of the front panel controls.

The remote control runs on two AA, 1.5 volt batteries. Slide open the cover on the back of the remote control and insert the batteries as shown in the diagram in the battery compartment then slide the cover closed again.

Battery life is normally about one year. Remove the batteries as soon as they are dead to prevent damage by possible battery leakage or in case the remote control is not to be used for a length of time.

8 HOW TO CONNECT

The back cover folds out to show photographs of the front and rear panels of the C 31V. Fold it out to assist you in identifying and locating on the photographs the controls. The letters refer to the paragraphs that follow

The glass upper half of the C 31V front panel is the message center. It illustrates the source, volume setting, mode of operation, tape facilities in use, and connected operating speakers. The infrared sensor which accepts information from the HR 31V hand-held remote control is on the left of the vertical column VOLUME indicator.

The black anodized aluminum lower half contains the touchbuttons for:

- 1) source selection
- 2) mute
- 3) audio and video tape selection (video capability with accessory McIntosh MVS-1 Video Switcher)
- 4) stereo or mono mode selection
- 5) two area speaker switching (with the accessory SCR 3), and
- 6) on/off AC power.

These functions can be activated by the H 31V infrared remote control. The five EQUALIZER FREQUENCY controls, BALANCE, and LOUDNESS controls have been retained as rotating knobs to provide a high degree of repeatability. A headphone jack, the VOLUME up ▲ and down ▼ touchbuttons, and PANLOC locking buttons complete the front panel controls.

A. POWER:

The red touchbutton on the C 31V and the POWER button on the remote control turn the AC power on or off. When turned on, the message center will display (illuminate) the source that has been selected, any special operating modes, and the VOLUME setting.

Selecting a source:

To listen to a desired source (CD, TUNER, etc), touch either the corresponding front panel touchbutton or the HR 31V remote control button. The indicator in the message center for that touchbutton will light.

B. MUTE:

Should you desire to silence the system briefly, touch the MUTE button on either the C 31V or the remote control. A red LED above the MUTE touchbutton will light, and the program will be silenced at the MAIN and SPEAKER 1 and 2 AUDIO OUTPUTS only. MUTE DOES NOT AFFECT THE TAPE OUTPUTS.

C. MONITOR:

IMPORTANT: When the C 31V is operated in MONITOR mode with VCR/T1 or VCR/T2 lighted in the message center, the program heard will be that from the tape recorders only. Any other source will not be heard from the loudspeakers.

The C 31V is designed to be used with two tape recorders, either audio or video, or one audio and one video recorder.

The MONITOR switches are electronically interlocked to prevent simultaneous monitoring from two tape recorders.

The four touchbuttons, MONITOR VCR/T1, VCR/T2, VCR/T COPY, 1 ► 2, 2 ► 1, control the signal in and out of these recorders. They permit recordings to be monitored while recording, or copying of tapes and listening to a separate program or the playback of either recorder.

MONITOR VCR/T1 touchbutton: When VCR/T1 is lighted in the message center, signal from a tape recorder plugged into INPUT VCR/TAPE 1 is fed to the power amplifiers and heard through the loudspeakers.

MONITOR VCR/T2 touchbutton: Functions similarly to MONITOR VCR/T1.

D. VCR/T COPY:

1 ► 2 touchbutton: connects the output from tape recorder 1 to the input of tape recorder 2 and lights 1 ► 2 in the message center without affecting the program being heard from the speakers. In this position, a copy of the program on tape recorder 1 can be made on tape recorder 2. To monitor the original, use MONITOR VCR/T1 touchbutton and to monitor the copy, use MONITOR VCR/T2 touchbutton.

2 ► 1 touchbutton: connects the output from tape recorder 2 to the input of tape recorder 1 and lights 2 ► 1 in the message center without affecting the program being heard from the speakers. In this position, a copy of the tape program on recorder 2 can be made on recorder 1. To monitor the original, use MONITOR VCR/T2 touchbutton and to monitor the copy, use MONITOR VCR/T1 touchbutton.

E. MONO:

The MONO touchbutton adds the left and right program together to provide a monophonic program at the MAIN and SPEAKER 1 and 2 AUDIO OUTPUTS only, and the MONO indicator in the message center will light. MONO does not affect the TAPE OUTPUTS.

F. SPEAKER 1 and 2

The SPEAKER 1 and 2 touchbuttons can be used to

switch on or off either the SWITCHED 1 and 2 AUDIO OUTPUTS jacks or the main and remote speakers when an optional SPEAKER CONTROL RELAY (SCR 3) is used.

The SWITCHED 1 and 2 jacks on the rear panel of the C 31V have the same program as the MAIN OUTPUT. When one or both SPKR1 or SPKR2 indicators are lighted in the message center, the program is connected to the corresponding AUDIO OUTPUTS jacks.

Program to other devices can be controlled such as rear channel delay, reverberation, etc. Example: connect the SWITCHED 1 jack to the input of a reverberation device and the output of the reverberation device to the input of an amplifier and the output to a set of rear loudspeakers. Rear channel reverberation can then be switched on or off by the SPEAKER 1 touchbutton.

G. HEADPHONES:

The HEADPHONES jack has been designed to feed low impedance dynamic headphones. An amplifier in the C 31V provides the necessary power for the HEADPHONES jack.

H. EQUALIZER FREQUENCY:

Each of five EQUALIZER FREQUENCY controls raises or lowers the amplitude of a band of frequencies centered on the frequency marked above the control. Both left and right channels are affected. The center, or flat position, of the control has a detent for easy reference. In the center or detent position, the entire circuit for that control is remoted from the program circuit by grounding the control electronically. The result is a preamplifier that is a "straight wire with gain" or one that has the ability to satisfy the musical balance to your taste.

Use the EQUALIZER FREQUENCY controls to modify the sound and balance of program material.

Adjustment to	Equalizer Correction
Make deep bass louder	Raise 30
Make all bass louder	Raise 30 and 150
Reinforce voices	Lower 150 and raise 500
Hum on program	Reduce 30 and 150
Brighten violins and trumpets	Raise 1500
Emphasize cymbals	Raise 10 K

I. BALANCE

The BALANCE and LOUDNESS controls are concentric. The BALANCE control (large outer knob) adjusts the volume of the channels relative to each other.

L-left...turning the control to the left accents the left channel by reducing the right channel output.

R-right...turning the control to the right accents the right channel by reducing the left channel output.

J. LOUDNESS

The LOUDNESS control (small center knob) provides frequency response contoured to compensate for the behavior of the human ear at lower listening levels. This contour is accurately modeled after the family of "equal loudness" curves identified by Fletcher and Munson. At the fully counterclockwise detented FLAT position, the loudness contour is electrically flat. As the control is turned clockwise, both bass and treble frequencies increase in the correct proportion. The contour is not affected by changes of VOLUME. After adjusting VOLUME for the desired listening level, adjust the LOUDNESS control for the preferred compensation.

K. VOLUME:

Volume may be adjusted by using the VOLUME ▲ or VOLUME ▼ on the front panel on the remote control. Adjustment of the volume is performed by an electronically switched, precision, ladder attenuator. To provide volume adjustment, highly accurate deposits of resistive material are selected C² MOS transistors. The entire range of volume adjustment is 68 dB in 2 dB increments. Left and right tracking is controlled to a fraction of a dB. Because there aren't any moving parts, the volume adjustment cannot generate noise or misalignment. Unlike ordinary electronic volume controls, the McIntosh precision ladder attenuator supports the distortion-free, low-noise performance of the C 31V.

The VOLUME indicator in the message center is a segment vertical display. As volume is increased, more segments are lighted to indicate relative volume..When the AC power is turned on, the last volume setting will be displayed.

L. PANLOC:

McIntosh developed PANLOC mounting brings professional installation technique to home stereo systems. Then the front panel PANLOC buttons turn clockwise to lock the unit into the cabinet. Turning the PANLOC buttons again counterclockwise unlocks the C 31V, allowing it to be removed.

10 FRONT PANEL CONTROLS

PERFORMANCE LIMITS

Performance limits are the maximum deviation from perfection permitted for a McIntosh instrument. We promise you that when you purchase a new C 31V from a McIntosh franchised dealer, it will be capable of or can be made capable of performance at or exceeding these limits or you can return the unit and get your money back. McIntosh is the only manufacturer that makes this statement.

FREQUENCY RESPONSE

+0, -0.5dB from 20Hz to 20,000Hz

MAXIMUM VOLTAGE OUTPUT

Main and Tape Output- 8V from 20 to 20,000Hz

TOTAL HARMONIC DISTORTION

0.007% maximum from 20 to 20,000Hz at 1.5V rated output.

SENSITIVITY

Phono- 2mV for 1.5V rated output (0.66mV IHF)

High Level- 200mV for 1.5V rated output (66mV IHF)

SIGNAL TO NOISE RATIO, A-WEIGHTED

Phono- 90dB below 10mV input (84dB IHF)

High Level- 98dB below rated output (88dB IHF)

MAXIMUM INPUT SIGNAL

Phono- 90mV

High Level- 10V

INPUT IMPEDANCE

Phono- 47k ohms and 65pF capacitance

High Level- 22k ohms

VOLTAGE GAIN

Phono to Tape- 40dB

Phono to Main- 62dB

High Level to Tape- 0dB

High Level to Main- 17.5dB

EQUALIZATION CONTROLS

Variable 12dB boost to 12dB cut at center frequencies of 30, 150, 500, 1500, 10kHz

GENERAL INFORMATION

SEMICONDUCTOR COMPLEMENT

47 Bipolar Transistors

65 Field Effect Transistors

37 Integrated Circuits

106 Diodes

AC POWER OUTLETS

7 black, switched, and 1 red, unswitched, 1200 watts total capacity

POWER REQUIREMENTS

120 volts, 50/60Hz, 25 watts

MECHANICAL INFORMATION

SIZE:

Front panel measures 16 1/8 inches wide (41 cm) by 5 7/16 inches high (13.8 cm) by 13 inches deep (33 cm), including connectors. Knob clearance required is 1 1/4 inches (3.18 cm) in front of mounting panel.

FINISH:

Front panel is glass with gold/teal nomenclature illumination with anodized gold and black aluminum. Chassis is black.

MOUNTING:

Exclusive McIntosh developed professional PANLOC.

WEIGHT:

16.5 pounds (7.5 kg) net, 28.5 pounds (12.9 kg) in shipping carton.

EQUALIZER FREQUENCY RESPONSE CONTROLS
SET AT MAXIMUM AND MINIMUM

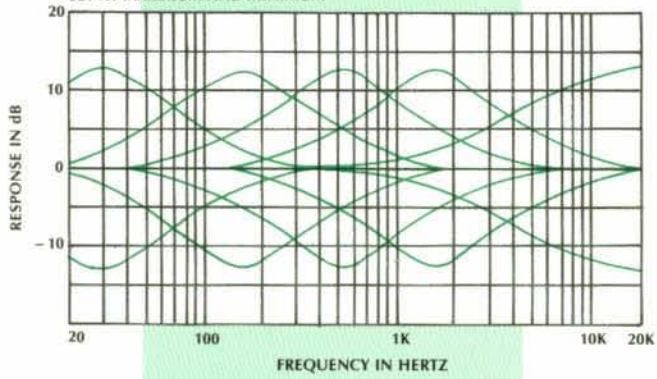

LOUDNESS CONTROL RESPONSE
FOR VARIOUS CONTROL POSITIONS

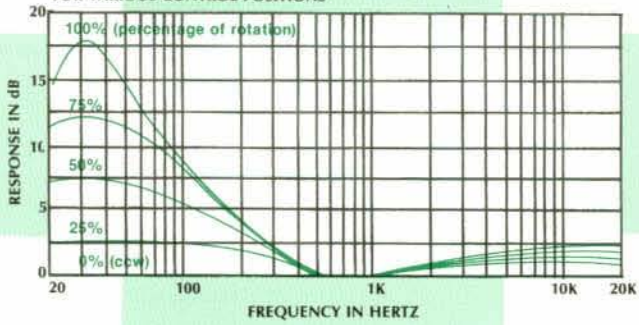

FREQUENCY RESPONSE
— HIGH LEVEL IN
TO MAIN OUT

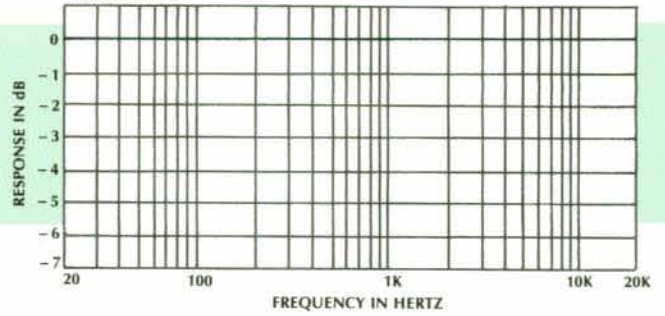

12 PERFORMANCE CHARTS

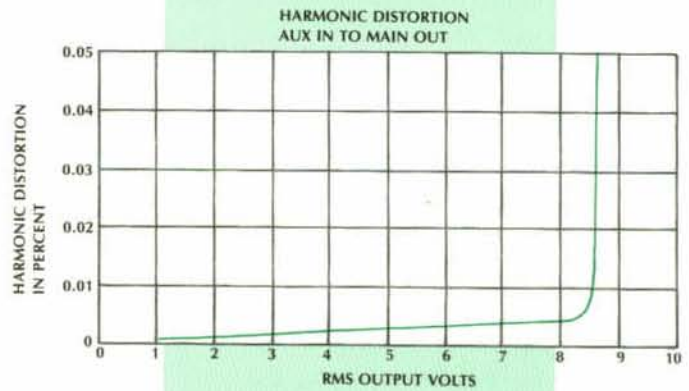
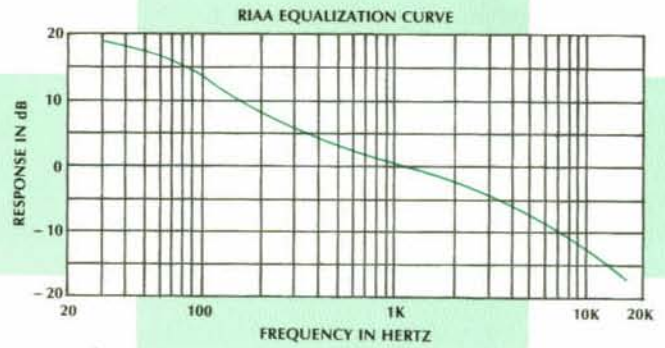

FULL ELECTRONIC SWITCHING

All input switching including tape, tape-to-tape, and mono is done electronically using J-FET field effect analog switches. All the front panel switches control small amounts of DC voltage which turn the FET analog switches on and off. The critical audio signals are switched silently with instantaneous muting between switch positions. No transient switching noises or pops are present with this superior design.

PHONO AMPLIFIER

The phono amplifier uses a high technology integrated circuit operational amplifier. Its differential input stage has been optimized for low noise and low distortion performance. Open loop gain of this integrated circuit is 100,000. With high open loop gain, a large amount of negative feedback can be used around the phono amplifier to further reduce noise and distortion. The feedback network also provides precision RIAA frequency compensation. The network uses 1% metal film resistors and 5% poly film capacitors. To achieve low-noise performance, it is essential that the feedback network be very low impedance. As a consequence, the preamplifier must be capable of operating as a power amplifier to drive this impedance. The actual power output capability of this preamplifier stage is more than 100 milliwatts, a great margin beyond that which is required.

Input sensitivity of the phono amplifier is 2 millivolts. The gain of the amplifier is 40dB at 1000Hz. The phono amplifier has a very wide dynamic range. At 1000Hz, the phono input circuit will accept 80 millivolts without overload, a voltage far greater than the output of any current magnetic phono cartridge. Phono input overload, therefore, is virtually impossible. A signal level of 10 millivolts at the phono input at 1000Hz will produce 1 volt at the tape output. The tape output has a source impedance of 200 ohms, designed to operate into a load impedance of 10,000 ohms or greater.

HIGH LEVEL AMPLIFIER

At the input to the high level or loudness amplifier, the signal passes through the electronic mono switch, then through the electronic volume control, and into the amplifier. In the past, loudness controls have typically used simple passive circuits connected to a tap on the volume control. As a consequence, compensation accuracy was dependent on many variables such as volume control position and differences in input level. The C 31V uses active circuitry. The same type of integrated circuit operational amplifier that is used in the phono amplifier is used here. It has two feedback loops. One feedback loop has flat response. The other feed-

back loop conforms to the Fletcher-Munson equal loudness compensation. A potentiometer is placed between these two feedback loops making it possible to select any combination of the two from a flat response to full loudness compensation. The overall gain of the volume and loudness stages is 17.5dB and is not affected at mid frequencies by the position of the loudness control.

EQUALIZER AMPLIFIER

The equalizer amplifier uses high technology integrated circuit operational amplifiers. Its output stage has been optimized for the best transient performance and minimum distortion. Four other operational amplifiers are each arranged in a circuit configuration that is the equivalent of series tuned circuits, one at each of the five center frequencies. Each series tuned circuit is inserted via the control potentiometer in either the input circuit or feedback circuit of the operational amplifier, thereby, providing a boost and cut capability of 12dB for each band of frequencies. The overall gain of the stage is 0dB.

CONTROL LOGIC

All inputs, outputs, CD, Tuner, SCR, and Video Selector lines are controlled by logic circuits in the C 31V. The logic can be changed by front panel switches or the infrared remote control system in the C 31V. The infrared receiver's information comes from the remote transmitter HR 31. Input selection, volume level, speaker selection, power on/off can be made at the front panel or the remote transmitter. Mono and tape copy selections are made at the front panel. McIntosh tuners and CD's are controlled from the remote transmitter. A back-up 5.6 volt power supply keeps all selection when the C 31V power is turned off as long as 120 volts AC power is not interrupted.

14 TECHNICAL DESCRIPTION

McINTOSH C 31V AUDIO/VIDEO CONTROL CENTER

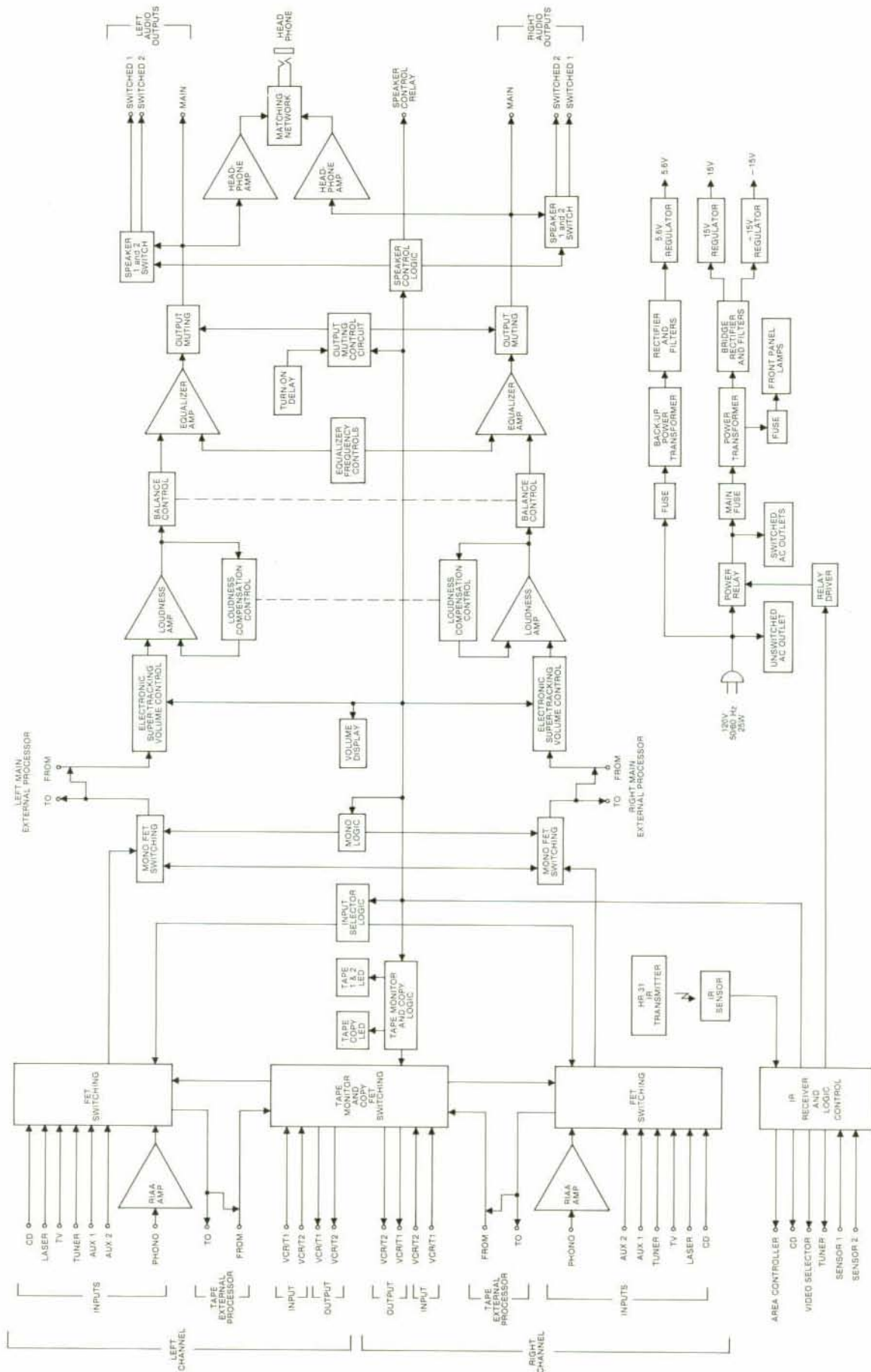

C 31V SIMPLIFIED CONNECTING DIAGRAM

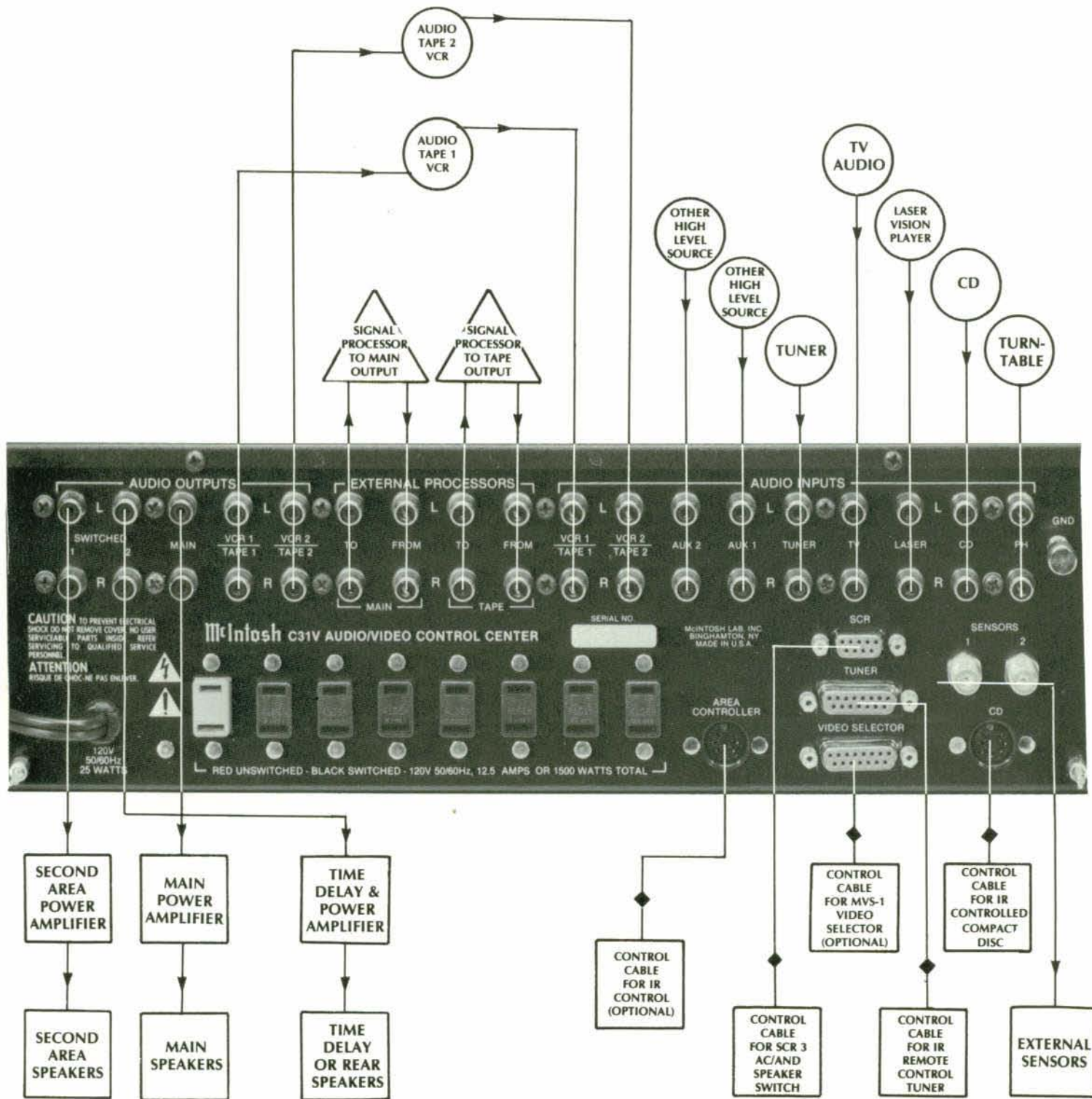

◆ CONTROL CABLE

16 CONNECTING DIAGRAM

THE LOCATION OF CONTROLS

The numbers and letters correspond to the paragraphs on pages 6, 7, 8, 9 and 10



McIntosh[®]

McINTOSH LABORATORY INC.
2 CHAMBERS ST., BINGHAMTON, NY 13903-2699
607-723-3512

The continuous improvement of its products is the policy of
McIntosh Laboratory Incorporated who reserve the right
to improve design without notice.
Printed in U.S.A.

039603