

**STEREO
PREAMPLIFIER**

C22

CONTENTS

GENERAL DESCRIPTION _____	1
TECHNICAL DESCRIPTION _____	1
Mechanical Specifications _____	2
Electrical Specifications _____	2
FRONT PANEL INFORMATION _____	3
INSTALLATION _____	8
CONNECTIONS _____	8
AC Connections _____	8
AC Power _____	9
Input Connections _____	9
Output Connections _____	10
Loudspeaker Phasing Connections _____	11
Ground Connection _____	11
OPERATING INSTRUCTIONS _____	11
GUARANTEE _____	16
3-YEAR FACTORY SERVICE CONTRACT _____	16

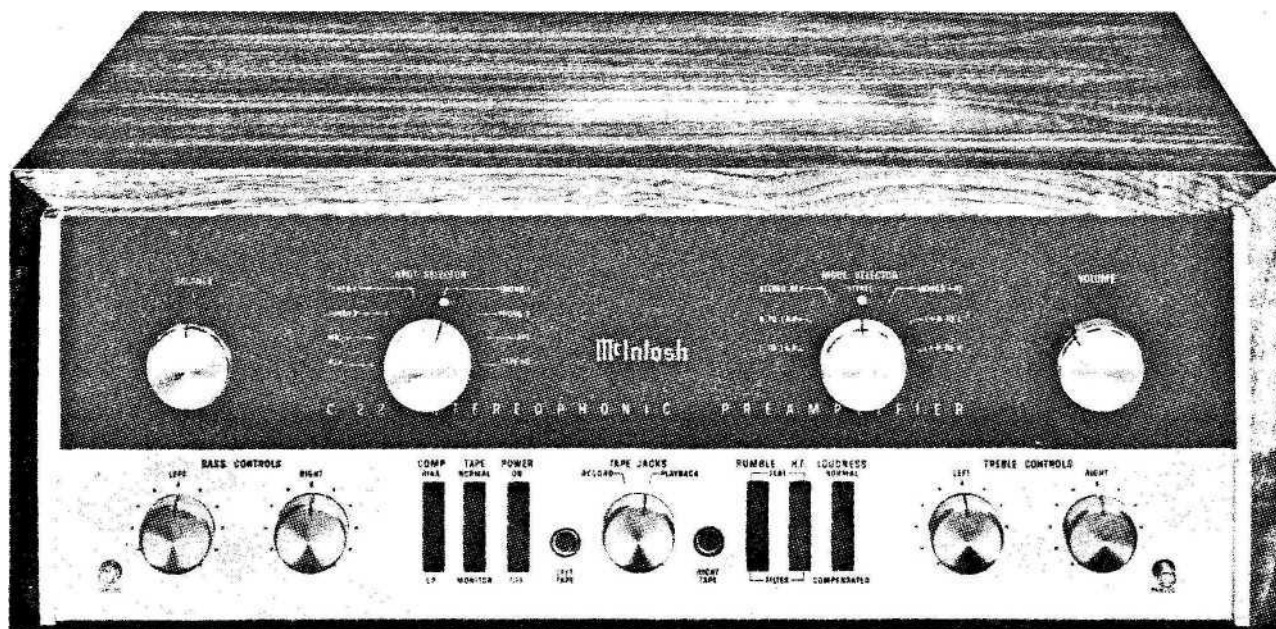

OWNER'S MANUAL

McIntosh
C 22

C22 STEREO PREAMPLIFIER

GENERAL DESCRIPTION

The McIntosh C22 Stereophonic Preamplifier is a control center for any stereophonic sound system. To increase your enjoyment of stereo, this control center does four jobs with precise control.

First, the control center amplifies weak electrical impulses. As the record rotates on the turntable, undulations in the grooves move the pickup stylus approximately one thousandth of an inch, in any direction, from the rest position. From this slight mechanical movement, the pickup stylus generates a weak electrical impulse on the order of a few thousandths of a volt. To amplify and preserve the information in such an electrical impulse, the finest amplifier performance is required.

Second, every sound system is used in a different acoustical environment. The tone balance of the music is affected by variations in environment. Also, people listening to the music have varying ideas of correct tone balance. To compensate for these conditions, a high-quality tone control center is needed.

Third, all stereophonic and monophonic records, both domestic and foreign, are recorded with specific frequency equalization. The control center must accurately compensate for this equalization introduced in the recording process.

Fourth, programs can originate from several sources such as tuners, records, tape machines, microphones, etc. A control center is needed to select and switch these sources separately or in combination.

All of these jobs are performed with excel-

lence by the C22.

The C22 also uses the new, exclusive McIntosh PANLOC method of installation. The PANLOC system gives you absolute ease of installation, operation, and maintenance. PANLOC is the first professional installation technique to be used on stereo instruments.

In the PANLOC system a metal shelf is mounted first, then the preamplifier slides into position on this shelf. Depressing the PANLOC buttons on the front panel locks the preamplifier firmly into place for normal operation. To unlock the preamplifier, depress the front panel PANLOC buttons a second time. The preamplifier can now slide forward to the ADJUST position. The preamplifier will lock in this position approximately 3 inches from the mounting panel. Now you can adjust the output level controls, low frequency trim controls, tape equalization controls, phase switch and pilot lamp intensity switch. These controls are mounted just behind the C22 front panel. Depressing the ADJUST position holding latches on the sides of the chassis allows the preamplifier to be taken out of the PANLOC shelf, or to slide back into position against the mounting panel.

Once you have enjoyed the outstanding performance of the C22, you will understand why McIntosh products have earned their reputation as "THE BEST." Your McIntosh C22 Stereophonic control preamplifier will give you years of the finest possible performance, and will become a highly valued part of your home music system.

TECHNICAL DESCRIPTION

The C22 Stereophonic Preamplifier combines excellence in performance with ease of operation. The most often used controls have large diameter knobs. A new type of rocker switch is used for the controls with simple on-off functions. The C22 has an illuminated front panel with a light intensity switch to

provide convenient reading under low-level lighting conditions. The Mode and Input Selector switch positions are also illuminated.

The C22 circuit consists of 3 amplifier sections in duplicate for the left and right stereo channels together with a common power supply. The first amplifier section is

the input preamplifier used to amplify and equalize signals from phonograph pickups, microphones or tape heads. Skillful circuit layout, proper grounding, and adequate shielding reduce the hum so low it is virtually unmeasurable. Extreme care in manufacturing combined with low noise tubes, high specific resistivity circuit boards, metal film and wire wound resistors achieves new low in residual noise.

The second amplifier section follows the main volume control, making it impossible to overload the high level input circuits or any following circuits. The same design techniques as used in the preamplifier section assure low noise and hum. The BASS and TREBLE feedback-type tone controls operate in connection with this amplifier section. The controls are switch-type with approximately 4 db change per step. Exceedingly low distortion and precise control of frequency response contours are assured using this arrangement.

Front panel tape jacks are provided for convenient use of an external tape machine. The TAPE JACK switch connects the jacks for either playback or recording through the C22.

The third section is the cathode follower output. The sharp cutoff (18 db per octave)

RUMBLE and HF (high frequency) filters are associated with this section. OUTPUT LEVEL controls are located at the inputs of the cathode followers to allow simple balance of the entire amplifier-speaker system. The OUTPUT LEVEL controls are located on top of the C22, behind the front panel. These controls are conveniently accessible by releasing the PANLOC buttons and sliding the C22 out to the adjust position.

The power supply deserves special mention. The power transformer is constructed with "core" type grain oriented laminations and magnetic shielding for low external hum-fields. Long life rectifiers with full wave rectification, filter condenser sectionalizing and careful grounding add to the hum-free long life characteristics of the C22.

Special attention has been given to the mechanical design. The PANLOC system is the first professional installation technique to be used on stereo instruments. The PANLOC system gives you absolute ease of installation, operation and maintenance. The C22 may be conveniently installed in furniture cabinets, custom-built installations, professional relay racks or an attractive finished McIntosh cabinet.

MECHANICAL SPECIFICATIONS

Size:

Front panel; 16 inches wide by $5\frac{7}{16}$ inches high; chassis (including PANLOC shelf) 15 inches wide by 5 inches high by 13 inches deep, including connectors; clearance in front of mounting panel including knobs, $1\frac{1}{2}$ inches.

Weight:

16 pounds net, 25 pounds in shipping carton.

Finish:

Anodized gold and black (front panel).

ELECTRICAL SPECIFICATIONS

Power Requirement:

117 volts 50/60 cps AC, 34 watts.

Input Sensitivity and Impedance:

Auxiliary, Tape, Tuner 1, and Tuner 2: 0.25 volts, 250,000 ohms.

Phono 1 and Phono 2: 2 millivolts, 47,000 ohms.

Microphone: 2.5 millivolts, 1 megohm.

Tape Head: 2 millivolts, 1 megohm.

Tape Compare: 0.25 volts, 250,000 ohms.

Frequency Response:

± 0.5 db from 20 cps to 20,000 cps.

Distortion:

Less than 0.2% at 10 volts output.

Less than .02% at 3 volts output.

Total Noise:

High Level Inputs: 85 db below rated output.

Low Level Inputs: Less than 1.5 microvolts at input terminals.

Main Output:

2.5 volts with rated input.

Tape Output:

.25 volts with rated input.

Left Plus Right Output:

1 volt from generator impedance of 25,000 ohms.

Voltage Amplification:

Auxiliary, Tape, Tuner 1, and Tuner 2:

To Main Output, 20 db (10 to 1).

To Tape Output, 0 db (1 to 1).

Phono 1 and Phono 2 (At 1 KC):

To Main Output, 62 db (1250 to 1).

To Tape Output, 42 db (125 to 1).

Microphone:

To Main Output, 60 db (1000 to 1).

To Tape Output, 40 db (100 to 1).

Tape Head (At 500 cps):

To Main Output, 62 db (1250 to 1).

To Tape Output, 42 db (125 to 1).

A.C. Outlets:

1 unswitched (Red) for turntable or tape machine.

4 switched.

Tubes:

6 each 12AX7.

Tape Jack Switch:

2 position, connects panel jacks to allow signals to be fed from or to the C22 to record or playback using an external portable tape recorder.

Bass Controls:

Separate channel 11 position switch type, ± 20 db at 20 cycles.

Treble Controls:

Separate channel 11 position switch type, ± 20 db at 20,000 cycles.

Compensator Switch:

RIAA or LP record equalization.

Tape Switch:

Normal, or Tape Monitor.

Rumble Filter:

50 cps cutoff.

HF Filter:

5000 cycle cutoff.

Additional Set-Up Controls:

The following controls are located behind the front panel on the top of the C22 chassis.

These controls are readily accessible by depressing the PANLOC buttons to slide the C22 forward from the mounting panel:

Output Level Controls (L, L + R, and R):

Allows the balance of the entire system to be conveniently adjusted.

Low Frequency Trim Controls (L and R):

Allows frequencies below 100 cps to be boosted up to 6 db to compensate for unequal speaker response.

Tape Equalization Controls (L and R):

Adjusts tape head input high frequency response.

Phase Switch:

2 position, normal (0°) or reverse (180°).

Pilot Lamp Intensity Switch:

2 position, bright or dim.

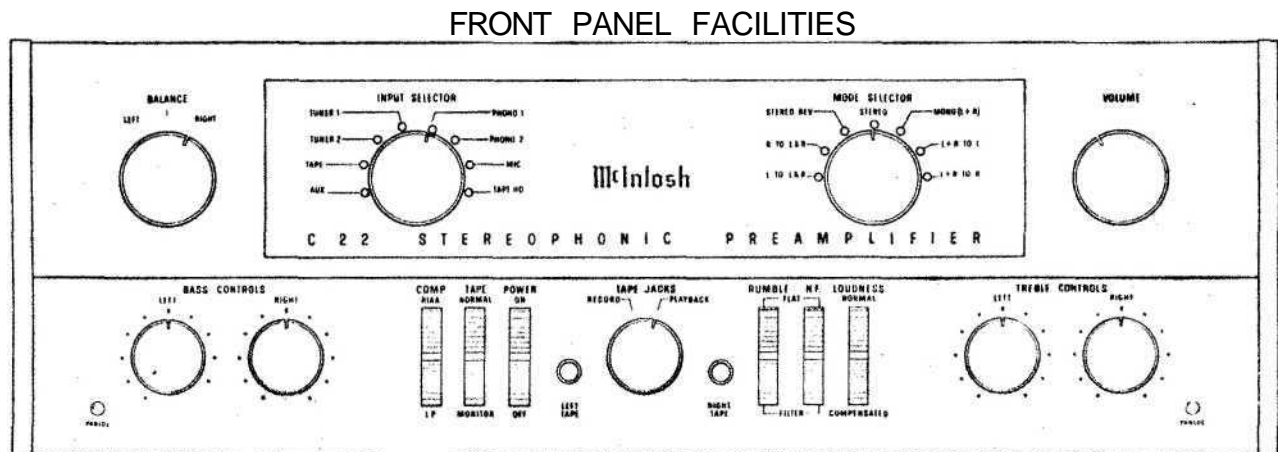

Figure 1. C22 Front Panel.

INPUT SELECTOR

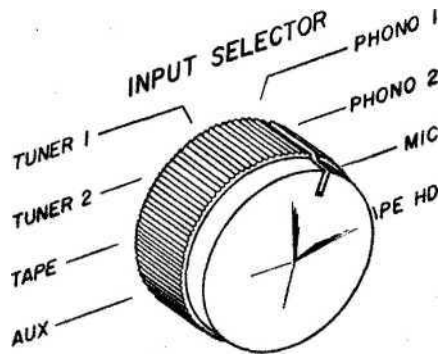

Figure 2. INPUT SELECTOR switch.

Select any one of eight program sources with this switch:

1. AUX: any auxiliary service requiring flat amplification, such as a television set, is connected to the C22 through the AUX position.
2. TAPE: any self-contained tape machine (tape machine having its own playback preamplifier) is connected to the C22 through the TAPE position.
3. TUNER 1: AM and FM or MPX FM outputs from a stereo tuner are connected to the C22 through the TUNER 1 position.
4. TUNER 2: same as TUNER 1.
5. PHONO 1: connects the C22 for stereo and monophonic operation for records.
6. PHONO 2: same as PHONO 1.
7. MIC: stereo microphones are connected to the C22 through the MIC position.
8. TAPE HD: a tape deck that does not contain its own playback preamplifier is connected to the C22 through the TAPE HD position.

MODE SELECTOR

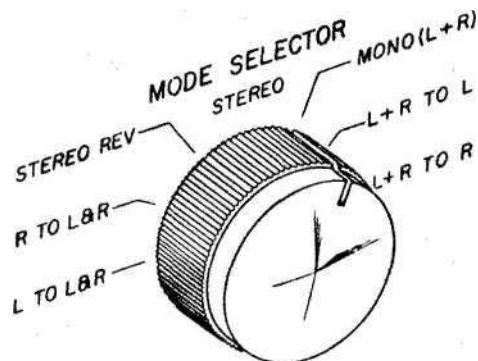

Figure 3. MODE SELECTOR switch.

Use the MODE SELECTOR to:

Listen to normal stereo (4 following and page 13).

Reverse the left and right arrangement of musical instruments (3 following and page 12).

Balance the amplifiers and loudspeakers in a stereo system (6 and 7 following and page 11).

Listen to monophonic sound (1 and 2 following and page 13).

Listen thru both loudspeakers to either track of a stereo program source (1 and 2 following and page 13).

Turn the MODE SELECTOR to:

1. L TO L & R: connects the "left" input to both loudspeakers.
2. R TO L & R: connects the "right" input to both loudspeakers.
3. STEREO REV: connects the "left" input to the "right" loudspeaker and the "right" input to the "left" loudspeaker.
4. STEREO: connects the "left" input to the "left" loudspeaker and the "right" input to the "right" loudspeaker.
5. MONO (L + R): adds the "left" input and the "right" input and then connects the L + R program to both amplifiers and loudspeakers.
6. L + R TO L: connects the "left plus right" programs to the "left" loudspeaker only.
7. L + R TO R: connects the "left plus right" programs to the "right" loudspeaker only.

VOLUME



Figure 4. VOLUME control.

Use the VOLUME control to regulate the combined volume level of both channels. Turning the VOLUME control clockwise increases volume level.

BALANCE CONTROL

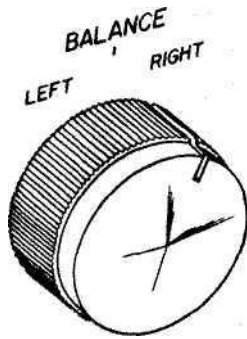

Figure 5. BALANCE CONTROL.

Use the C22 BALANCE control to balance unequal volume in the left and right channels of a program source. The volume of each speaker system relative to the other can be varied, at the same time their combined volume level is maintained.

LEFT . . . turning the control to the left accents the left channel by reducing the right channel output.

RIGHT . . . turning the control to the right accents the right channel by reducing the left channel output.

BASS CONTROLS

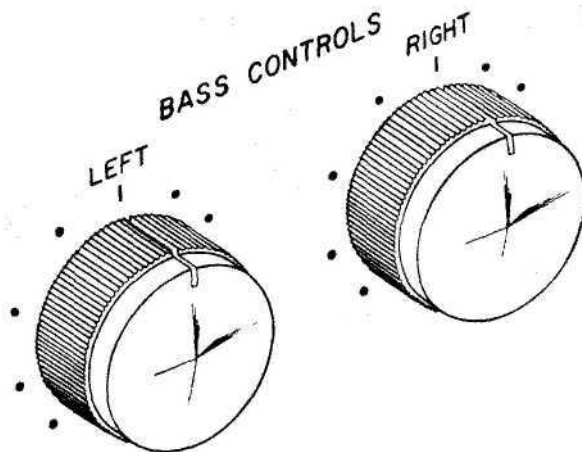

Figure 6. BASS CONTROLS.

Use the LEFT and RIGHT BASS CONTROLS to regulate bass loudness to the left and right speakers, respectively. Clockwise rotation increases bass loudness; counter-clockwise rotation decreases bass loudness. Each switch step of the BASS control changes bass loudness approximately 4 db.

TREBLE CONTROLS

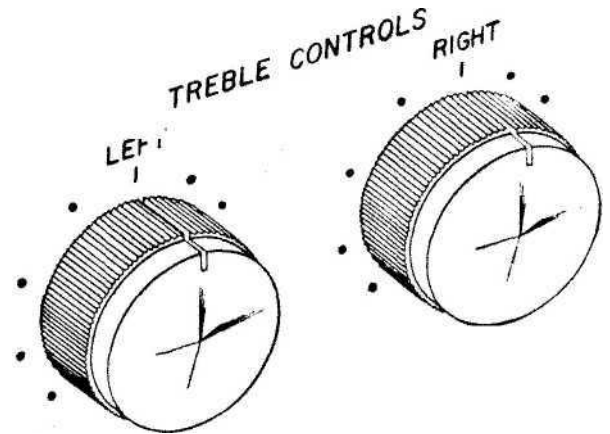

Figure 7. TREBLE CONTROLS.

Use the LEFT and RIGHT TREBLE CONTROLS to regulate treble loudness to the left and right speakers, respectively. Clockwise rotation increases treble loudness; counter-clockwise rotation decreases treble loudness. Each switch step of the TREBLE Control changes treble loudness approximately 4 db.

COMP (COMPENSATION)

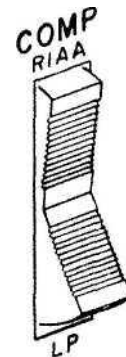

Figure 8. COMP (COMPENSATION) switch,

Use the COMP switch to correct for phono equalization introduced by the recording process. All current LP and Stereo recordings use RIAA equalization. Some stereo and early mono recordings use LP equalization.

TAPE JACKS

Use the C22 TAPE JACKS to hear a program originating from a portable tape machine or to record a program picked up by the C22 on a portable tape machine.

RECORD connects signals from the rear tape jacks to the INPUT SELECTOR TAPE position. Any program picked up by the C22 is connected to the portable machine

for recording.

PLAYBACK . . . TAPE input is switched from rear tape jacks to front panel telephone jacks (left tape and right tape). Any program originating from a portable machine connected to the C22 can be heard by rotating the INPUT SELECTOR to the TAPE position.

LEFT TAPE . . . telephone jack female receptacle for the left channel of a portable tape machine.

RIGHT TAPE . . . telephone jack female receptacle for the right channel of a portable tape machine.

TAPE

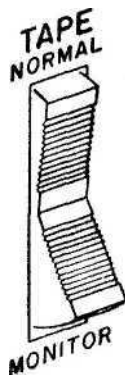

Figure 9. TAPE switch.

Use the C22 TAPE switch to know instantaneously, as you are recording, that the music on the tape is acceptable. The C22 TAPE switch makes it possible to instantaneously compare recorded material with the source signal. Tape jacks on the back panel accept a signal from a tape recorder with a monitor head and preamplifier.

NORMAL . . . the program source is fed through the power amplifiers and the loudspeakers.

MONITOR . . . the signal source becomes the monitored program from the recorded tape and is fed through the power amplifiers and loudspeakers.

POWER

The C22 and four black receptacles on the back panel are turned on and off by the POWER switch.

RUMBLE

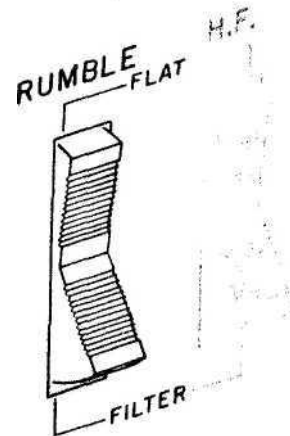

Figure 10. RUMBLE filter switch.

Use the C22 RUMBLE filter to reduce low-frequency noise created by a turntable or record changer and acoustically coupled feedback.

FLAT . . . filter disconnected.

FILTER . . . low-frequency rumble noise below 50 cps created by a turntable or record changer and acoustically coupled feedback are reduced when the RUMBLE filter button is pushed to the FILTER position.

H.F. (HIGH-FREQUENCY FILTER)

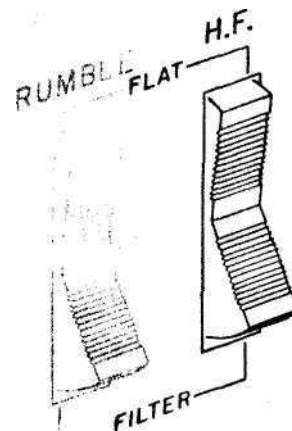

Figure 11. H.F. (High-Frequency Filter) switch.

This switch minimizes surface noise when reproducing old, badly worn recordings.

FLAT . . . filter disconnected.

FILTER . . . rolls off response sharply at 5 KC.

LOUDNESS

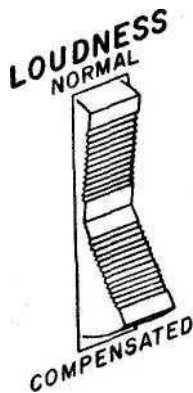

Figure 12. LOUDNESS switch.

Use the LOUDNESS switch in the COMPENSATED position to listen at low volume and still hear full-frequency range. When you turn down the volume, the music will seem to lose much of its bass and some of its treble. This effect is due to the sensitivity characteristics of human hearing. The response of the human ear to bass and treble pitch decreases more rapidly than its response to notes centered in the midtonal range. The LOUDNESS switch automatically provides the correct amount of bass and treble boost required to compensate for this change in response of the human ear at low-loudness levels. When the LOUDNESS switch is moved to the COMPENSATED position, it converts the volume control to a loudness compensated control.

CONTROLS BEHIND THE FRONT PANEL

Depressing the PANLOC buttons allows the C22 to slide forward to a point approximately 3 inches from the mounting panel. In

this position, additional controls on top of the C22 chassis are available; the PHASE switch, LOW FREQUENCY TRIM CONTROLS, OUTPUT LEVEL CONTROLS, TAPE EQUALIZATION CONTROLS, and the PILOT LAMP INTENSITY switch.

PILOT LAMP INTENSITY

Use the PILOT LAMP INTENSITY to switch the front panel pilot lamps to DIM or BRIGHT.

TAPE EQUALIZATION

Use the TAPE EQUALIZATION controls to compensate for 3% tape speed for individual tape head characteristics. These controls should be set to NAB for normal 7.5 inch tape speed machines. Turning the TAPE EQUALIZATION controls clockwise increases the treble response; turning them counter-clockwise decreases treble response.

OUTPUT LEVEL CONTROLS

Use the OUTPUT LEVEL controls to balance the overall amplifier-speaker system. The minimum setting on each control reduces the output level approximately 15 db. The L + R (left plus right) control adjusts only the output from the L + R output jack. This control can turn the L + R signal completely off.

LOW FREQUENCY TRIM CONTROLS

Use these controls to adjust for unequal speaker response at low frequencies due to room location of speakers. Approximately 6 db of boost below 100 cycles is available.

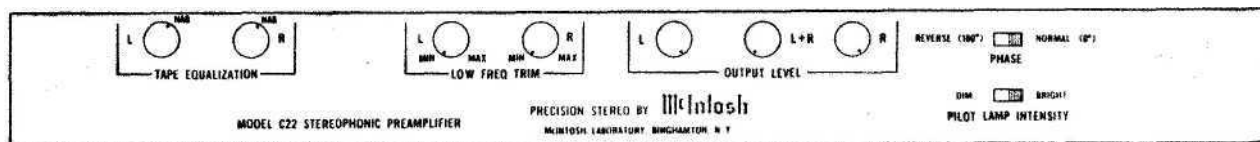

Figure 13. Controls Behind the Front Panel.

PANLOC BUTTONS

At the bottom front corners are the PANLOC buttons. After a preamplifier is installed on the PANLOC shelf, depressing the PANLOC buttons will lock the preamplifier firmly in position. Depressing the PANLOC buttons a second time (as with a ball-point pen) will release the preamplifier. The pre-

amplifier can then be slid forward to the inspection and adjustment position. Releasing the ADJUST position latches allows you to slide the preamplifier completely out of its mounting shelf, or back into normal operating position. The PANLOC system gives you absolute ease of installation, operation and maintenance.

INSTALLATION

The C22 can be installed in conventional furniture cabinets, custom built installations or professional relay racks. If the unit is to be placed on a shelf or table-top, it is recommended that it be housed in a McIntosh cabinet. The C22 installs conveniently from the front of the cabinet by sliding into its PANLOC shelf.

To support the weight of the C22, the

wood panel used to mount it should be at least $\frac{1}{4}$ inch thick.

The C22 installation should allow approximately 14 inches behind the front panel to mount the PANLOC shelf and allow for connecting wires. To allow sufficient space for the circulating air, the desirable minimum internal cabinet dimensions should be 16 inches and $5\frac{1}{2}$ inches respectively.

CONNECTING

AC CONNECTIONS

There are five AC outlets on the rear panel of the C22 (See Figure 14.) These receptacles have a maximum rating of 660 watts total. The power to the four black receptacles is controlled by the POWER switch on the front panel. The red receptacle is not switched. The red receptacle is used for powering a turntable or record changer. The receptacle

is not switched so that the turntable power will not be turned off while the turntable idler wheel is engaged. The turntable is protected by this arrangement because it is necessary to turn off the turntable with its own control switch so that no damage will result to the turntable drive system.

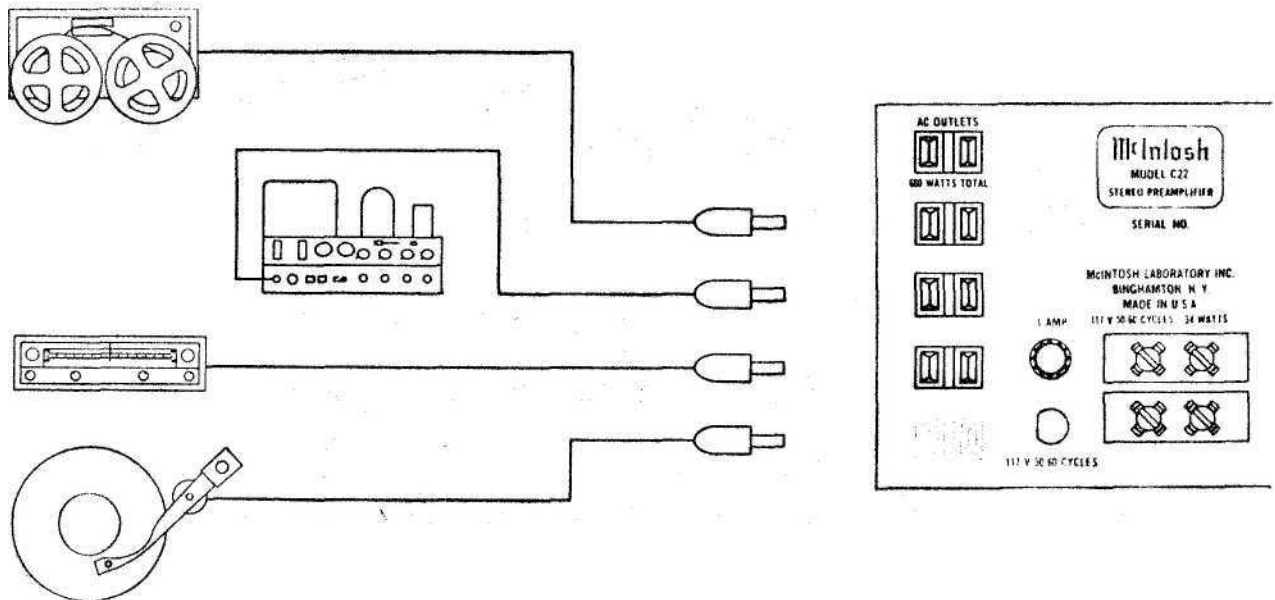

Figure 14. A-C Connections.

AC POWER

Plug the AC power cord in 105 volt to 125 volt, 50 to 60 cycle power line. The power used by the C22 is 34 watts.

INPUT CONNECTIONS

The C22 provides eight separate program

inputs controlled by the INPUT SELECTOR switch. One input for tape monitor or tape comparison is controlled by the TAPE switch.

The input program connections should be made in accordance with Table 1.

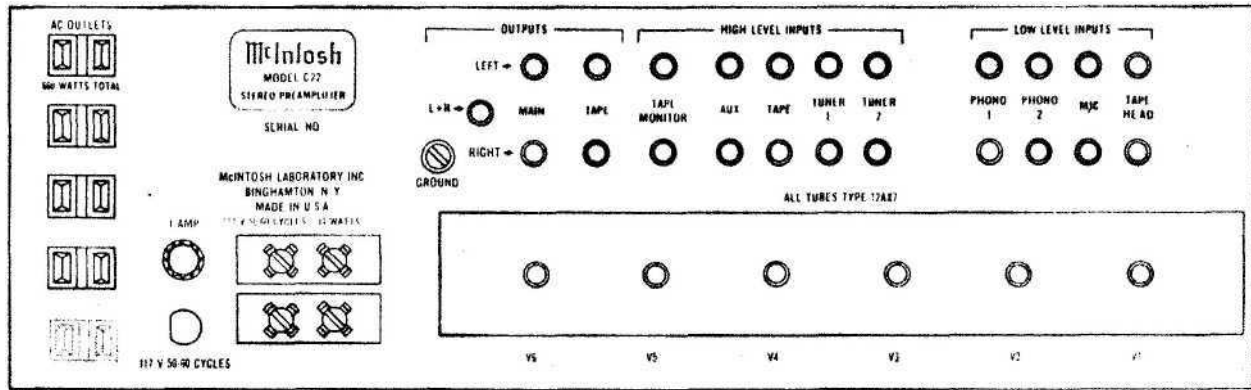

Figure 15. INPUT CONNECTIONS.

CONNECTION	FUNCTION	INPUT SENSITIVITY	INPUT IMPEDANCE
TAPE MONITOR (COMPARE)	The tape monitor input accepts a signal from a tape recorder with a monitor head and preamplifier.....	0.25V	250K
AUX	The auxiliary input accepts any auxiliary service requiring flat frequency response, such as a T.V. set, tuner, tape recorder with its own playback preamplifier, etc.	0.25V	250K
TAPE	The tape input operates with tape machines containing their own playback preamplifier.....	0.25V	250K
TUNER 1 & TUNER 2	The tuner inputs accept AM and FM outputs from a stereo tuner or a pair of stereo tuners or the multiplex output of an adapter of multiplex tuner.....	0.25V	250K

CONNECTION	FUNCTION	INPUT SENSITIVITY	INPUT IMPEDANCE
PHONO 1 & 2 MAGNETIC	These jacks are to be used with magnetic cartridges...	2MV	47K
TAPE HEAD 1 & 2 2-10MV	These jacks are to be used with a tape deck that does not contain its own playback preamplifier.....	2MV	1 megohm
MIC	These jacks are to be used with high impedance crystal or dynamic microphones.....	2.5 MV	1 megohm

If a phono cartridge requires less than 47,000 ohms load impedance, a resistor can be added across the terminals of the car-

tridge to achieve the correct termination. The following chart may be used as a guide:

Desired Impedance
 47,000 ohms (47K)
 37,000 ohms (37K)
 27,000 ohms (27K)
 15,000 ohms (15K)
 6,800 ohms (6.8K)

Resistor Across Input
 No Resistor
 180,000 ohms (180K)
 62,000 ohms (62K)
 22,000 ohms (22K)
 8,200 ohms (8.2K)

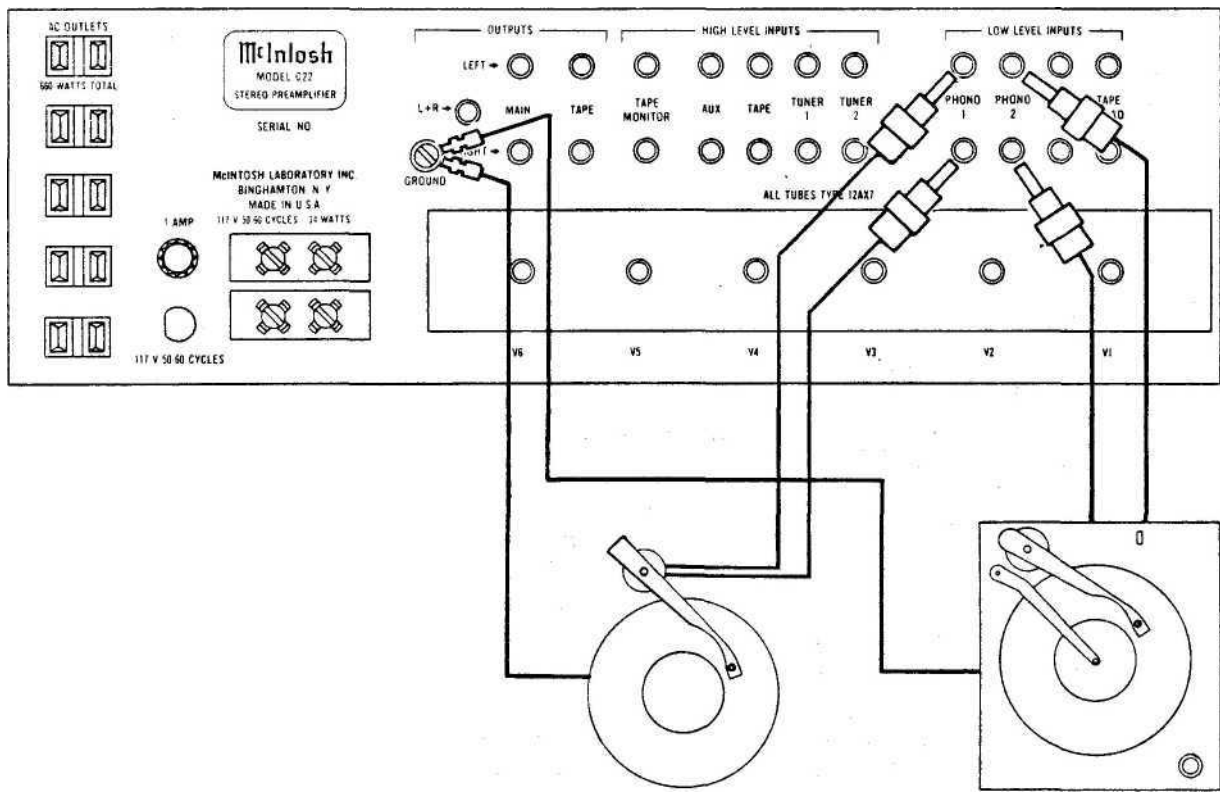

Figure 16. Turntables feeding low-level inputs.

OUTPUT CONNECTIONS

There are two sets of outputs on the left half of the back panel. (See Figure 15) One pair is marked MAIN. The second pair is marked TAPE.

The MAIN outputs connect to power amplifiers (figure 17). The TAPE output feeds a tape recorder.

The MAIN jacks are fed from cathode followers. Longer cables than are normally supplied can be connected between the C22 and the amplifiers. The length of the cable is limited by the capacity of the cable. The total capacity must not exceed 1000 mmf. For

instance: cables with a capacity of 25 mmf per foot may be 40 feet long; 13.5 mmf per foot cable may be 75 feet long. The input impedance of the amplifiers should be 50,000 ohms or greater.

The TAPE output is fed from a cathode follower. The program material fed out of the TAPE output is not affected by these front panel controls: VOLUME control, BASS controls, LF and HF filter switches, BALANCE control, LOUD switch, TAPE switch, PHASE switch, TREBLE controls, and MODE SELECTOR switch.

The program material fed out of the TAPE output is affected by these front panel con-

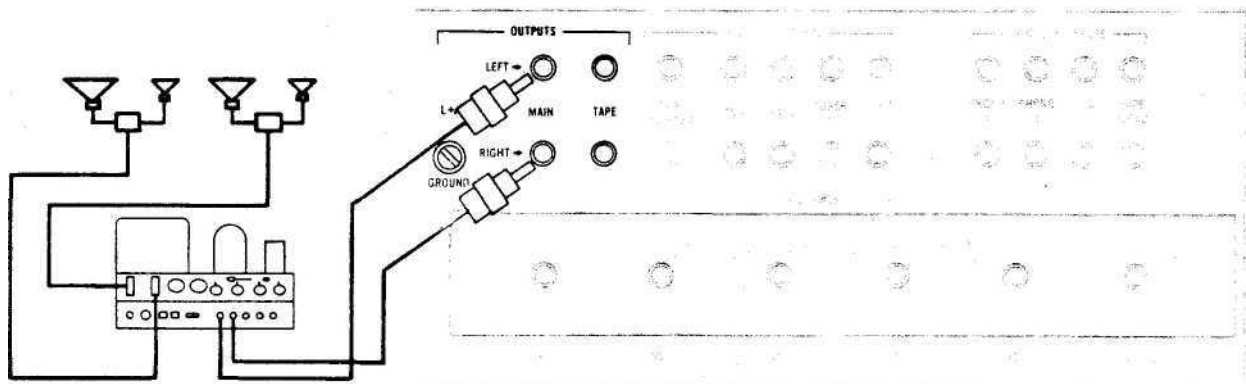

Figure 17. MAIN OUTPUT Connected to Power Amplifiers.

trols: INPUT SELECTOR positions, AUX, TAPE, TUNER 1, TUNER 2, or MIC, the MUTING switch and TUNING control. When the INPUT SELECTOR is turned to TAPE HD then the COMP should be set to RIAA.

The input impedance of the tape recorder should be 50,000 ohms or greater.

A jack marked L + R OUTPUT is located next to MAIN OUTPUTS.

A monophonic signal can be distributed to other rooms by connecting another power amplifier to the jack marked L + R. The cable connecting this output to the amplifier should not have a capacity of more than 1000 mmf. The input impedance of the power amplifier connecting to this output should not be less than 150,000 ohms (150K).

LOUDSPEAKER PHASING CONNECTIONS

Two pairs of screw terminals are located on the lower left section of the C22 back panel. The speaker leads from the "left" power amplifier should be connected to the screw terminals marked FROM AMPLIFIER.

The pair of terminals marked TO SPEAKER should be connected to the "left" loudspeaker.

These connections allow the front panel PHASE switch to reverse the phase on the left loudspeaker. This arrangement is convenient when setting up a stereo system.

GROUND CONNECTION

A single ground post is provided. The chassis ground from turntable, record changers (motors used with each), tape decks, etc., should be returned to this post. Do not duplicate this ground circuit. Hum is likely to be heard in the system if duplicate ground returns are used.

The left and right program cables from each source should be twisted together and the ground wire from each source can be wound or twisted in with these cables. To avoid hum, make sure the ground wire does not make any connections to shields of the left and right channel cables except for the connection provided with the C22 ground post.

OPERATING INSTRUCTIONS

BALANCING A STEREO SYSTEM

The performance and enjoyment of a stereo system is greatly increased when the system is properly balanced. There are two factors that require balancing. One is the unequal program loudness on the left and right channels of a program source. The control marked BALANCE on the C22 is used to balance unequal program loudness. Balancing a program for unequal loudness is explained under ADJUSTING BALANCE CONTROL TO CORRECT PROGRAM MATERIAL.

The other factor that requires balancing is system balance. The balance of the stereo system is affected by many things including room acoustics, furniture placement, room shape, small differences in loudspeakers, etc. Balancing the system is done by adjusting the controls on the power amplifiers.

To begin balancing the system, check to see that the controls on the amplifier are properly set. If the amplifier is a McIntosh MC225, set the input switch to STEREO. Turn both input level controls to the black dot at the 12 o'clock position of the control.

If the amplifier is a McIntosh MC240 or MC275 check to see that the cables from the C22 are plugged into the STEREO INPUT jacks. Then set the lever switch to STEREO. Turn the BALANCE control to the 0 mark at the 12 o'clock position of the control. The amplifiers are now ready for the rest of the steps to balancing the system.

1. Play a familiar recording on the record player.
2. Push the two PANLOC buttons to release the C22 from the mounting shelf. Pull the C22 toward you until the latch locks engage approximately 3 inches from the front panel.
3. Turn the INPUT SELECTOR to the PHONO position into which the record player is connected.
4. Turn the BASS CONTROLS and TREBLE CONTROLS so that the knob indicators are centered between the panel markings L and R.
5. Turn the BALANCE control to the center or 12 o'clock position.
6. Place the LOUDNESS switch in the

COMPENSATED position.

7. Place the TAPE switch in the MONITOR position.
8. Place the PHASE switch in the 0° position.
9. Place the RUMBLE filter switch in the FLAT position.
10. Place the H.F. cutoff filter switch in the FLAT position.
11. Turn the MODE SELECTOR to the L + R TO L position.
12. While the program is playing, alternate the MODE SELECTOR between the L + R TO R and the L + R TO L position. On amplifiers such as the MC225, adjust the correct gain control until the loudspeakers are of equal loudness. On the MC240 or the MC275, turn the balance control until the loudspeakers are of equal loudness.

The stereo system is now balanced. It will remain balanced through all modes of operation. Leave the C22 extended on its PANLOC stops for the next series of adjustments.

ADJUSTING PHASE

1. Set the MODE SELECTOR to STEREO.
2. Turn the BASS controls and TREBLE controls to straight up position so that the dial indicator centers between the panel markings L and R.

Stand approximately 10 feet in front of and midway between the loudspeakers. The source of sound should appear to be directly in front of you. Alternate the PHASE switch between 0° and 180°. If the sound is not directly in front of you in the 0° position, reverse the leads to one loudspeaker. The PHASE control is used to correct phase in the source material whenever necessary.

ADJUSTING BALANCE CONTROL AFTER THE SYSTEM HAS BEEN BALANCED

When these instructions have been completed, the overall system is balanced and in phase; ready to deliver maximum pleasure and enjoyment.

You may hear differences in balance from one record to another or from one tape to another. Some records or tapes may be recorded with slight differences between channels. The differences can be corrected with the BALANCE control on the front panel. If the difference is heard on every record, then the cartridge may have a very small difference in output.

ADJUSTING FOR SPECIAL EFFECTS

HF CUTOFF FILTER

If you wish to reproduce old, badly worn records, you can minimize the surface noise by switching the HF cutoff filter to the IN position.

RUMBLE FILTER

If you are using a turntable or changer which has low-frequency rumble noise, you may reduce it by pushing the RUMBLE filter switch to the FILTER position.

BASS CONTROLS AND TREBLE CONTROLS

The tone balance which you hear when listening to an orchestra is affected by the conductor's instructions to his musicians, the acoustical environment in which you are listening, and your own subjective hearing interpretation. Considering these conditions, it is easy to see why tone balance controls play a major role in correcting for the following factors:

1. Each person's subjective idea of tone balance.
2. Loudspeaker frequency response characteristics.
3. Loudspeaker placement in the listening room.
4. The conductor's idea of tone balance at the time the recording was made.
5. The microphone frequency response characteristics.
6. The recording process influences.

These factors can be considered as environmental influences. The BASS CONTROLS and TREBLE CONTROLS provide a degree of compensation for effects of environment. Listen to your system with each control set with the indicators centered between the panel markings L and R. If you wish to reduce treble in relation to bass for example, turn the TREBLE CONTROLS counterclockwise until the tone balance sounds correct to you. These controls will modify tone balance without introducing any undesirable effects. Do not be surprised if you find your preference in tone changing from time to time.

LOUDNESS

Due to a selective shift in sensitivity of human hearing, music reproduced at very low volume loses its bass and treble.

The LOUDNESS switch on the C22 changes the VOLUME control to a loudness compensated control to correct for this effect. When you wish to listen to music at a greatly reduced loudness level and yet hear bass and treble in their proper relationships, set the LOUDNESS switch to the IN position.

PHASE

If the stereo sound seems to come from either side of the room instead of being distributed between the loudspeakers, adjust the PHASE control to 180°. This listening effect is due to reproducing sound that is out of phase from one channel to the other. You will find some records differ from others in this respect and that some tapes differ from records.

LISTENING TO A STEREO TUNER

1. Turn the INPUT SELECTOR to TUNER 1 or TUNER 2.
2. Turn the MODE SELECTOR to STEREO.
3. Set the PHASE switch to 0°.
4. Set the H.F. cutoff filter switch to FLAT. (See page 12 ADJUSTING FOR SPECIAL EFFECTS.)
5. Set the RUMBLE filter switch to FLAT. (See page 12 ADJUSTING FOR SPECIAL EFFECTS.)
6. Set the LOUDNESS switch to NORMAL. (See page 12 ADJUSTING FOR SPECIAL EFFECTS.)
7. Turn the BASS CONTROLS and TREBLE CONTROLS so that the indicators are centered between the panel markings L and R. (See page 12 BASS AND TREBLE CONTROLS.)
8. Set the TAPE switch to NORMAL.
9. Adjust the VOLUME control to the desired volume.

After a warm up of about 30 seconds, turn the tuning knob on your tuner to find the station of your choice.

LISTENING TO A STEREO RECORD

To listen to stereo records, proceed as follows:

1. Turn the INPUT SELECTOR to PHONO 1 or PHONO 2, whichever is connected to the cartridge you wish to hear.
2. Set the MODE SELECTOR to STEREO.
3. Set the PHASE switch to 0°.
4. Set the HF cutoff filter to FLAT. (See page 12 ADJUSTING FOR SPECIAL EFFECTS.)
5. Set the RUMBLE filter control to FLAT.

(See page 12 ADJUSTING FOR SPECIAL EFFECTS.)

6. Set the LOUDNESS control to NORMAL. (See page 12 ADJUSTING FOR SPECIAL EFFECTS.)
7. Set the TAPE switch to NORMAL.
8. Set the BASS CONTROLS and TREBLE CONTROLS so that the indicators are centered between the panel markings L and R. (See page 12 BASS AND TREBLE CONTROLS.)
9. Adjust the VOLUME control to the desired volume.

LISTENING TO MONOPHONIC RECORDS

To listen to monophonic records, proceed as follows:

1. Turn the INPUT SELECTOR to PHONO 1 or PHONO 2, whichever is connected to the cartridge you wish to hear.
2. Turn the MODE SELECTOR to MONO (L+R).
3. Set the PHASE switch to 0°.
4. Set the HF cutoff filter to FLAT. (See page 12 ADJUSTING FOR SPECIAL EFFECTS.)
5. Set the RUMBLE filter control to FLAT. (See page 12 ADJUSTING FOR SPECIAL EFFECTS.)
6. Set the LOUDNESS control to FLAT. (See page 12 ADJUSTING FOR SPECIAL EFFECTS.)
7. Set the BASS CONTROLS and TREBLE CONTROLS so that the indicators are centered between the panel markings L and R. (See page 12 BASS AND TREBLE CONTROLS.)
8. Adjust the VOLUME control to the desired volume.

LISTENING TO TAPE DECKS

To listen to tape from a tape deck, proceed as follows:

1. Turn the INPUT SELECTOR to TAPE HEAD.
2. Turn the MODE SELECTOR to MONO (L + R) or STEREO, depending on the program on the tape.
3. Set the PHASE switch to 0°.
4. Set the HF cutoff filter to FLAT. (See page 12 ADJUSTING FOR SPECIAL EFFECTS.)
5. Set the RUMBLE filter control to FLAT. (See page 12 ADJUSTING FOR SPECIAL EFFECTS.)
6. Set the LOUDNESS control to FLAT. (See page 12 ADJUSTING FOR SPECIAL EFFECTS.)
7. Set the BASS CONTROLS and TREBLE

CONTROLS so that the dial indicators are centered between the panel markings L and R.

8. Adjust the VOLUME control to the desired volume.

LISTENING TO A STEREO TAPE MACHINE

A stereo tape machine with its own playback preamplifiers should be plugged into the AUX input or the TAPE MONITOR input—not the TAPE HEAD input.

If the TAPE input is used, proceed as follows:

1. Turn the INPUT SELECTOR to TAPE.
2. Turn the MODE SELECTOR to MONO (L + R) or STEREO depending on the program on the tape.
3. Set the PHASE switch to 0°.
4. Set the HF cutoff filter to FLAT. (See ADJUSTING FOR SPECIAL EFFECTS.)
5. Set the RUMBLE filter control to FLAT. (See page 12 ADJUSTING FOR SPECIAL EFFECTS.)
6. Set the LOUDNESS control to NORMAL. (See page 12 ADJUSTING FOR SPECIAL EFFECTS.)
7. Set the BASS CONTROLS and TREBLE

USING THE C22 FRONT PANEL TAPE INPUT JACKS

Two tape machines can be used with the C22 Stereophonic Preamplifier. After you have connected your tape machine to the rear panel of the preamplifier someone may desire to bring in a portable machine to make a copy of one of your tapes or to listen to one of his tapes on your system. With the C22 you no longer have to unplug your permanent machine. The C22 is supplied with two cables. The cables have phone plugs on one end to plug into the front panel of the C22 and pin jacks on the other end to plug into any tape machine. (Adapters are available at any Hi-Fi retailer to permit pin plugs to connect with phone jacks.)

To listen to the portable or second tape machine plug the pin jack end of the two C22 cables, mentioned above, into the tape machine output. Connect the telephone plugs into the telephone jacks on the C22 front panel. The left jack supplies the left channel. The right jack supplies the right channel. Turn the INPUT SELECTOR switch to TAPE. When the TAPE JACK control is turned to the PLAYBACK position, the permanent tape machine output is discon-

CONTROLS so that the dial indicators are centered between the panel markings L and R.

8. Adjust the VOLUME control to the desired volume.

If the AUX input is used, turn the INPUT SELECTOR to AUX; then, proceed the same as for TAPE input.

1. Set the TAPE MONITOR switch to MONITOR.
2. Turn the MODE SELECTOR switch to MONO (L + R).
3. Set the PHASE switch to 0°.
4. Set the HF cutoff filter to FLAT. (See page 12 ADJUSTING FOR SPECIAL EFFECTS.)
5. Set the RUMBLE filter control to FLAT. (See page 12 ADJUSTING FOR SPECIAL EFFECTS.)
6. Set the LOUDNESS control to FLAT. (See page 12 ADJUSTING FOR SPECIAL EFFECTS.)
7. Set the BASS CONTROLS and TREBLE CONTROLS so that the dial indicators are centered between the panel markings L and R.
8. Adjust the VOLUME control to the desired volume.

nected from the rear panel. The portable tape machine is now connected and any program originating in this machine will be heard through the C22, and will also be available from the C22 TAPE OUTPUT to drive the permanent tape machine input. This feature allows you to copy a tape from the portable machine into your permanent machine, provided your permanent machine has its own recording preamplifier.

To record on the portable machine plug the two phono pin plugs of the two C22 cables into the input of the portable machine. Leave the telephone plugs connected to the C22 telephone jacks on the front panel. Operate the TAPE JACK switch to the RECORD position. The permanent tape machine will be reconnected. Now any program picked up by the INPUT SELECTOR switch will be available to drive the portable machine. You can now make a copy on the portable machine of any tape played on the permanent machine. You can copy any other program source onto both tape machines at the same time.

When recording from one tape machine to

the other the only control that is effective is the TAPE JACK switch. (Note: Some portable tape machines will drive the C22 even though the TAPE JACK switch is in the RECORD

USING THE C22 WITH MICROPHONES FOR STEREO

Microphones in stereo may be used with the C22. The two MIC channels amplify microphone signals. They have a sensitivity of 2 millivolts and an input impedance of 1 megohm. For lower output microphones input transformers should be used to raise the

position.) This is not a normal circuit use and a distorted signal usually results. For low-distortion operation follow the recommended procedure.

voltage output to the 2 millivolt range.

When the INPUT SELECTOR is turned to the MIC position, the COMP control does not operate. All the other controls operate and may be used the same as for any other program source.

OPERATING CURVES

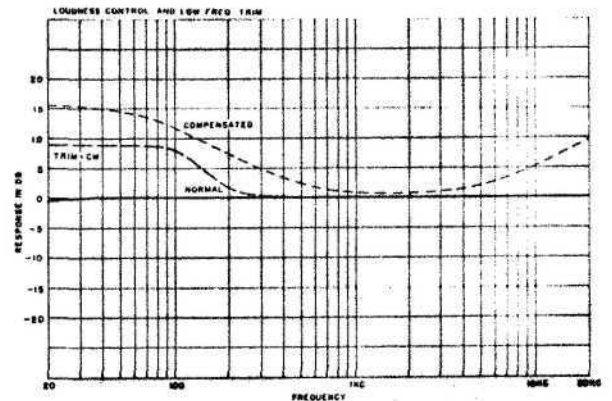
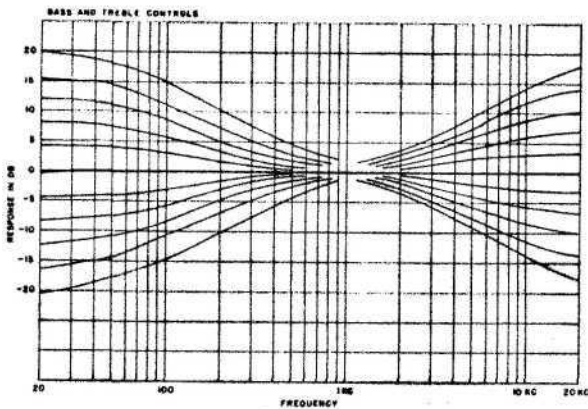
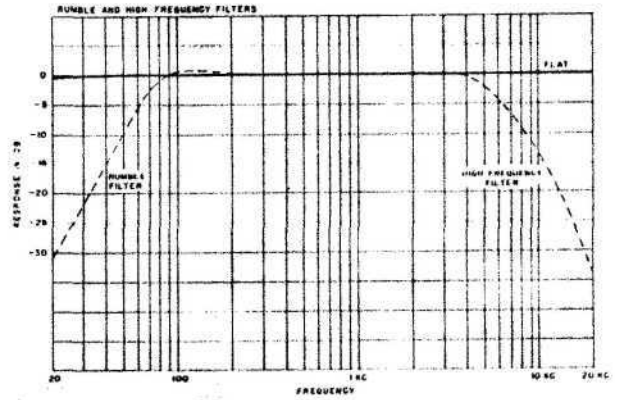
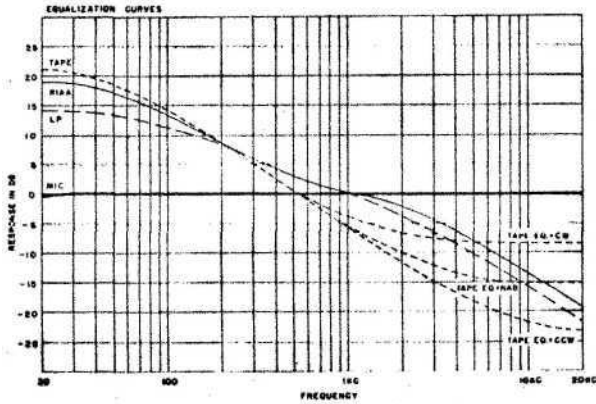

Your C22 will give you many years of pleasant and satisfactory performance. If you have any questions concerning the operation or maintenance of this preamplifier please contact:

Customer Service
McIntosh Laboratory Inc.
2 Chambers Street
Binghamton, New York
Our telephone number is 723-5491.
The direct dial area code is 607.

GUARANTEE

McIntosh Laboratory Incorporated guarantees this equipment to perform as advertised. We also guarantee the mechanical and electrical workmanship and components of this equipment to be free of defects for a

period of 90 days from date of purchase. This guarantee does not extend to components damaged by improper use nor does it extend to transportation to and from the factory.

3-YEAR FACTORY SERVICE CONTRACT

An application for a FREE 3-YEAR FACTORY SERVICE CONTRACT is included in the pocket in the back cover of this manual. The FREE 3-YEAR FACTORY SERVICE CONTRACT will be issued by McIntosh Laboratory upon receipt of the completely filled out application form. The term of this contract is de-

finied in the 3-year factory service contract. If the application is not mailed to McIntosh Laboratory, only the services offered under the standard 90-day guarantee will apply on this equipment. TAKE ADVANTAGE OF 3 YEARS OF FREE FACTORY SERVICE BY FILLING IN THE APPLICATION NOW.

In Canada: manufactured under license by:
McCurdy Radio Industries, Ltd.
22 Front Street West
Toronto, Canada

Design subject to change without notice.

McIntosh
LABORATORY INC.

2 CHAMBERS STREET, BINGHAMTON, N.Y.

Made in U.S.A.

Phone—Area Code 407-723-3512
Be122002