

Owner's Manual

N°360S
Digital
Processor

mark
levinson®
Madrigal Audio Laboratories

WARNING: TO REDUCE THE RISK OF FIRE OR ELECTRIC SHOCK, DO NOT EXPOSE THIS APPLIANCE TO RAIN OR MOISTURE.

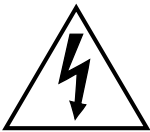
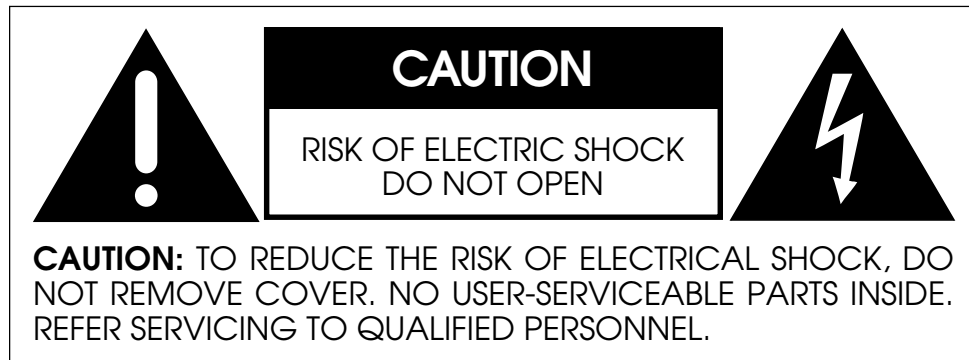

The lightning flash with arrowhead symbol, within an equilateral triangle, is intended to alert the user to the presence of uninsulated “dangerous voltage” within the product’s enclosure that may be of sufficient magnitude to constitute a risk of electric shock to persons.



The exclamation point within an equilateral triangle is intended to alert the user to the presence of important operating and maintenance (servicing) instructions in the literature accompanying the appliance.



Marking by the “CE” symbol (shown left) indicates compliance of this device with the EMC (Electromagnetic Compatibility) and LVD (Low Voltage Directive) standards of the European Community.

NOTICE

This equipment has been tested and found to comply with the limits for a Class B digital device, pursuant to Part 15 of the FCC Rules. These limits are designed to provide reasonable protection against harmful interference in a residential installation. This equipment generates, uses and can radiate radio frequency energy and, if not installed and used in accordance with the instructions, may cause harmful interference to radio communications. However, there is no guarantee that interference will not occur in a particular installation. If this equipment does cause interference to radio or television reception, which can be determined by turning the equipment on and off, the user is encouraged to try to correct the interference by one or more of the following measures:

- Reorient or relocate the receiving antenna;
- Increase the separation between the equipment and the receiver;
- Connect the equipment into an outlet on a circuit different from that to which the receiver is connected;
- Consult the dealer or an experienced radio/TV technician for help.

CAUTION: Changes or modifications to this equipment not expressly approved by the manufacturer could void the user’s authority to operate the equipment.

HD CD[®] and High Definition Compatible Digital[®] are registered trademarks of Pacific Microsonics, Inc.

The information contained in the manual is subject to change without notice. The most current version of this manual will be posted on our web site at <http://www.madrigal.com>.

Important Safety Instructions

Please read all instructions and precautions carefully and completely before operating your Mark Levinson component.

1. **ALWAYS** disconnect your entire system from the AC mains before connecting or disconnecting any cables, or when cleaning any component.
2. This product is equipped with a three-conductor AC mains power cord which includes an earth ground connection. To prevent shock hazard, all three connections must **ALWAYS** be used. If your electrical outlets will not accept this type of plug, an adapter may be purchased. If an adapter is necessary, be sure it is an approved type and is used properly, supplying an earth ground. If you are not sure of the integrity of your home electrical system, contact a licensed electrician for assistance.
3. AC extension cords are not recommended for use with this product. If an extension cord must be used, be sure it is an approved type and has sufficient current-carrying capacity to power this product.
4. **NEVER** use flammable or combustible chemicals for cleaning audio components.
5. **NEVER** operate this product with any covers removed.
6. **NEVER** wet the inside of this product with any liquid.
7. **NEVER** pour or spill liquids directly onto this unit.
8. **NEVER** block air flow through ventilation slots or heatsinks.
9. **NEVER** bypass any fuse.
10. **NEVER** replace any fuse with a value or type other than those specified.
11. **NEVER** attempt to repair this product. If a problem occurs, contact your Mark Levinson® retailer.
12. **NEVER** expose this product to extremely high or low temperatures.
13. **NEVER** operate this product in an explosive atmosphere.
14. **ALWAYS** keep electrical equipment out of the reach of children.
15. **ALWAYS** unplug sensitive electronic equipment during lightning storms.

From all of us at Madrigal Audio Laboratories, thank you for choosing the Mark Levinson N°360S Digital Audio Processor.

A great deal of effort went into the design and construction of this precision device. Used properly, it will give you many years of enjoyment.

Table of Contents

Unpacking and Placement	6
Send in Your Warranty Card!	6
Unpacking the N°360S	6
Placement of the N°360S	6
Operating Voltage	7
A Quick Start	8
Warm up & break-in period	9
Special Design Features	10
"24/96" capability & HDCD®	10
Guarding against obsolescence	10
An "intelligent" FIFO	11
Superior isolation between sources	12
HDCD® Gain-Matching	13
Front panel, N°360S	15
<i>toggle HDCD gain adjustment</i>	17
Display, N°360S	20
Rear panel, N°360S	22
<i>IR input tip polarity</i>	24
<i>Linking connections</i>	25
<i>Building link cables</i>	25
<i>Male XLR output connector (digital)</i>	26
<i>AC power cord polarity</i>	27
Setup and Installation	28
N°360S Input Names	28
Making Digital Connections	29
Making Analog Connections	30
Making Link Connections	30
Making PHASTLink Connections	30
<i>Building PHAST cables</i>	31
Input Names	31
Naming Your Inputs	32
Remote Control of the N°360S	34
Teaching N°360S Front Panel Commands	34
Teaching Other N°360S Commands	35
<i>special commands table</i>	36
Linked functions	37
Standby link	37
Name link	37
Play link	37
Display link	38
Polarity link	38
Troubleshooting	39
Care and maintenance	41
U.S. and Canadian Warranty	42
90-Day Limited Warranty	42
Five Year Extended Warranty	42
Obtaining Service	43
Specifications	44
Dimensions	45

Unpacking and Placement

Send in Your Warranty Card!

So far, you have only half a product. The other half is the ongoing service and support we can provide you to complement your new component and help you maximize your enjoyment of it. Unfortunately, we cannot give you this other half of the product you just purchased unless you tell us where to find you.

Sending in your warranty card will automatically add your name to our mailing list, and will allow us to contact you for the occasional special offer. We do not share this list with anyone; all names are held in strict confidence. We simply want the opportunity to provide superior service, as our way of thanking you for buying one of our products.

Unpacking the N°360S

Unpack your N°360S Digital Audio Processor and remove all accessories from the carton. Keep all packing materials for future transport.

Included with your new Mark Levinson processor is a pair of knit, white gloves designed to assist you in the initial unpacking and placement of your new purchase. Please accept them as a token of our appreciation for having purchased one of our products.

Placement of the N°360S

The N°360S should be placed close to your digital source equipment, keeping interconnect cabling short. We recommend shelf mounting to allow for proper ventilation. The N°360S is designed for continuous operation, which is why it features a **standby** mode rather than a full “off” mode—it is designed to be connected to the AC mains at all times for the best performance.

Please allow 3 to 4 inches of clearance above the N°360S to allow heat dissipation through air circulation.

Drawings are included in this manual to facilitate special installations and custom cabinetry (see “Dimensions”).

Operating Voltage

The N°360S Digital Audio Processor is set at the factory (internally) for 100V, 120V, 220V, 230V or 240V AC mains operation @ 50 or 60Hz. (230V/50Hz only in European Union countries, in compliance with CE regulations.) This voltage setting cannot be changed by the user. Make sure that the label on the bottom panel of the N°360S (adjacent to the AC cord) indicates the correct AC operating voltage for your location.

If the voltage indicated on your N°360S is incorrect, or if you wish to change the AC operating voltage of your N°360S as the result of moving to a different country than the one in which you purchased your digital audio processor, see your Mark Levinson dealer.

The N°360S can be powered by a normal 15-ampere AC mains line. If other devices are also powered from the same AC line, their additional power consumption should be taken into account.

For optimal sonic performance and longevity, the N°360S is designed to remain powered at all times (the **standby** switch merely mutes the processor's outputs and turns off the display). There is an initial break-in period of approximately 300 hours before the N°360S achieves optimum performance.

A Quick Start...

We recognize that many people are understandably eager to begin listening to their new components, and that reading the manual is often done (if at all) at a later time—perhaps while listening to music through the new product itself. We *strongly* recommend that you read this manual thoroughly, as the N°360S Digital Audio Processor incorporates several unusual features which enhance its operation.

Fortunately, we can help you get some music up and running on your system quickly, so that you may begin enjoying your new digital processor while reading more about it. The goal here is simply to make some music as quickly as possible. The following procedure assumes that the rest of your system is already connected (e.g., preamplifier to power amplifier, to speakers, etc.).

1 Turn off your associated components

This minimizes the opportunity for a momentary electrical surge disturbing your system while making connections. If you have a large power amplifier, allow its power supply to fully discharge before proceeding (which may take as long as several minutes, depending on its design).

2 Connect the AC cord to the N°360S and to your AC outlet

The AC receptacle for the power cord is located underneath the N°360S, in the center of the unit. (This design reduces noise by bringing the power into the chassis precisely where it is needed, rather than routing it throughout the unit.) The N°360S will take a few moments to initialize and will then be ready to use.

3 Connect a digital source to input 1 or 5

Inputs 1 and 5 on the N°360S are configured from the factory for CD transports, the most common type of digital transport. Input 1 is an aes/ebu (XLR-type) digital input; Input 5 is an S/PDIF (RCA-type) digital input. These digital inputs are found on the rear of the N°360S. Use high quality digital cable such as Madrigal MDC-1 for XLR-type, or MDC-2 for RCA-type connections. (All other inputs are configured as “not used” and will need to be named before they can be used. Naming of inputs is covered in this manual.)

4 Connect a set of analog outputs to your preamplifier

The N°360S has both balanced (XLR) analog outputs and single-ended (RCA) outputs. They are found on the outside edges of the rear panel. As viewed from the *front*, the left side contains the Left channel and the right side contains the Right channel. Use high quality analog cable such as Madrigal CZ Gel.

5 Select the input you are using by pressing its front panel button

6 Turn on the other components; slowly raise the volume

Congratulations! You should now be able to enjoy your favorite music while reading the rest of this manual.

Note:

It is always a good idea to turn on your power amplifier(s) last, in case one of your other components exhibits a turn-on transient of some sort. Similarly, when powering the system down (rather than simply using standby), turn off the power amplifier(s) first.

Warm up & break-in period

Although your Mark Levinson N°360S digital processor delivers outstanding performance straight out of the box, you should expect to hear it continue to improve as it reaches its normal operating temperatures and its various components stabilize. It has been our experience that the greatest changes occur within the first 25-50 hours, but that the N°360S will continue to improve in sound quality for about 300 hours, after which time it remains quite constant.

The only exception to this rule is if power is removed from the unit, allowing it to cool down. In this case you should expect a relatively brief warm-up period before the N°360S' sound quality is at its best.

Special Design Features

Congratulations on your purchase of the N°360S Digital Audio Processor. The Madrigal design team is confident you will enjoy the outstanding performance of the N°360S for many years. In case you are interested in technical details, what follows is a brief outline of some of the key technologies in your new processor.

“24/96” capability & HDCD®

In addition to the common 16 bit at either 44.1 and 48 kHz sampling rates used by digital sources such as CD and DAT, your N°360S also supports the two channel 24-bit/96 kHz signal that was defined as part of the DVD-Video standard (and which will certainly be included as part of a larger DVD-Audio standard when the industry agrees to such a thing). As of the writing of this manual, such “24/96” material is just beginning to become available, and we expect availability to grow quickly over time.

In addition to true 24-bit capability, the N°360S also incorporates High Definition Compatible Digital® decoding to take full advantage of the increased resolution available from HDCD-encoded 16-bit CDs. The High Definition Compatible Digital® format retains much of the resolution inherent in professional twenty bit recordings, by encoding this information more efficiently within the sixteen bit space available within the Compact Disc format.

Guarding against obsolescence

There are many promising technologies on the horizon, many or all of which may be included as part of a DVD-Audio disc standard. These technologies differ in many significant details, but they all promise revolutionary improvements in sonic quality. While such a DVD-Audio standard has not gotten past the draft form (as of the writing of this manual), we have gone to great lengths to design the N°360S to be able to accommodate new standards as they are introduced.

For example, we designed our own “digital interface receiver” that can be reprogrammed in software to receive and sort out many different types of digital transmissions. This is critically important, since the finest digital processor in the world is of little use if it cannot receive the desired signal in the first place.

Similarly, we have implemented both digital decoding and filtering in powerful, general-purpose Sharc DSP chips, rather than relying on purpose-designed chips that may well be obsolete as soon as a new format is introduced. These Sharc chips can perform a wide range of functions, including many that are not yet defined, simply by loading

new software as needed. In this respect, the N°360S is more like a modern computer in its architecture, whereas most audio processors are akin to mere appliances, designed to provide only a fixed set of functions.

Everything that the N°360S “knows” how to do is stored in non-volatile computer memory. Updating this “flash” memory to accommodate newly-announced formats of functions is a simple matter of connecting the N°360S’ RS-232 port on the rear panel to a PC and downloading new information. The process takes but a few minutes, and minimizes any chance of premature obsolescence for this fine product.

An “intelligent” FIFO

Unlike most processors which are highly dependent on the quality of the digital signal they are fed, the N°360S Digital Audio Processor delivers outstanding performance with even less-than-ideal digital signals.

“FIFO” stands for “First In, First Out.” It describes a simple buffer in which the digital information is stored temporarily on its way to being converted to analog. Just as a large water tower can provide a steady source of water to a small town, despite hour-to-hour variations in the supply of water from the well, a FIFO can provide a steady, consistent source of digital data to the converters which are responsible for changing that data into music. Even if there is significant “jitter” (inconsistencies in timing) in the incoming digital information, the output of the FIFO is controlled by a special clock with tremendous accuracy. The result largely eliminates the jitter and allows the musical information to be reproduced cleanly, without jitter-induced distortions.

The trouble with most FIFOs lies in their behavior when the incoming signal is poor enough to cause the “water tank” to overflow or to be emptied. Normally, a FIFO would then have to “invent” false data to fill the gap, throw away excess data, or revert to non-FIFO operation. None of these approaches is acceptable, as they all represent serious sonic compromises.

Of course, one could simply use an *extremely* large buffer. Unfortunately, this solution is a poor one.

A larger buffer implies a longer delay between when information goes in and when it starts coming back out. With laserdiscs, for example, you must keep the in/out delay small so as to keep the soundtrack synchronized with the picture on the screen. An oversized buffer would make every movie’s audio out of step with its video, an unacceptable situation. Of course, one could bypass the FIFO for movies, at the cost of losing all of its distortion-reducing benefits.

Madrigal engineers have developed a proprietary buffer management scheme which reduces reproduced jitter to less than 20 picoseconds while maintaining the synchronization of sound and picture in movies. It employs a buffer large enough to absorb the jitter found in transports of reasonable quality, yet small enough to have imperceptible delay. The rate at which data is released from the FIFO buffer is controlled by software to track the *long-term* data rate of the incoming signal, allowing the buffer to absorb all the short-term variations which cause sonic degradation. This approach yields a “smart” FIFO buffering scheme which rejects virtually all incoming jitter without requiring an enormous buffer and suffering the consequent audible delay. It also avoids the sonic penalties associated with the various strategies used when a buffer overflows or empties.

**Superior isolation
between sources**

One of the advantages of a separate digital audio processor is that you can take the money which might have otherwise been spent on several built-in D/A converters and put it into one, superior processor which will enhance the performance of all the transports with which it is used. Ironically, many outboard processors fail to live up to this potential due to interference between their various digital inputs.

The N°360S provides outstanding isolation between its inputs, realizing the full potential of the various digital transports with which it is used. In fact, all unselected digital inputs are disabled. As a result, the selected input effectively has the N°360S “all to itself” for its conversion to analog.

HDCCD[®] Gain-Matching

Some HDCCD-encoded recordings are mastered at a level which is noticeably lower (6 dB) than conventional recordings, to allow for greater dynamic peaks. To avoid unexpected changes in average volume when going from one disc to another, the N°360S can automatically reduce the volume of all recordings by six decibels. To remind you of when it is in this mode of operation, the N°360S will display “-6 dB PAD” when locking on a digital input signal in the **HDCCD AUTO** mode.

In our listening tests, we have determined that the only sonically transparent gain-matching technique is to *raise* the volume of the preamplifier by the requisite 6 dB when playing those discs that require it. ***All other design options introduce a compromise in sound quality.***

For Best Performance:

We strongly recommend that you use the HDCCD MANUAL gain-matching in your N°360S digital audio processor.

If you are using the N°360S with a Mark Levinson N°380 or N°380S preamplifier, simply name the appropriate input on the preamplifier “No36” (explained in the preamp manual), and connect the two products with a Communications Link cable. In this case, the N°360S will tell the preamplifier to change its volume setting as necessary to compensate for differing CD mastering techniques, and you never have to think about it. (*The preamp’s display will show “HD+6” to indicate a change required by the HDCCD recording being played through the N°360S; it will revert to normal and show “HD+0” when you return to conventional recordings. Older N°38 and N°38S preamplifiers may require a new EPROM to take advantage of this feature.*) This technique ensures that you always get the best possible sound from your system, without any unexpected changes in level, regardless of the recordings you play.

If you are using the N°360S with any other preamplifier, follow the steps below. (You will have to adjust the volume on some HDCCD recordings manually.)

1 Press and hold the mode button on the front panel

After a few seconds, the display will change to show **SET NAME** and the current name of the selected input. When you let go, it will show **NAME** and the current name of the input. (*Ignore this for now. You'll learn how to rename your inputs to match your sources later on in this manual.*)

2 press the polarity button so the display shows "HDCD MAN."

Repeatedly pressing the polarity button will toggle the display between "**HDCD AUTO**" (*meaning that the N°360S automatically lowers its volume on conventionally-mastered discs*) and "**HDCD MAN.**" (*meaning that gain-matching is turned off; HDCD-encoded discs will still be decoded properly*). If you try to change from one to the other while a N°380 is Linked, the N°360S will display "**HDCD No38**" (indicating that the equipment already knows what to do).

Using manual gain-matching ensures that the HDCD digital filter always operates at its maximum resolution, although you may now have to manually turn up the volume on some HDCD recordings, beyond your usual settings.

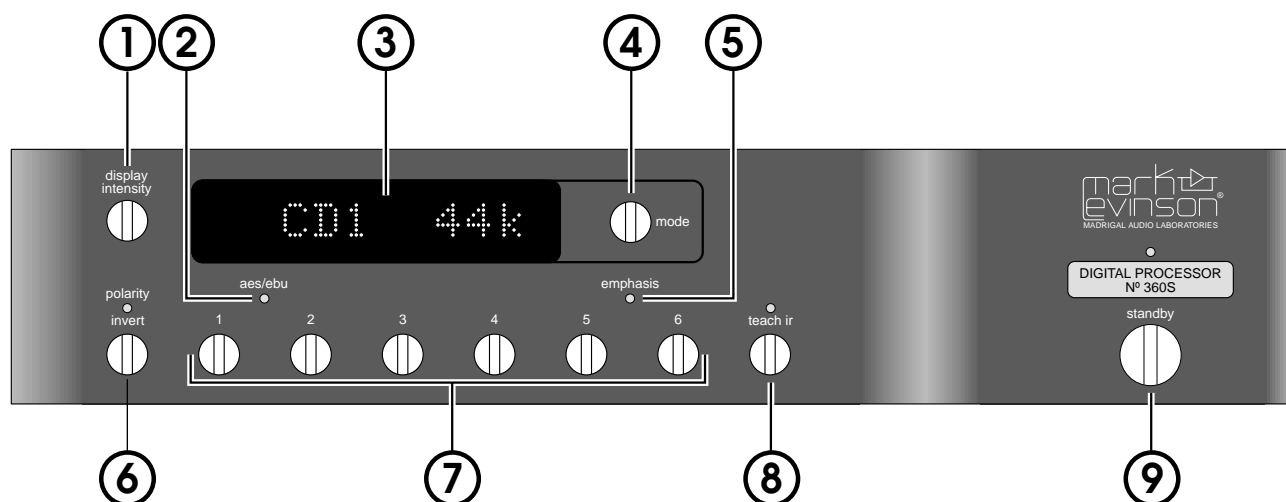

Front panel, N°360S

1 display intensity

Pressing this button varies the brightness of the **display**. Four brightness levels are available.

When power is first applied to the N°360S (or when power is restored after an interruption), the **display** is automatically set to its brightest level.

Pressing the **display intensity** button once dims the **display** one level; pressing it again dims it further; pressing it again turns the **display** off. Pressing **display intensity** once more returns the **display** to its brightest level. (If other Mark Levinson components in the system are “Linked” to the N°360S, all display intensities will change in unison. See *Linked Functions* for more information.)

2 aes/ebu LED

The **aes/ebu LED** lights when the N°360S detects that the digital program being processed conforms to the AES/EBU (*Audio Engineering Society/European Broadcast Union*) professional standard. This LED indicates the presence or absence of certain encoded information in the digital signal. It does *not* indicate that the AES/EBU connections (a connection standard written by the same group) are being used. Playback of non-AES/EBU CDs or DATs won't activate the **aes/ebu LED**, even if the associated transport is connected according to the AES/EBU standard.

3 Display

See “Display, N°360S” beginning on page 20.

4 mode button

The mode button serves two functions, one in day-to-day operation and the other only during setup:

- In everyday use, the **mode** button allows you to see the status of the **digital output** and to turn it on or off.
- During setup, the **mode** button allows you to rename the various inputs of the N°360S to suit the needs of your system, making it easier to use (especially for those who use the system infrequently). It also allows you to toggle the HDCD volume adjustment between Automatic and Manual.

To check on whether your selected input is present at the digital output, press **mode** once. This action causes the display to indicate whether the digital record output is on or off. For example, the display shown below indicates that the digital record output is on.



To disable the digital record output, press the **mode** button again (while **RCD: ON** remains displayed). The display will read **RCD: OFF** and the digital output of the N°360S will be temporarily disabled. This eliminates any potential interaction between the record output circuitry of the N°360S and the rest of your system. Repeatedly pressing the **mode** button while **RCD:** shows in the left half of the display will toggle the N°360S between **RCD: OFF** and **RCD: ON** for the selected source.

After a few seconds, the display will return to its normal mode, which is to display the selected source and current sampling frequency.

To toggle between **HDCD Auto** gain (*thereby lowering the volume of non-HDCD sources by 6 decibels, relative to an HDCD source*) and **HDCD Manual** gain (*requiring you to make appropriate volume adjustments as you see fit, but avoiding any digital attenuation*), enter the setup mode by *pressing and holding* the **mode** button until the input name for the currently selected input is displayed. Then toggle the HDCD setting using the **polarity invert** button. The unit will time out after a few seconds and your change will be saved for all inputs. (*Note: the N°360S will return to its default setting of HDCD Auto after a loss of power.*)

5 **emphasis LED**

The compact disc standard, as created by Sony and Philips, allows a high-frequency boost to be employed during recording. This boost, called recording pre-emphasis, increases the signal-to-noise ratio at high frequencies, but must be countered by a high-frequency cut before playback to restore a recording's normal frequency response. De-emphasis may be done as the recording is being mastered, or the compact disc (or digital audio tape) may be made with the pre-emphasis still on, and the de-emphasis performed in the playback unit.

The **emphasis LED** lights when the N°360S detects recording pre-emphasis in the digital program being processed, and subsequently employs its de-emphasis circuitry. In the N°360S, the de-emphasis filtering is done in the digital domain.

17

Note: The de-emphasis circuitry of the N°360S is designed to be compatible with all known digital standards. However, it is possible for the emphasis LED to light in error when there is no disc being played. This is not a malfunction of the N°360S. Rather, it is the result of the transport generating ambiguous signals in the absence of a spinning disc to read. You may never see this condition. Even when the condition exists, it has no effect on sonic quality, as it can only occur when there is no disc playing.

6 **polarity invert**

Pressing this button inverts the polarity of the digital signal, to compensate for polarity differences during the recording process. Some recordings may simply “sound better” when this function is active.

While **polarity invert** is selected, the LED above the button will light.

Note: **polarity invert** doesn't affect the digital output, and isn't available for inverting the polarity of digital signals to be recorded.

Note: **polarity invert** may be operated by infrared remote control when the N°360S is connected to compatible Mark Levinson components such as the N°31 Reference CD Transport. Complete instructions are included in those components' operating manuals. Alternatively, the N°360S can "teach" a learning remote control infrared control codes that will provide similar functionality. (See "Remote Control of the N°360S")

7 Source selection buttons

Pressing any of these buttons selects the digital source associated with that numbered input, according to the connections on the rear panel (see "Rear panel, N°360S"). The display will show the name of the input, along with the input number. (See "Setup and Installation" for more information on naming your inputs to match your sources.) Only one source at a time may be selected.

When power is first applied to the N°360S (or when power is restored after an interruption), it will search for and select the first input with an active digital signal. If none is found, it will select the first named source. As delivered from the factory, this input will be "CD1."

When the N°360S is taken out of standby mode, the source last selected before pressing **standby** will be automatically selected.

power user tip:

Press and hold the active input button to have the processor display the output format information, e.g., the bit depth and rate at which digital audio is being converted to analog. This indicates the degree to which the incoming signal has been "upconverted" for improved performance. Another press of the button will revert to displaying the normal input name and rate.

8 Teach IR

The N°360S has both an infrared receiver and an infrared transmitter in its main display, enabling it to respond to IR remote controls that have "learned" the appropriate commands. The N°360S can "teach" these commands to a learning remote control.

For more information on using the teach ir function of the N°360S, see “*Remote Control of the N°360S*”

9 Standby & Standby LED

Pressing this button takes the N°360S out of “standby” mode (provided the N°360S is connected to AC power), making it fully operational.

Pressing **standby** again places the N°360S into standby mode, which turns the **display** off, turns off all outputs (including the record outputs), and disables the front-panel controls. The internal circuitry remains powered up in order to maintain its thermal stability and optimum performance at all times.

While the N°360S is in standby, the LED above the **standby** button flashes approximately every five seconds. When the N°360S is ready to operate (that is, when it is not in standby mode), this LED remains lit continuously.

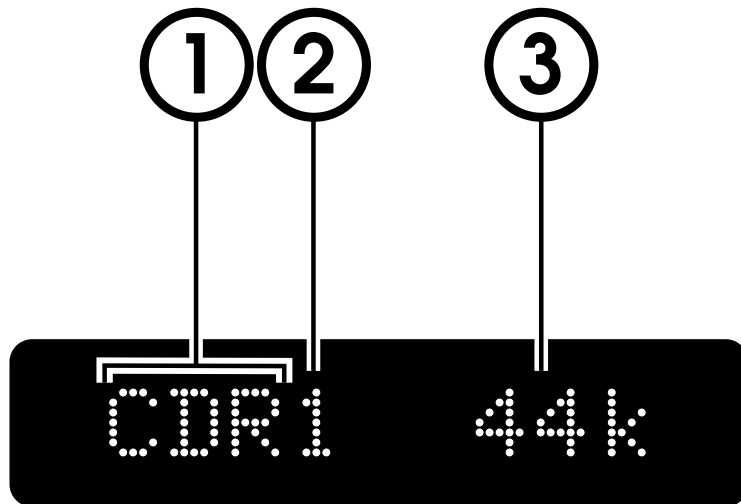

Display, N°360S

1 Input Name

This part of the N°360S' **display** shows the **name** of the input selected, as determined during setup (see "Assigning input names" in the "Installation" section of this manual).

To facilitate operation in complex, multisource systems, the N°360S is capable of displaying a wide variety of names for each of its eight inputs. They are listed below.

NOT USED	(any unused input)
CD	Compact Disc
DVD	Digital Video (or "Versatile") Disc
LD	Laser Disc
DAT	Digital Audio Tape
DCC	Digital Compact Cassette
MD	Mini Disc
CDR	Compact Disc, Recordable
CDI	Compact Disc, Interactive
DBS	Direct Broadcast Satellite
DSS	Digital Satellite System ("DirecTV" or "USSB")
AUX	Auxiliary (other digital sources)
DCR	Digital Cable Radio

2 Input number

This part of the N°360S' display shows the **input number** of the selected digital source, according to the connections on the rear panel (see "Rear panel, N°360S") and to the front panel button used to access that input.

3 Sampling frequency

This part of the N°360S' display normally shows the **sampling frequency** of the digital input being processed, expressed in kilohertz. The digital sampling frequency of the incoming signal will be shown, in "shorthand" form: **32k**, **44k**, **48k**, or **96k** (44k is shown in the main illustration on the opposite page). When an HDCD® signal is being received and decoded, this area will show **HDCD** instead of a sampling frequency.

After you press one of the source selection buttons (say, going from input 1 to input 5), the N°360S will reduce the volume and the display will show:



21

While the N°360S is attempting to lock onto a different digital signal, the display will show (*assuming you have renamed input 5 for your DAT*):



If no digital signal is present (if the source is turned off, is improperly connected, or is disconnected), the display will show:



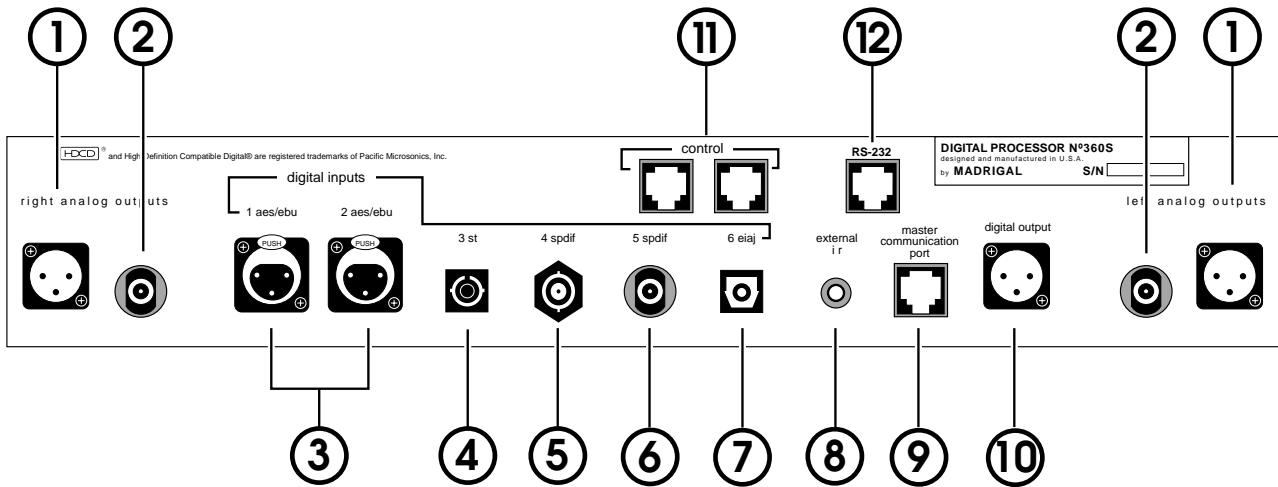

Rear panel, N°360S

1 balanced analog outputs

These outputs provide balanced line-level analog audio (via cables equipped with XLR-type connectors) to a preamplifier, integrated amplifier, or receiver equipped with balanced inputs (see “Set-up and installation”). The pin assignments used are AES-standard, as shown below:

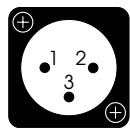

- Pin 1: Signal ground
- Pin 2: Signal + (non-inverting)
- Pin 3: Signal – (inverting)
- Connector ground lug: chassis ground

Please use high quality balanced interconnecting cables such as Madrigal CZ Gel-1 with these outputs (assuming your preamplifier supports balanced inputs).

2 single-ended analog outputs

These outputs provide single-ended line-level analog audio (via cables equipped with RCA-type connectors) to a preamplifier, integrated amplifier, or receiver. Please use high quality single-ended interconnecting cables such as Madrigal CZ Gel-2 with these outputs (assuming you use them rather than the balanced outputs in 1 above).

3 **aes/ebu electrical digital inputs (#1 & #2)**

These inputs accept the **digital audio signal (DAS)** via cables equipped with XLR-type connectors from digital sources such as a compact disc transport, DVD transport, laser disc transport, digital audio tape transport, or digital broadcast receiver.

These inputs conform to the AES/EBU digital interconnection standard, which calls for a 110Ω transmission of the DAS. Use a digital interconnecting cable specifically designed for the 110Ω AES/EBU standard, such as Madrigal MDC-1 cable, when using these inputs. The pin assignments for the AES/EBU digital interconnection standard are shown below.

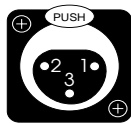

Pin 1: chassis ground

Pin 2: non-inverted digital

Pin 3: inverted digital

Connector ground lug: chassis ground

4 **ST optical digital input (#3)**

This input accepts the **digital audio signal (DAS)**, via optical cable equipped with the ST-type optical connector (sometimes called “AT&T”) from digital sources such as a compact disc transport, laser disc transport, digital audio tape transport, digital broadcast receiver.

23

5 **BNC S/PDIF electrical digital input (#4)**

This input accepts the **digital audio signal (DAS)** via cables equipped with BNC-type connectors from digital sources such as a compact disc transport, laser disc transport, digital audio tape transport, digital broadcast receiver.

This input conforms to the Sony/Philips Digital Interface Standard (S/PDIF), which calls for a 75Ω transmission of the DAS. Use a digital interconnecting cable specifically designed for the 75Ω S/PDIF standard, such as Madrigal MDC-2 cable, when using this input.

6 **RCA S/PDIF electrical digital input (#5)**

This input accepts the **digital audio signal (DAS)** via cables equipped with RCA-type connectors from digital sources such as a compact disc transport, laser disc transport, digital audio tape transport, digital broadcast receiver.

This input conforms to the Sony/Philips Digital Interface Standard (S/PDIF), which calls for a 75Ω transmission of the DAS. Use a digital interconnecting cable specifically designed for the 75Ω S/PDIF standard, such as Madrigal MDC-2 cable, when using this input.

7 EIAJ optical digital input (#6)

This input accepts **digital audio signal (DAS)** via optical cable equipped with the EIAJ optical connector (sometimes called “Toslink™”) from digital sources such as a compact disc transport, laser disc transport, digital audio tape transport, digital broadcast receiver.

8 External IR Input

The N°360S incorporates an infrared repeater input to facilitate a wide range of installation options. If desired, the N°360S may be placed inside a cabinet or outside the normal line-of-sight in the listening area, with the controlling IR signal being relayed to the N°360S by any of a number of commercially-available IR repeaters.

The specifications for this IR input call for a triggering voltage of 5 volts at no more than 100 milliamps of current, with the tip of the $\frac{1}{8}$ " mini-plug having positive polarity, as below:

IR input tip polarity

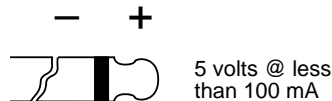

If you would like more information on the possibility of using an infrared repeater with your N°360S, please contact your Mark Levinson dealer.

9 Master communication port

This communications port allows the N°360S to “link” to certain compatible Mark Levinson components. (See “*Linked Functions.*”)

Linking connections

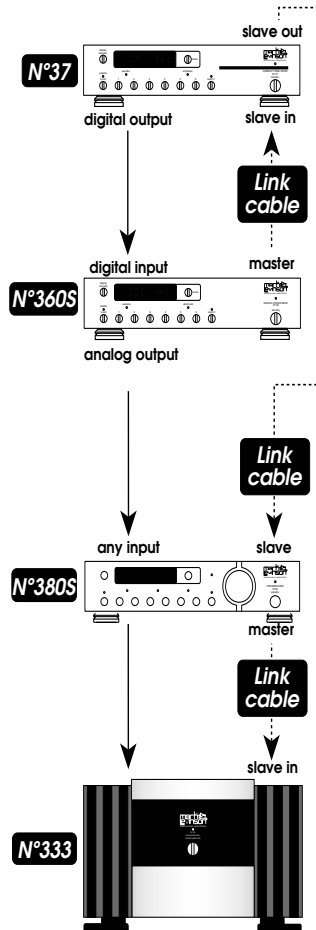

The Mark Levinson Linking system uses the N°360S as the Master of (and central clearinghouse for) inter-component communications. Other components such as digital transports are connected to the Master as “Slaves,” and can be “daisy-chained” using their Slave In and Slave Out jacks. As the ultimate destination of all source signals, the N°380 or N°380S Preamplifier (if owned) *must* be the final “Slave” in the chain. (*In technical terms, it terminates the communications bus.*) In turn, the N°380 can then serve as a master to an associated compatible Mark Levinson power amplifier—hence its “Master” communications port.

Thus, if the only other Mark Levinson Link-compatible component you have is the N°380 or N°380S, connect the N°360S’ master port to the preamplifier’s slave port using a “straight-through” RJ-45 cable. If there are additional Mark Levinson Link-compatible components in the system, place the preamplifier at the end of the chain by connecting the last slave out port to the N°380’s slave port. See the diagram at left for clarification.

The RJ-45 cable needed for the Link connection between the N°360S and other Link components may be purchased from your Mark Levinson dealer. It may also be easily and inexpensively made to length using two RJ-45 connectors and the appropriate length (up to 100 feet/30 meters) of RJ-45 (flat, eight conductor) cable.

RJ-45 cables and connectors are used throughout the world for both telecommunications and computers, and are widely available at low cost. The connectors are crimped on to the ends of the cable such that pin 1 at one end is connected to pin 1 at the other end. Such a “straight-through” connection is (counter-intuitively) made by introducing a 180° twist in the cable between the two ends, as shown below.

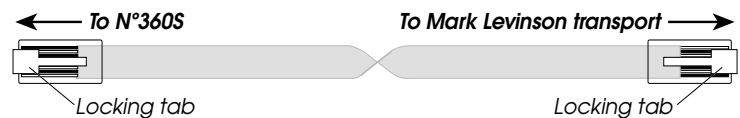

Building link cables

Caution!

Connecting the communication ports other than as described in this manual may damage the N°360S and the associated Mark Levinson components, and will void those products’ warranties.

Male XLR output
connector (digital)

10 electrical digital output

This output provides **digital audio signal (DAS)** via cables equipped with XLR-type connectors to a digital processor, digital audio tape recorder, preamplifier, integrated amplifier, or receiver equipped with XLR-type digital inputs.

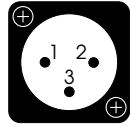

Pin 1: Chassis ground

Pin 2: non-inverting DAS

Pin 3: inverting DAS

Connector ground lug: chassis ground

This **digital output** is enabled or disabled by the **mode** button, and when enabled makes a copy of the DAS of the currently selected input available to other components. It employs the **110Ω AES/EBU** transmission standard.

11 PHASTLink® Control ports

In addition to the Mark Levinson Linking system described above, the N°360S can, as an extra-cost option, support the PHASTLink® communications system. This system is designed to facilitate complete systems integration with PHAST® controllers. For more information on PHAST® (a division of AMX®), please refer to the internet at <http://www.phast.com>.

12 RS-232 Port

The N°360S also includes an RS-232 port, which may be used in conjunction with external control systems such as Audioaccess, AMX, or Crestron. Your dealer can assist you in taking advantage of these advanced features.

This RS-232 port may also be used to update the operating software of the N°360S, so that your system will be able to handle new digital audio formats as they are introduced. (Think of updating the software in the N°360S as being like installing new software in your computer... only much less painful.) Once again, your dealer can assist you in taking advantage of these advanced features, should the need arise.

The “pinout” connections used on the RJ-11 connector used for the RS-232 port is as follows:

RS-232



pin 2 = Rx from PC
pin 3 = Tx to PC
pin 5 = ground

Note that only qualified technicians should attempt to make use of the special capabilities afforded by this communications port.

AC power connector (on bottom)

This input accepts AC power from the AC mains (via the supplied AC cable).

Connect the female end of this cable to the N°360S. Connect the male end of this cable to wall outlet or to an “unswitched” convenience outlet like those found on many audio components.

AC power cord polarity

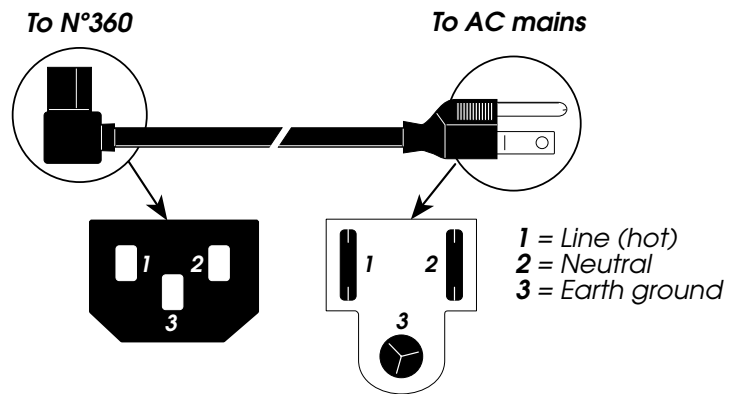

Setup and Installation

Caution!

For your protection, review “Important Safety Instructions” before you install your N°360S.

N°360S Input Names

The N°360S allows you to assign any of a wide variety of names to each of the eight digital inputs, shown below:

NOT USED	(any unused input)
CD	Compact Disc
DVD	Digital Video (or “Versatile”) Disc
LD	Laser Disc
DAT	Digital Audio Tape
DCC	Digital Compact Cassette
MD	Mini Disc
CDR	Compact Disc, Recordable
CDI	Compact Disc, Interactive
DBS	Direct Broadcast Satellite
DSS	Digital Satellite System (“DirecTV” or “USSB”)
AUX	Auxiliary (other digital sources)
DCR	Digital Cable Radio

The name you assign to an input is shown on the **display** when a source is selected (see “Display, N°360S”). Before operating your N°360S, you’ll want to customize it to match the digital sources in your system.

The N°360S digital audio processor is shipped with inputs 1 and 5 named CD, since you will probably want to hook up your new component and start using it right away. CD1 is an AES/EBU (XLR) digital input, and CD5 is a S/PDIF (RCA) digital input, and both are ready for use as soon as the N°360S is powered up and connected to the rest of the system. (See “Making Digital Connections” and “Making Analog Connections” below.) Other inputs are named NOT USED and must be renamed before they may be used.



Important!

Any input named NOT USED cannot be used to convert digital signals to analog until its name has been changed.

Making Digital Connections

The N°360S incorporates **RCA**, **BNC** and **XLR** electrical connectors, and **ST** and **EIAJ** optical connectors for digital audio signal input. The digital output is the electrical **AES/EBU** standard via **XLR** connector. (See “Rear panel, N°360S,” above.)

Unlike previous generations of digital audio processors, the performance of which was highly dependent on the digital interface and the digital interconnect, the technology of the N°360S allows it to deliver optimal performance despite the inherent limitations of interfaces such as the **EIAJ** standard (sometimes called “Toslink™”). As a consequence, you can feel free to use whichever interconnection standard is convenient, given the provisions of your various digital sources.

For electrical digital interconnection, we recommend Madrigal MDC cable. MDC-1 is designed for 110Ω AES/EBU interconnection (via XLR connectors); MDC-2 is designed for 75Ω s/PDIF interconnection (via either RCA or BNC connectors). Both cables are available in various lengths from your Mark Levinson dealer.

Using appropriate cables, connect all your digital source components to suitable inputs on the rear panel of the N°360S processor. If you have several such components, you might want to make a note of which component is plugged into which input on a piece of scrap paper. (You will rename the various inputs in the N°360S shortly, making it easier to remember which input goes with which transport once the installation is complete.)

29

If you have several digital sources which have only s/PDIF (RCA or BNC) outputs, it is possible to use an RCA-to-XLR cable for connection to one of the N°360S' XLR-type digital inputs. For the best performance in these circumstances, we recommend using a high-bandwidth (300 MHz), three conductor, 110Ω cable such as Madrigal MDC-1 (available from your Mark Levinson dealer). You may also fashion one according to the diagram below.

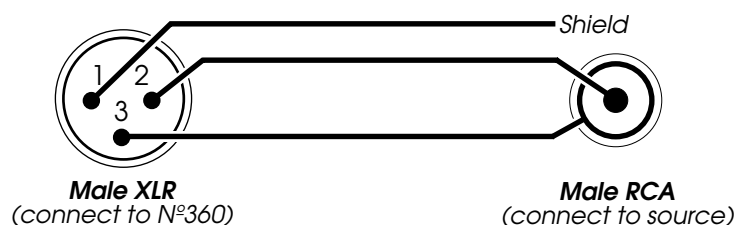

Making Analog Connections

The N°360S includes one set of balanced and one set of single-ended analog outputs. The balanced outputs are generally preferred for their superior immunity to noise. All outputs operate at a line level.

Note: the standard line level for balanced interconnection is six decibels higher than for single-ended interconnections.

Please use a high quality cable for your analog audio interconnection. We recommend you at least audition Madrigal CZ Gel Interconnect Cable:

- CZ Gel-1 is a purpose-designed balanced interconnecting cable (and what we use here at the factory for most of our listening tests);
- CZ Gel-2 is a purpose-designed single-ended interconnecting cable (and what we use here for single-ended listening).

Using whatever high quality cable you choose, connect the appropriate output of the N°360S to an input of your preamplifier. The output impedance of the N°360S is extremely low, which allows you to use more than one output simultaneously without seriously degrading performance, should you have any reason to do so. For example, you might supply a multi-room system with the signal of the N°360S as well as your main music system. Note, however, that only one digital source may be converted to analog at a time.

Making Link Connections

The N°360S incorporates sophisticated inter-component communications capabilities when Linked to compatible Mark Levinson components. (See “Communications Ports” in “Rear Panel.”) If you own compatible Mark Levinson digital source components or preamplifiers, connect them to the N°360S with an eight-conductor RJ-45 cable as described on page 25. You may find that you need to cycle power off and on once after making or changing connections, in order to ensure that all components in the chain are aware of each other’s presence and location. Engaging **PLAY** on the transport once from **STOP** will complete the Link connection by activating the communications bus between the components.

Making PHASTLink Connections

These two communications ports provide for sophisticated inter-component communications between the N°360S and other compatible Madrigal products. To access the built-in intelligence of these communications capabilities, simply “daisy chain” your various PHAST™-ca-

pable Madrigal components together using eight conductor “straight-through” cables with RJ-45 connectors at both ends.

The RJ-45 cable needed for the connection between the N°360S and other PHAST-compatible Madrigal components may be purchased from your Mark Levinson dealer. It may also be easily made to length using two RJ-45 connectors and the appropriate length (up to 100 feet/ 30 meters) of RJ-45 (flat, eight conductor) cable.

RJ-45 cables and connectors are used throughout the world for both telecommunications and computers, and are widely available at low cost. The connectors are crimped on to the ends of the cable such that pin 1 at one end is connected to pin 1 at the other end. Such a “straight-through” connection is (counter-intuitively) made by introducing a 180° twist in the cable between the two ends, as shown below.

Building PHAST cables

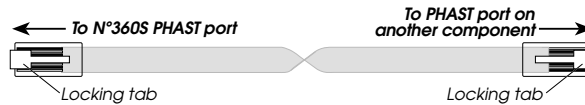

Connecting the communication ports other than as described in this manual may damage the N°360S and the associated components, and will void those products' warranties.

31

These ports also provide for extensive home automation flexibility via the PHAST™ protocols, should you be interested in integrating other brands of products into the system in a more comprehensive control system. Your dealer can assist you in taking advantage of these advanced features.

Input Names

Each input of the N°360S digital processor can and should be named to match the source connected to that input. Doing so makes it easier to remember which components are accessed by which buttons (especially for the occasional user).

To facilitate operation in complex multisource systems, the N°360S is capable of displaying a wide variety of alternative names for each of its six inputs. All inputs other than 1 and 5 are labelled **NOT USED** as delivered from the factory, and will need to be given appropriate names before they may be used. Giving inputs appropriate names is simple and greatly enhances the ease of use of your new N°360S, especially for oc-

casual users of the system. The available names are shown on page 28.

Each name is normally followed by a number corresponding to the number of the input being used. Thus, a DAT in Input 3 would normally display a **DAT3**. In this way, you can have more than one CD player, for example, and still tell at a glance which one is selected.

Mark Levinson transports will automatically pass their proper names on to the Linked digital processor if their Name Link (or “Alias Link”) is turned on at the transport. For example: when selected, an input that has a Mark Levinson N°31 connected to it will show **No31** in the display (rather than a more generic **CD1**).

Detailed instructions for changing names are given below. As a quick overview: to change names for inputs on the N°360S, you enter the setup mode by pressing and holding the **mode** button for several seconds; then you change the name; then you confirm the new name by pressing and holding the **mode** button *again* for several seconds. (This rather deliberate process minimizes the chance that something will be changed accidentally by the casual user of the system.)

Naming Your Inputs

To give an input a new name:

1 Select the input you wish to rename

Note that the input to be renamed needs to be selected prior to naming.

2 Press and hold the mode button

After a delay of approximately five seconds, the display will change to **SET NAME**), as shown below.



SET NAME

When you see this message in the display, you can release the **mode** button, at which time the display will show the current name of the selected input.

3 press the selected input's button repeatedly until you see the name you wish to use

This action will cause the display to cycle through the list of available names, with the input number appended to the end of each name. For example, you might wish to change input #6 from **NOT USED** to **LD6** if the digital output of your laserdisc player is plugged into the EIAJ input. In this case the display would appear initially as follows:



and you would cycle through the various names until you saw:



33

4 Press and hold the mode button To the confirm change

Pressing and holding the **mode** button a second time confirms that you would like to make this change, that it is a conscious choice (rather than an accidental change caused by an inquisitive four year old):



If no change is made, the display will show:



5 Repeat this process for all inputs

Remote Control of the N°360S

The N°360S includes both an infrared receiver and an infrared *transmitter*. With this capability, it can “teach” a learning remote control any commands that might be needed for remote operation. These include input selection, mode, polarity, etc.

Specifically, the N°360S can send all of the necessary IR commands from its **display** window, enabling you to teach a learning remote any or all of its pre-programmed commands, as well as some optional special commands that are available to solve specific installation-related problems.

The N°360S has two special modes of operation into which it may be placed in order to facilitate the “teaching” of remote control commands to a learning remote control. The first allows you to easily teach the commands for which there are corresponding front panel buttons. The second allows you to teach “special” commands to the remote control for which there are no corresponding front panel buttons.

34

Teaching N°360S Front Panel Commands

1 Press the “teach IR” button to enter the teaching mode

The LED above the **teach ir** button will illuminate and the display will read **< IR MODE** to indicate that the N°360S is ready to teach a learning remote control the infrared commands that correspond to the its front panel buttons. (Pressing the **teach ir** button a second time will return the N°360S to normal operation if you change your mind.)

2 Press any front panel button to cause the N°360S to send the corresponding IR command

Line up the IR window of your remote control with the left side of the N°360S display (being pointed at by the **< IR MODE** in the display), at a distance of approximately 1"-3". Select the to-be-learned button on the remote, then press the corresponding button on the N°360S to fire the appropriate IR code. The display will change to read **^ IR MODE** to indicate that the IR code is being emitted, then will revert to **< IR MODE** when it is ready to teach the next command. (*Tip: most learning remotes need to be held fairly still while they learn new IR commands; movement can garble the received IR.*)

If you are uncertain as to how to prepare your remote control for learning new commands, refer to the instructions provided with the remote control.

- 3 **Repeat the process of “teaching” new commands to the various buttons on your remote control until all front panel commands have been learned by your remote**
- 4 **When finished, exit the programming mode by pressing the teach ir button**

You may wish to teach your remote control some of the N°360S’ special commands (those for which there is no corresponding front panel button); in this case, you should go directly to the next section. At some point, however, you should test all your newly “learned” commands to ensure that they were “learned” correctly.

Teaching Other N°360S Commands

As mentioned above, the N°360S has the capability to teach learning remote controls special commands for which there are no front panel counterparts. These commands can be especially helpful in solving problems in certain kinds of custom installations.

These “hard assignment” commands in the N°360S will place it into a certain mode of operation regardless of its current state. For example, a hard assignment command to enter **standby** will *leave* the N°360S in **standby** if already there, or *switch* it to **standby** if it is currently operating. This type of hard assignment command is especially helpful when you do not necessarily know the current status of the N°360S, as might be the case in a multi-room home entertainment system (for example).

35

- 1 **Press and hold the teach ir button until “<IR CMD1” appears in the display**

A momentary press of the **teach ir** button will, of course, simply get you ready to teach front panel button commands, as discussed in the last section. When you “camp on” the **teach ir** button instead, the N°360S will wait for a few seconds to make sure that your press-and-hold action is quite deliberate, and then enter a teaching mode for its “special” commands. If no further buttons are pressed within approximately ten seconds, the N°360S will “time out” and return to normal operation.

- 2 **press the teach ir button repeatedly until the desired command number appears in the display**

The table below lists the special commands that are available for the N°360S. In the second column are the commands numbers used in the display to represent those special commands.

hard assignment for operate	CMD1
hard assignment for standby	CMD2
hard assignment for system operate	CMD3
hard assignment for system standby	CMD4
hard assignment for record on	CMD5
hard assignment for record off	CMD6
display intensity to off	CMD7
display intensity to medium	CMD8

3 Momentarily press the mode button to transmit that code

Line up the IR window of your remote control with the left side of the display of the N°360S, at a distance of approximately 2"-6". Select the to-be-learned button on the remote, then fire the selected code from the N°360S by pressing **mode**.

(If you are uncertain as to how to prepare your remote control for learning new commands, refer to the instructions provided with the remote control.)

5 Repeat the process of "teaching" new special commands until all desired commands have been learned by your remote control.

If you take longer than approximately ten seconds between button pushes, the N°360S will time out and return to normal operation. If this occurs, return to step #1 in this section.

6 When finished, Return to normal operation by allowing the N°360S to "time out"

The N°360S will "time-out" and return to normal operation after approximately ten seconds, or you can force it back to normal operation by "camping on" the **teach ir** button.

Linked functions

The N°360S has the ability to “link” several of its functions to compatible Mark Levinson components (like the N°31 Reference CD Transport and the N°38 or N°38S Preamplifier, and the 30-series power amplifiers).

Note: To take advantage of linked functions, you must connect the N°360S to the other components via their communication ports. (See “Rear panel” and “Set-up and installation.”)

The following linked functions are selected as operational options *at your Mark Levinson transport*. They are described here for your reference.

Standby link

- **Standby link:** This feature links the standby modes of the various Mark Levinson Linked components. For example:
 - If transport, digital processor, preamplifier and power amplifier are in standby mode, pressing the transport’s **standby** button will take all four components out of standby mode (making them ready to use).
 - If transport, digital processor, preamplifier and power amplifier are in standby mode, pressing the N°360S’ **standby** button will bring only the preamp out of standby mode (presuming that you may wish to use the N°360S with some digital source other than the Mark Levinson transport).
 - If transport, digital processor, preamplifier and power amplifier are “on” (not in standby mode), pressing the preamp’s **standby** button will place all four components into standby mode.

Name link

- **Name link:** The Mark Levinson digital transport’s alias link automatically overrides the name setting for its input. When you select the N°31’s input, the N°360S will show **No31** on its display.

Play link

- **Play link:** When you press the Mark Levinson digital transport’s **Play** button, this link automatically selects the appropriate input on the N°360S, and on the N°38 or N°38S.

Note: If you’ve connected the N°31 to two or more of your N°360S’ inputs, the play link will look first for AES/EBU interconnection, then ST, then S/PDIF, and finally EIAJ.

Display link

■ **Display link:** This links the **display intensity** functions of the N°360S and the other Linked components. When the components are linked, all displays will be set to the same brightness. Pressing **display intensity** on either component will affect both displays.

Polarity link

■ **Polarity link:** This links the **d/a polarity** button on the transport's Remote Control to the **polarity invert** function of the N°360S. The polarity link also allows inverted polarity to be saved with a program, via the N°31.

Troubleshooting

In general, refer any service problems to your Mark Levinson dealer. Before contacting your dealer, however, check to see if the problem is listed here. If it is, try the suggested solutions. If none of these solves the problem, contact your Mark Levinson dealer.

1. The N°360S won't function, and the Display is dark.

- ✓ The standby button on the front panel isn't turned on.
- ✓ The N°360S isn't plugged into the AC mains.
- ✓ The wall socket, adapter, or extension cord is faulty.
- ✓ There's a tripped circuit breaker or blown fuse in the wall outlet's circuit.
- ✓ A fuse is blown in your N°360S (contact your Mark Levinson dealer).

2. The Display is Lit, but there is no output

- ✓ The proper source isn't selected on your N°360S.
- ✓ The proper source isn't selected on your preamplifier.
- ✓ The interconnecting cables are connected incorrectly or are faulty.

3. The N°360S display reads "CD1 OFF:"

- ✓ The selected digital source component for Input #1 is turned off.
- ✓ The digital connection between the digital source and the N°360S is faulty.

4. The linked functions don't work.

- ✓ The Link cable is disconnected, or is connected incorrectly.
- ✓ The digital audio cable is disconnected, or is connected incorrectly (in which case the Display Link function would continue to work correctly, but none of the others would work).
- ✓ Try turning off/disconnecting AC power from both the transport and the N°360S. After several seconds, restore AC power to the digital processor, *then* turn on the N°31's **main power** switch.
- ✓ You may have older versions of the system software in your associated Mark Levinson components which do not fully support all Linked functions. Contact your Mark Levinson dealer with the model and serial numbers of your Mark Levinson components. If needed, new EPROMs will be provided at no charge.

5. I have a 24/96 DVD that will not lock and play at 96k

- ✓ When invoked, the CSS copy-protection system on DVD requires the transport either to mute its digital output entirely or to downsample (to a maximum of 16 bits/48 kHz). Conveying the full 24/96 digital material out of a transport when the CSS flag has been invoked a violation of copyright, and illegal. It may be that you are trying to listen to a disc which invokes CSS. Depending on your transport, the result will probably either be a 48k lock (indicating downsampling in your transport due to CSS), or no output at all (either “No DAS” or digital silence, again due to CSS and how it is implemented in your transport).

Care and maintenance

To remove dust from the cabinet of the N°360S, use a feather duster. To remove dirt and fingerprints, we recommend isopropyl alcohol and a soft cloth.

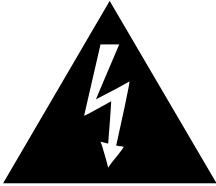

Caution!

Always apply the isopropyl alcohol to the soft cloth and then wipe the N°360S with the dampened cloth. Never pour even small amounts of any liquid directly on the N°360S, as doing so may allow the liquid to reach the circuitry inside the unit. Any liquid inside the unit poses a hazard to both the user and to the unit, and must be avoided.

U.S. and Canadian Warranty

90-Day Limited Warranty

This Mark Levinson® product is warranted to be free from defects in material and workmanship under normal use for a period of ninety (90) days from the date of purchase. **To extend the warranty of this Mark Levinson product**, return the warranty registration card along with a copy of the original receipt of purchase to Madrigal Audio Laboratories, Inc., P. O. Box 781, Middletown, CT 06457.

Five Year Extended Warranty

The *extended warranty* for this Mark Levinson product is **five (5) years** from the date of purchase. During the warranty period, any Mark Levinson component exhibiting defects in materials and/or workmanship will be repaired or replaced, at our option, without charge for either parts or labor, at our factory. The warranty will not apply to any Mark Levinson component that has been misused, abused or altered.

Any Mark Levinson component not performing satisfactorily may be returned to the factory for evaluation. Return authorization must first be obtained by either calling or writing the factory prior to shipping the component. The factory will pay for return shipping charges only in the event that the component is found to be defective as above mentioned. There are other stipulations that may apply to shipping charges.

There is no other express warranty on this component. Neither this warranty nor any other warranty, express or implied, including any implied warranties of merchantability or fitness, shall extend beyond the warranty period. No responsibility is assumed for any incidental or consequential damages. Some states do not allow limitations on how long an implied warranty lasts and other states do not allow the exclusion or limitation of incidental or consequential damages, so that the above limitation or exclusion may not apply to you.

This warranty gives you specific legal rights, and you may also have other rights which vary from state to state. **This warranty is applicable in the United States and Canada only.** Outside of the U.S. and Canada, please contact your local, authorized Mark Levinson distributor for warranty and service information.

Obtaining Service

We take great pride in our dealers. Experience, dedication, and integrity make these professionals ideally suited to assist with our customers' service needs.

If your Mark Levinson component must be serviced, please contact your dealer. Your dealer will then decide whether the problem can be remedied locally, or whether to contact Madrigal for further service information or parts, or to obtain a Return Authorization. The Madrigal Technical Services Department works closely with your dealer to solve your service needs expediently.



Important!

Return authorization must be obtained from Madrigal's Technical Services Department BEFORE a unit is shipped for service.

It is extremely important that information about a problem be explicit and complete. A specific, comprehensive description of the problem helps your dealer and the Madrigal Technical Services Department locate and repair the difficulty as quickly as possible.

43

A copy of the original bill of sale will serve to verify warranty status. Please include it with the unit when it is brought in for warranty service.



Warning!

All returned units must be properly packaged (preferably in their original packing material), and the proper return authorization numbers must be marked on the outer carton for identification. If the packaging to protect the unit is, in our opinion or that of our dealer, inadequate to protect the unit, we reserve the right to repackage it for return shipment at the owner's expense. Neither Madrigal nor your dealer can be responsible for shipping damage due to improper (that is, non-original) packaging.

Your dealer can order a new set of shipping materials for you if you need to ship your component and no longer have the original materials. There will be a charge for this service. We *strongly* recommend saving all packing materials in case you need to ship your unit some day.

Specifications

The correlation between published specifications and sonic quality is unreliable. A list of numbers reveals virtually nothing. All technical measurements must be subject to qualitative as well as quantitative interpretation.

Measurements of the N°360S yield excellent results by any standards. However, only those specifications that apply to its actual operation are included here.

■ Frequency response:	10Hz - 20kHz +0dB, -0.2dB
■ Total harmonic distortion (THD):	0.001% @ 1 kHz, 0dB, A-weighted
■ Dynamic range:	98dB (or better)
■ Signal-to-noise ratio:	105dB
■ Channel separation:	Better than 110 dB
■ Intermodulation distortion (SMPTE IMD):	Less than 0.005%
■ Digital-to-analog conversion:	Dual differential 24-bit DACs
■ Digital filter:	8x oversampling, 24-bit throughput
■ Analog filter:	Bessel-tuned, linear phase to 40kHz
■ Low-level linearity:	Deviation unmeasurable to below -70dB, approximately +1.7dB below -90dB (undithered, referenced to 0dB @ 1kHz)
■ Output impedance:	Less than 6Ω
■ Mains voltage:	100V, 120V, 220V, 230V, 240V
■ Mains frequency:	50/60 Hz
■ Mains consumption:	50 watts
■ Overall dimensions:	See "Dimensions"
■ Shipping weight:	35 lbs. (16 kg)
■ Input complement, N°360S:	2 XLR-type female connectors 1 RCA-type female connectors 1 BNC-type female connectors 1 ST-type connector 1 EIAJ-type connectors 1 IEC mains connector (on bottom) 1 1/8" mini-jack connector for IR repeater 1 IEC AC mains receptacle 1 RJ-45 communications port (PHASTLink™)
■ Output complement, N°360S:	1 pair XLR-type male connectors (analog) 1 pair RCA-type female connectors (analog) 1 XLR-type male connector (digital) 1 RJ-45 communications port (PHASTLink™) 1 RJ-45 communications port (Mark Levinson Linking™ master)

Madrigal provides an owner-transferable, five year limited warranty on all Mark Levinson products within the U. S. and Canada ONLY. Warranty and service policies outside the U. S. and Canada are set by the local, authorized distributor and are applicable in the country of purchase ONLY. Madrigal products are designed to operate at set voltages appropriate for the country of sale and may be damaged if operated at the wrong voltage.

Dimensions

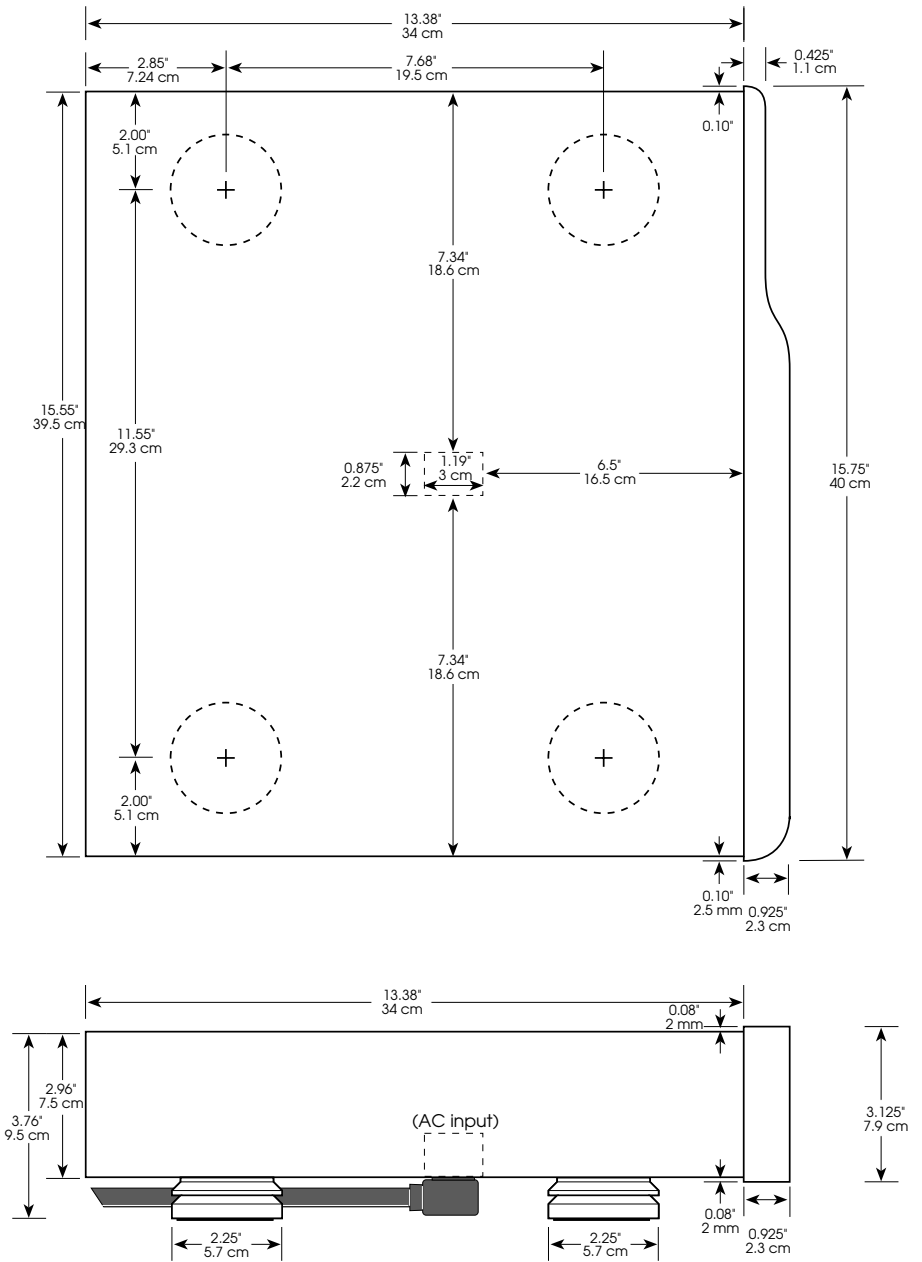



MADRIGAL

2081 South Main Street, P.O. Box 781
Middletown, Connecticut 06457 USA

Telephone: (860) 346-0896
Fax: (860) 346-1540
<http://www.madrigal.com>

mark
levinson[®]
MADRIGAL AUDIO LABORATORIES

is a registered trademark of Madrigal Audio Laboratories, Inc.
H a Harman International company