

Operating Manual

Mark Levinson®
N°26
Dual Monaural
Preamplifier

Madrigal Audio Laboratories, Inc.

WARNING: TO REDUCE THE RISK OF FIRE OR ELECTRIC SHOCK,
DO NOT EXPOSE THIS APPLIANCE TO RAIN OR MOISTURE.

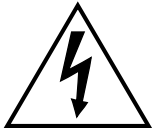
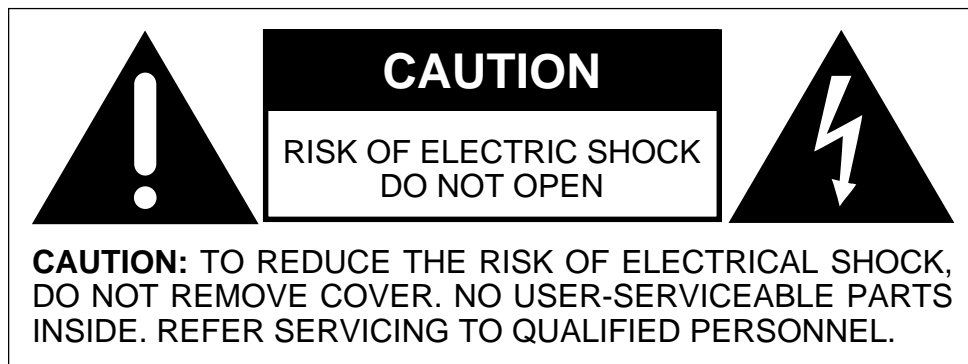

The lightning flash with arrowhead symbol, within an equilateral triangle, is intended to alert the user to the presence of uninsulated “dangerous voltage” within the product’s enclosure that may be of sufficient magnitude to constitute a risk of electric shock to persons.



The exclamation point within an equilateral triangle is intended to alert the user to the presence of important operating and maintenance (servicing) instructions in the literature accompanying the appliance.

Important safety instructions

Please read all instructions and precautions carefully and completely before operating your N°26 Dual Monaural Preamplifier.

1. **ALWAYS** disconnect your entire system from the AC mains before connecting or disconnecting any cables, or when cleaning any component.
2. This product is equipped with a three-conductor AC mains power cord which includes an earth ground connection. To prevent shock hazard, all three connections must **ALWAYS** be used. If your electrical outlets will not accept this type of plug, an adapter may be purchased. If an adapter is necessary, be sure it is an approved type and is used properly, supplying an earth ground. If you are not sure of the integrity of your home electrical system, contact a licensed electrician for assistance.
3. AC extension cords are not recommended for use with this product. If an extension cord must be used, be sure it is an approved type and has sufficient current-carrying capacity to power this product.
4. **NEVER** use flammable or combustible chemicals for cleaning audio components.
5. **NEVER** operate this product with any covers removed.
6. **NEVER** wet the inside of this product with any liquid.
7. **NEVER** pour or spill liquids directly onto this unit.
8. **NEVER** block air flow through ventilation slots or heatsinks.
9. **NEVER** bypass any fuse.
10. **NEVER** replace any fuse with a value or type other than those specified.
11. **NEVER** attempt to repair this product. If a problem occurs, contact your Mark Levinson® retailer.
12. **NEVER** expose this product to extremely high or low temperatures.
13. **NEVER** operate this product in an explosive atmosphere.
14. **ALWAYS** keep electrical equipment out of the reach of children.

From all of us at Madrigal Audio Laboratories, thank you for choosing the Mark Levinson® N° 26 Dual Monaural Preamplifier.

A great deal of effort went into the design and construction of this precision device. Used properly, it will give you many years of enjoyment.

Table of contents

Front panel	1
Rear panel	3
Unpacking and placement	5
Unpacking	5
Placement	5
Ventilation	5
Voltage selection	6
<i>PLS-226 bottom-panel label</i>	6
Set-up and installation	7
Connectors and cables	7
Internal adjustments: line gain	7
<i>Line gain settings</i>	7
Internal adjustments: phono gain	7
<i>Phono gain settings (high-gain option)</i>	7
<i>Phono gain settings (low-gain option)</i>	7
Internal adjustments: cartridge loading	8
<i>Cartridge loading settings (high-gain option)</i>	8
<i>Cartridge loading settings (low-gain option)</i>	8
Internal adjustments: optional load terminals	8
<i>Terminating the optional load</i>	8
Internal adjustments: varying the input capacitance	9
Internal adjustments: adjusting the balanced input gain	9
<i>Balanced input gain settings</i>	9
Making the internal adjustments	9
<i>N°26, internal adjustments</i>	9
Power connection and system activation	10
<i>AC power cord polarity</i>	10
Turning off the N°26	10
Care and maintenance	11
Specifications	12
Phono section	12
Line section	12
Dimensions	13
<i>Dimensions, N°26, top view</i>	13
<i>Dimensions, N°26, side view</i>	13
<i>Dimensions, PLS-226, side view</i>	14
<i>Dimensions, PLS-226, top view</i>	14

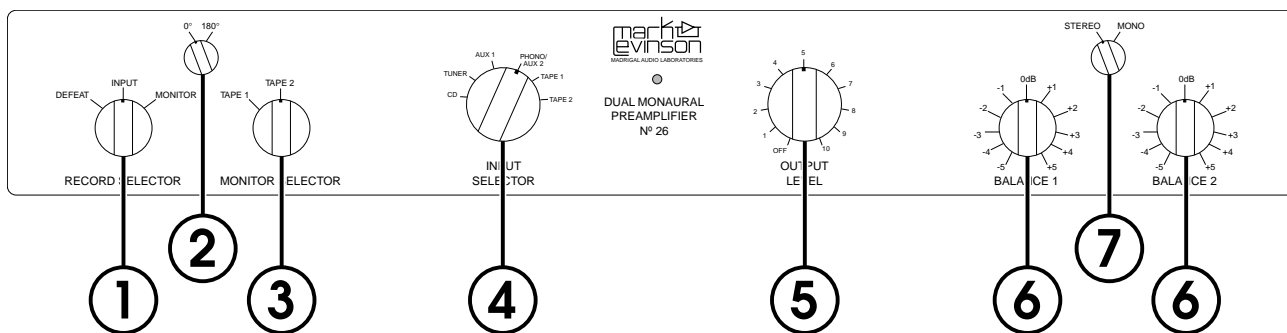

Front panel

1 RECORD SELECTOR

Selects between the program source (selected via the **INPUT SELECTOR**), and either of two tape monitor inputs (selected via the **MONITOR SELECTOR**).

In the **DEFEAT** position, the tape outputs are disconnected.

In the **INPUT** position, the tape outputs are connected while still monitoring the selected source.

In the **MONITOR** position, the selected tape machine can be monitored without affecting the signal at the tape outputs.

Note: Because of the switching arrangement employed in the N°26, we recommend that while making a critical recording you don't operate the **RECORD SELECTOR** switch.

If you wish to monitor the signal from tape, set the **RECORD SELECTOR** to **MONITOR** and use your tape machine's monitor switch to switch between input and tape.

2 0°/180°

In the **0°** position, the signal at the main outputs is in phase with the input signal. In the **180°** position, the output signal is inverted 180 degrees. This allows you to optimize your system's sonic performance based on recording/mastering processes used for a specific program.

The **0°/180°** switch doesn't affect the tape outputs.

3 MONITOR SELECTOR

When the **RECORD SELECTOR** is in the **MONITOR** position, this selects between the **TAPE 1** and **TAPE 2** inputs.

4 INPUT SELECTOR

Selects one of the six inputs: **CD**, **TUNER**, **AUX 1**, **PHONO/AUX 2** (depending on the installed option), **TAPE 1**, or **TAPE 2**.

5 OUTPUT LEVEL

Adjusts volume at the main outputs.

The **OUTPUT LEVEL** control doesn't affect the tape outputs.

Note: In some systems, particularly those with high-efficiency loudspeakers, high-gain amplifiers, and balanced interconnections, it's possible that you may hear some low-level sound through your loudspeakers **even with the N°26's OUTPUT LEVEL control set to OFF.**

If this occurs with all inputs, reduce the **line gain** (via the internal switches). If this occurs only when listening to the source connected to the N°26's optional balanced input, reduce the **balanced input gain** (via the internal switches). See "Set-up and installation."

6 BALANCE 1, BALANCE 2

Adjusts volume at the main outputs.

The **BALANCE** controls don't affect the tape outputs.

7 STEREO/MONO

Selects between monaural or stereo mode at the main output.

The **STEREO/MONO** switch doesn't affect the tape outputs.

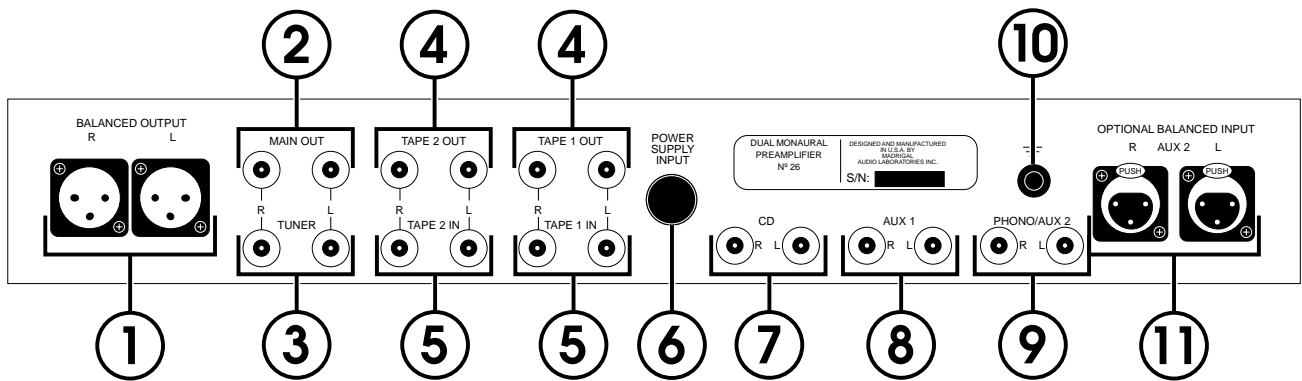

Rear panel

PRECAUTION

Disconnect all associated equipment from the AC mains **BEFORE** making any signal connections and applying power to the N°26/PLS-226.

1 BALANCED OUTPUT

If your power amplifier is equipped with balanced input connectors, it's best to connect it to the N°26 via these connectors, particularly if long cable lengths are required.

Connect the right-channel and left-channel **BALANCED OUTPUT** of the N°26 to the appropriate balanced inputs of the power amplifier.

The pin assignments of these XLR-type male outputs are:

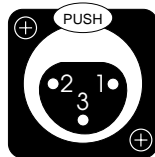

- Pin 1: Signal ground
- Pin 2: Signal + (non-inverting)
- Pin 3: Signal - (inverting)
- Connector ground lug: chassis ground

Refer to your power amplifier's operating manual to verify that the pin assignments of its input connector correspond to the N°26. If not, wire the cable so that the appropriate output pin connects to the equivalent input pin.

2 MAIN OUT

Connect these outputs to the right-channel and left-channel inputs of your power amplifier or electronic crossover.

These outputs are affected by the **OUTPUT LEVEL** control on the front panel of the N°26.

3 TUNER

Accepts right-channel and left-channel signal leads from a tuner or other line-level source equipment.

4 TAPE 1 OUT, TAPE 2 OUT

Connect these outputs to the right-channel and left-channel tape inputs of your tape machine.

5 TAPE 1 IN, TAPE 2 IN

Accept right-channel and left-channel signal leads from the tape-output connectors of a tape machine. These inputs can also be used with other line-level source equipment.

These outputs are unaffected by the **OUTPUT LEVEL** control on the front panel of the N°26.

6 POWER SUPPLY INPUT

Accepts one end of the DC cable that connects the N°26 to the PLS-226.

7 CD

Accepts right-channel and left-channel balanced signal leads from a CD player or other line-level source equipment.

8 AUX 1

Accepts right-channel and left-channel signal leads from line-level source equipment.

9 PHONO/AUX 2

If your N°26 is equipped with the phono option, connect your turntable's right-channel and left-channel signal leads to these inputs.

If your N°26 isn't equipped with a phono option, these inputs will accept signal leads from any line-level source equipment.

10 Ground binding post

Connect your tonearm's ground lead to this binding post.

11 OPTIONAL BALANCED INPUT

If your N°26 is equipped with the balanced input option, connect the right-channel and left-channel balanced line-level signal leads from source equipment with balanced output.

The pin assignments of these XLR-type female input connectors are:

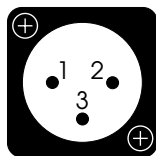

Pin 1: Signal ground
Pin 2: Signal + (non-inverting)
Pin 3: Signal - (inverting)
Connector ground lug: chassis ground

Refer to the operating manual of your balanced-output line-level source to verify that the pin assignments of its output connector correspond to the N°26. If not, wire the cable so that the appropriate output pin connects to the equivalent input pin.

Unpacking and placement

Unpacking Unpack your N°26 Preamplifier and PLS-226 Power Supply, and keep all packing materials for future transport. Remove all accessories from the cartons.

Carefully inspect the product for damage and flaws. If you find any, see your Mark Levinson dealer immediately.

Placement Place the N°26 as close as possible to the source equipment, thus keeping interconnect cabling as short as possible. It may be placed on a shelf or in a cabinet where it's convenient to operate.

A one-meter DC cable is provided to connect the PLS-226 to the N°26. This allows you to place the PLS-226 so that it won't induce hum in the N°26 and other sensitive components. If you're placing the N°26 and PLS-226 adjacent to each other, place the PLS-226 to the right of the N°26 (viewed from the front). You should also place associated equipment so that it doesn't induce hum in the N°26 and other sensitive components.

Ventilation Be sure to allow 3 to 4 inches of clearance above both the N°26 and the PLS-226, to allow heat dissipation through air circulation.

Drawings are included in this manual to facilitate special installations and custom cabinetry (see "Dimensions").

PRECAUTION

For your protection, review "Important safety instructions" before you install your N°26.

Voltage selection

The PLS-226 is factory-set (internally) for 100V, 120V, 200V, 220V, or 240V AC mains operation @ 50 or 60Hz. Make sure that the label on the bottom of the PLS-226 indicates the correct AC operating voltage for your location.

PLS-226 bottom-panel label

Voltage indication

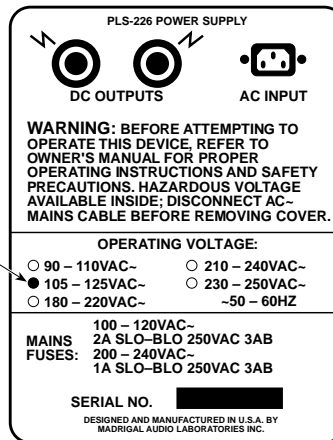

If the voltage indicated is incorrect, see your Mark Levinson dealer.

If you wish to change the AC operating voltage of the N°26/PLS-226, see your Mark Levinson dealer.

The N°26/PLS-226 can be powered by a normal 15-ampere AC mains line. If other devices are also powered from the same AC line, their additional power consumption must be taken into account.

Set-up and installation

Connectors and cables

The N°26 incorporates RCA-type and XLR-type connectors for audio signal input and output.

The Madrigal-designed RCA-type connectors used for single-ended audio interconnection are a great improvement over ordinary RCA-type connectors. The gold-plated XLR-type connectors employed are of European design, and are made to professional standards.

When connecting the N°26 to source equipment and power amplifiers, we recommend Madrigal Audio Laboratories HPC Interconnect Cable. HPC is available in various lengths, terminated with RCA, XLR, and Camac connectors. See your Mark Levinson dealer for more information.

Internal adjustments: line gain

The N°26 offers internal gain adjustment of the line amplifiers, in 6dB steps via two four-pole miniature rocker switches (one for each channel). These switches have been factory-adjusted at the lowest gain position (6dB of line gain in single-ended operation, and 12dB of line gain in balanced operation). In practice, you should have enough gain so that normal listening is possible with the **OUTPUT LEVEL** set at approximately **6**.

If you wish to increase the line gain, see "Making the internal adjustments;" refer to the table below for the proper switch positions for each gain setting.

Line gain settings

Switch				Gain	
#1	#2	#3	#4	Single-Ended Output	Balanced Output
On	On	Off	Off	18dB	24dB
Off	On	On	Off	12dB	18dB
Off	Off	On	On	6 dB	12dB

Internal adjustments: phono gain

The N°26 is available with either a high-gain or low-gain phono option. Each option offers two internally adjustable gain settings via two two-pole miniature rocker switches, one for each channel. The high-gain and low-gain phono options have been factory-adjusted at the lowest gain settings (58dB and 38dB, respectively).

If you wish to increase the gain, see "Making the internal adjustments;" refer to the tables below for the proper switch positions for each gain settings.

Phono gain settings (high-gain option)

Switch			Nominal Cartridge Output (3.54 cm/sec)
#1	#2	Gain	
On	Off	58dB	.2mV - .6mV
Off	On	64dB	.2mV and Lower

Phono gain settings (low-gain option)

Switch			Nominal Cartridge Output (3.54 cm/sec)
#1	#2	Gain	
On	Off	38dB	Greater than 2.0mV
Off	On	44dB	2.0mV and Lower

**Internal adjustments:
cartridge loading**

The high-gain and low-gain phono options offer internally selectable cartridge loading via two four-pole miniature rocker switches, one for each channel. The high-gain and low-gain options have been factory-adjusted at 825Ω and 47KΩ, respectively.

If you wish to change the factory-adjusted cartridge loading, see "Making the internal adjustments;" refer to the table below for the proper switch positions for each load setting.

*Cartridge loading settings
(high-gain option)*

Switch	10KΩ	825Ω	100Ω	30Ω	Optional
#1	Off	On	Off	Off	Off
#2	Off	Off	On	Off	Off
#3	Off	Off	Off	On	Off
#4	Off	Off	Off	Off	On

*Cartridge loading settings
(low-gain option)*

Switch	47KΩ	22KΩ	10KΩ	825Ω	Optional
#1	Off	On	Off	Off	Off
#2	Off	Off	On	Off	Off
#3	Off	Off	Off	On	Off
#4	Off	Off	Off	Off	On

**Internal adjustments:
optional load terminals**

Resistance values other than those listed above can be accommodated via the optional load terminals. Load resistors can be inserted into these terminals, allowing virtually any load desired.

*Terminating the
optional load*

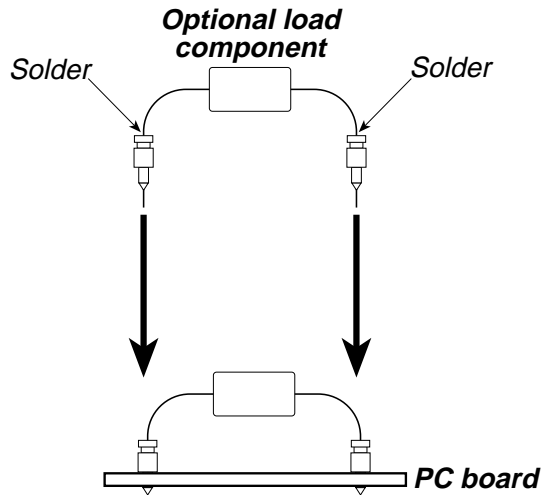

See "Making the internal adjustments;" refer to the "Cartridge loading settings" tables for the proper switch positions for the optional load.

Because the inherent input resistance (all switches off) is in parallel with the optional load terminals, use this formula to calculate the actual resistor needed:

$$R = 1 / (1/RD - X)$$

RD = Desired resistance in ohms

X = 0.00002 for Low-gain Phono Option,
0.0001 for High-gain Phono Option

Note: We recommend precision metal-film resistors; see your Mark Levinson dealer.

**Internal adjustments:
varying the input
capacitance**

If you wish to vary the input capacitance of the phono option to obtain the optimal value for a particular cartridge, a capacitor may also be inserted into the optional load terminals (see "Terminating the optional load" and "Making the internal adjustments").

Because the inherent input capacitance (all switches off) is in parallel with the optional load terminals, use the following formula to calculate the actual capacitor needed.

$$C = C_R - C_T - C_P$$

C = The capacitor value

C_R = Recommended capacitance value

C_T = Tonearm capacitance including leads

C_P = Preamplifier inherent shunt capacitance

(Low-gain phono option = 100pf; high-gain phono option = 1000pf)

Note: We recommend high-quality polypropylene, polystyrene or Teflon capacitors; see your Mark Levinson dealer.

**Internal adjustments:
adjusting the
balanced input gain**

The N°26's optional balanced input module allows you to adjust the input gain. If you wish to adjust the balanced input gain, see "Making the internal adjustments;" refer to the table below for the proper switch positions for each gain setting.

*Balanced input
gain settings*

Switch	-1.1dB	-7.1dB
#1	Off	On
#2	On	Off
#3	Off	On
#4	On	Off

**Making the
internal adjustments**

1. Make sure all associated equipment is disconnected from the AC mains, and that the PLS-226 is disconnected from the AC mains.

N°26, internal adjustments

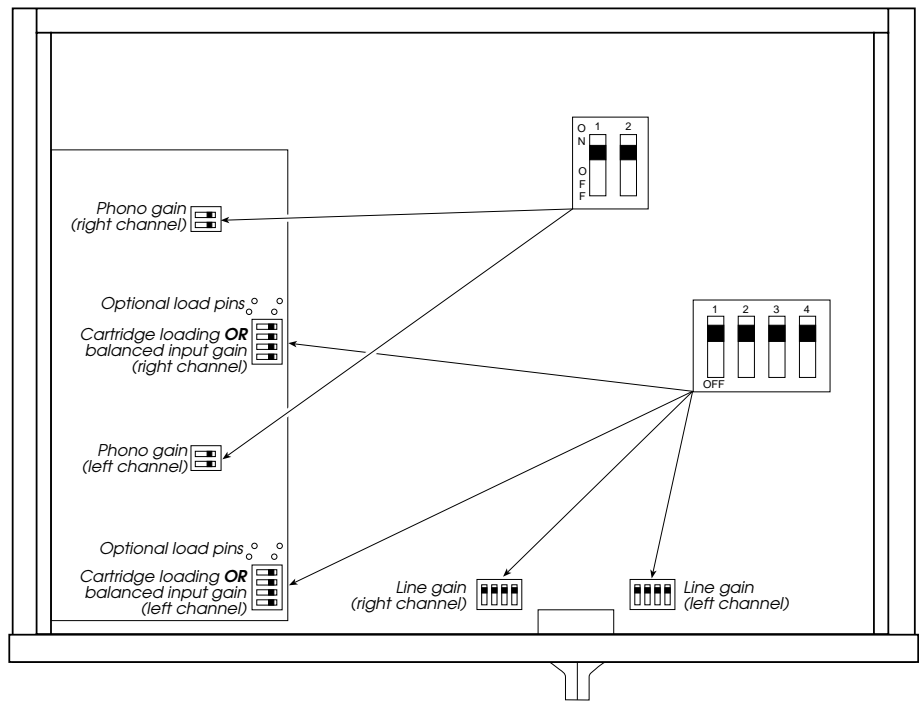

2. Using a 3/32" Allen key, remove the four 4-40 socket-head cap screws securing the end caps on the rear of the N°26's chassis.
3. Using a Phillips screwdriver, remove the four 4-40 screws securing the N°26's top plate. Carefully slide the top plate to the rear and remove it.
4. Adjust the gain switches (using a ballpoint pen or similar instrument) and install optional loads as desired.
5. Reassemble the N°26.

Power connection and system activation

Be sure all associated equipment is disconnected from the AC mains.

After making all signal connections and internal adjustments, connect the DC cable to either of the DC connectors on the rear panel of the PLS-226.

Connect the other end of the DC cable to the **POWER SUPPLY INPUT** connector on the rear panel of the N°26.

Connect the AC cord to the male IEC connector on the rear panel of the PLS-226, then connect the AC cord to the AC mains.

AC power cord polarity

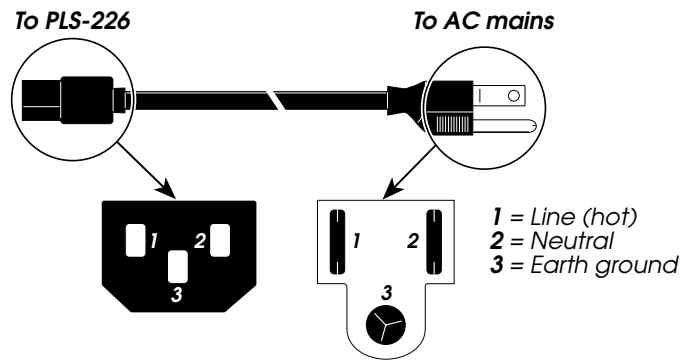

The LEDs on the PLS-226 and N°26 will light. Allow the N°26's circuitry to stabilize for 1 to 2 minutes, then connect all associated equipment to the AC mains and activate it.

Turning off the N°26

For optimal sonic performance and longevity, the N°26/PLS-226 is designed to remain powered at all times (a power-on/power-off switch isn't provided).

***Before** connecting or disconnecting the PLS-226 from the AC mains, be sure that the N°26's **OUTPUT LEVEL** is set to **OFF** (the lowest position), and that your power amplifiers are turned off.*

Care and maintenance

To remove dust from the cabinet of the N°26, use a feather duster. To remove dirt and fingerprints, we recommend isopropyl alcohol and a soft cloth.

Specifications

The correlation between published specifications and sonic quality is unreliable. A list of numbers reveals virtually nothing. All technical measurements must be subject to qualitative as well as quantitative interpretation.

Measurements of the N°26 yield excellent results by any standards. However, only those specifications that apply to its actual operation are included here.

-
- **Power consumption:** 50W maximum, depending on options
 - **Mains voltage:** 100V, 120V, 200V, 220V, or 240VAC @ 50/60Hz
 - **Overall dimensions:** See "Dimensions"
 - **Shipping weight (2 boxes):** 30 lbs. (13.6kg)
 - **Connector complement:**
 - 18 female RCA-type connectors
 - 2 XLR-type female connectors
 - 2 XLR-type male connectors
 - 1 binding post (turntable ground)
 - 3 nine-pin connectors
 - 1 IEC mains connector
- Phono section**
- **Gain:** Selectable (see "Set-up and installation")
 - **Moving-magnet phono option:** 38dB, 44dB
 - **Moving-coil phono option:** 58dB, 64dB
 - **Input impedance:** Selectable (see "Set-up and installation")
 - **Output impedance:** 10Ω
 - **Maximum output (TAPE output):** 6V
 - **Recommended load (TAPE outputs):** 10KΩ or greater
- Line section**
- **Gain:** Selectable (see "Set-up and installation")
 - **Single-ended:** 6dB, 12dB, 18dB
 - **Balanced:** 12dB, 18dB, 24dB
 - **Input impedance:** 14KΩ shunted by 220pf
 - **Maximum output (MAIN outputs):** 6V
 - **Recommended load (TAPE outputs):** 600Ω or greater

For more information, see your Mark Levinson dealer, or contact:

Madrigal Audio Laboratories, Inc.

2081 South Main Street (Route 17), P.O. Box 781
Middletown, Connecticut 06457 USA

Telephone (203) 346-0896
(FAX (203) 346-1540

If purchased in North America, this Mark Levinson product's warranty is owner-transferable. Warranty conditions are valid only in the country where the product was originally purchased.

For warranty information and conditions on products purchased outside of North America, contact your local dealer or regional distributor.

Dimensions

Dimensions, N°26, top view

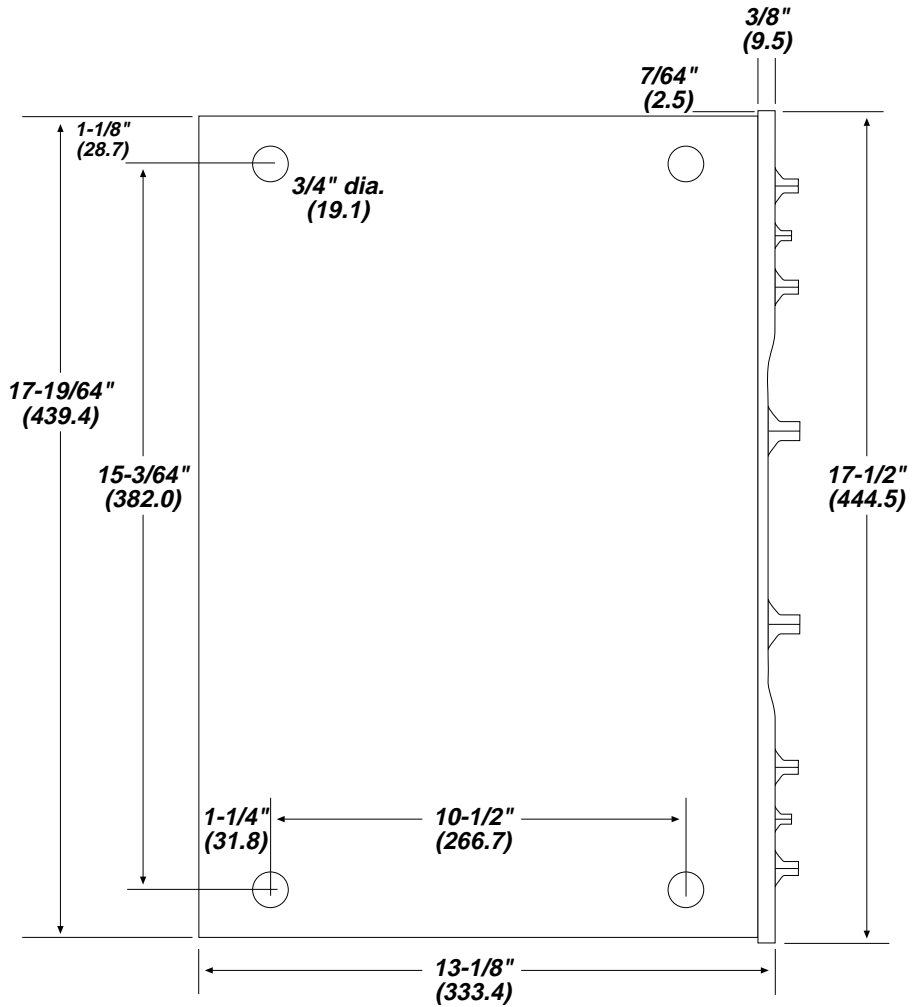

Dimensions, N°26, side view

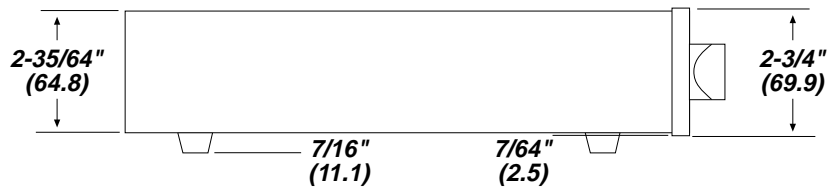

Dimensions, PLS-226,
top view

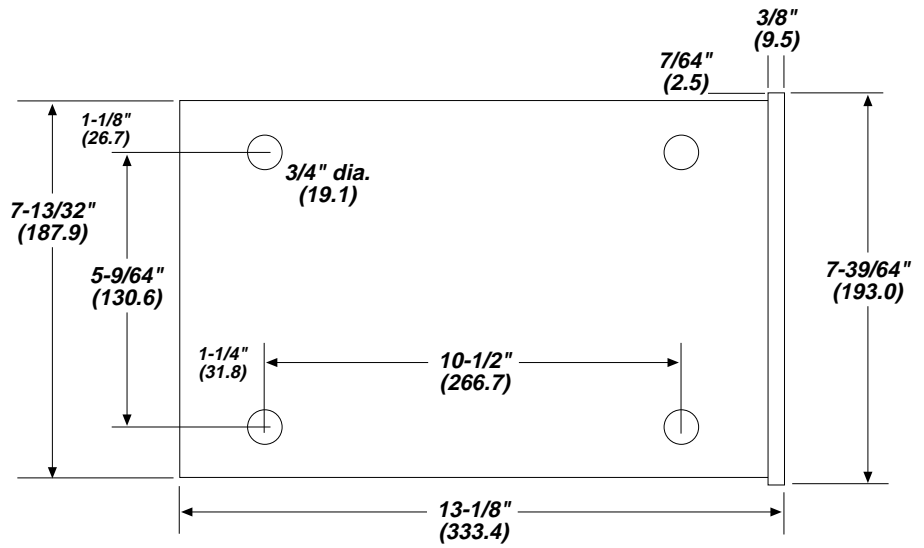

Dimensions, PLS-226,
side view

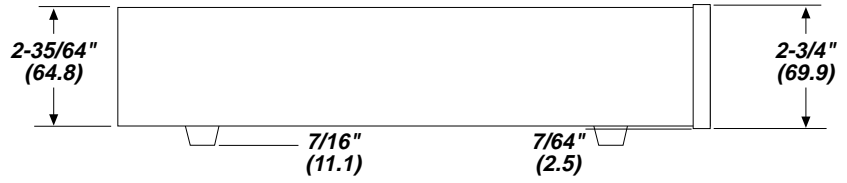

MADRIGAL

MADRIGAL AUDIO LABORATORIES

2081 South Main Street, P.O. Box 781
Middletown, Connecticut 06457 USA

Telephone: (203) 346-0896
Fax: (203) 346-1540



is a registered trademark of Madrigal Audio Laboratories, Inc.