

EGOTERIC

P-03

Super Audio CD Transport
Owner's Manual





CAUTION
RISK OF ELECTRIC SHOCK
DO NOT OPEN



CAUTION: TO REDUCE THE RISK OF ELECTRIC SHOCK, DO NOT REMOVE COVER (OR BACK). NO USER-SERVICEABLE PARTS INSIDE. REFER SERVICING TO QUALIFIED SERVICE PERSONNEL.



The lightning flash with arrowhead symbol, within an equilateral triangle, is intended to alert the user to the presence of uninsulated "dangerous voltage" within the product's enclosure that may be of sufficient magnitude to constitute a risk of electric shock to persons.



The exclamation point within an equilateral triangle is intended to alert the user to the presence of important operating and maintenance (servicing) instructions in the literature accompanying the appliance.

IMPORTANT SAFETY INSTRUCTIONS

- 1) Read these instructions.
 - 2) Keep these instructions.
 - 3) Heed all warnings.
 - 4) Follow all instructions.
 - 5) Do not use this apparatus near water.
 - 6) Clean only with dry cloth.
 - 7) Do not block any ventilation openings. Install in accordance with the manufacturer's instructions.
 - 8) Do not install near any heat sources such as radiators, heat registers, stoves, or other apparatus (including amplifiers) that produce heat.
 - 9) Do not defeat the safety purpose of the polarized or grounding-type plug. A polarized plug has two blades with one wider than the other. A grounding type plug has two blades and a third grounding prong. The wide blade or the third prong are provided for your safety. If the provided plug does not fit into your outlet, consult an electrician for replacement of the obsolete outlet.
 - 10) Protect the power cord from being walked on or pinched particularly at plugs, convenience receptacles, and the point where they exit from the apparatus.
 - 11) Only use attachments/accessories specified by the manufacturer.
 - 12) Use only with the cart, stand, tripod, bracket, or table specified by the manufacturer, or sold with the apparatus. When a cart is used, use caution when moving the cart/apparatus combination to avoid injury from tip-over.
-
- 13) Unplug this apparatus during lightning storms or when unused for long periods of time.
 - 14) Refer all servicing to qualified service personnel. Servicing is required when the apparatus has been damaged in any way, such as power-supply cord or plug is damaged, liquid has been spilled or objects have fallen into the apparatus, the apparatus has been exposed to rain or moisture, does not operate normally, or has been dropped.
 - Do not expose this apparatus to drips or splashes.
 - Do not place any objects filled with liquids, such as vases, on the apparatus.
 - Do not install this apparatus in a confined space such as a book case or similar unit.
 - The apparatus draws nominal non-operating power from the AC outlet with its POWER switch in the off position.
 - The apparatus should be located close enough to the AC outlet so that you can easily grasp the power cord plug at any time.
 - An apparatus with Class I construction shall be connected to an AC outlet with a protective grounding connection.

WARNING: TO PREVENT FIRE OR SHOCK HAZARD, DO NOT EXPOSE THIS APPLIANCE TO RAIN OR MOISTURE.

CAUTION

- DO NOT REMOVE THE EXTERNAL CASES OR CABINETS TO EXPOSE THE ELECTRONICS. NO USER SERVICEABLE PARTS ARE WITHIN!
- IF YOU ARE EXPERIENCING PROBLEMS WITH THIS PRODUCT, CONTACT TEAC FOR A SERVICE REFERRAL. DO NOT USE THE PRODUCT UNTIL IT HAS BEEN REPAIRED.
- USE OF CONTROLS OR ADJUSTMENTS OR PERFORMANCE OF PROCEDURES OTHER THAN THOSE SPECIFIED HEREIN MAY RESULT IN HAZARDOUS RADIATION EXPOSURE.

For U.S.A.

This equipment has been tested and found to comply with the limits for a Class B digital device, pursuant to Part 15 of the FCC Rules. These limits are designed to provide reasonable protection against harmful interference in a residential installation. This equipment generates, uses, and can radiate radio frequency energy and, if not installed and used in accordance with the instructions, may cause harmful interference to radio communications. However, there is no guarantee that interference will not occur in a particular installation. If this equipment does cause harmful interference to radio or television reception, which can be determined by turning the equipment off and on, the user is encouraged to try to correct the interference by one or more of the following measures:

- Reorient or relocate the equipment and/or the receiving antenna.
- Increase the separation between the equipment and receiver.
- Connect the equipment into an outlet on a circuit different from that to which the receiver is connected.
- Consult the dealer or an experienced radio/TV technician for help.

CAUTION

Changes or modifications to this equipments not expressly approved by TEAC CORPORATION for compliance will void the user's warranty.

This product has been designed and manufactured according to FDA regulations "title 21, CFR, chapter 1, subchapter J, based on the Radiation Control for Health and Safety Act of 1968", and is classified as class 1 laser product. There is not hazardous invisible laser radiation during operation because invisible laser radiation emitted inside of this product is completely confined in the protective housings.

The label required in this regulation is shown ①.

① For U.S.A.

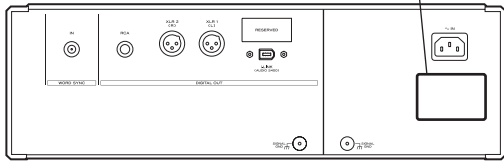
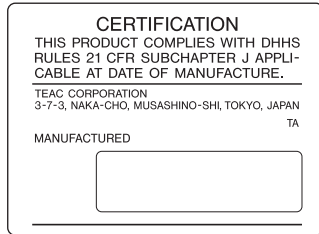

Optical pickup :

Type : GH20707A2A
 Manufacturer : SHARP CORPORATION
 Laser output : Less than 1mW on the objective lens
 Wavelength : 788±5 nm (CD)

VARING: APPARATEN INNEHÅLLER LASER KOMPONENT MED STRÅLNING ÖVERSTIGANDE KLASS 1.

“ADVARSEL: USYNLIG LASERSTRÅLING VED ÅBNING NAR SIKKERHEDSAFBRYDERE ER UDE AF FUNKTION. UNDGÅ UDSÆTTELSE FOR STRÅLING”

“VAROITUS! SUOJAKOTELOA EI SAA AVATA. LAITE SISÄLTÄÄ LASERDIODIN. JOKA LÄHETTÄ (NÄKYMÄTÖNTÄ) SILMILLE VAARALLISTA LASERSÄTEILYÄ”.

ADVARSEL: USYNLIG LASERBESTRÅLING NÅR DENNE DELEN ER ÅPEN OG SIKKERHETSSPERREN ER UTKOBLET UNNGÅ UTSETTELSE FOR STRÅLING.

Contents

Thank you for choosing Esoteric. Read this manual carefully to get the best performance from this unit.

- Features 4
- Before Use 6
- Discs 7
- Connections 8
- Connection examples (connecting three D-03) 10
- i.LINK (IEEE 1394) 11
- Front panel features 12
- Understanding the remote control unit 14
- Remote Control Unit. 15

- Using the P-03 for the first time 16
- Digital output and selecting priority playback area 17

- Playback 18
- Selecting a track 20
- 2ch/Multi ch 21
- Programmed playback 22
- Changing display mode 23
- Repeat mode 23
- Word sync 24
- Display dimming 24
- Up convert 25

- Settings (introduction). 26
 - Settings (Speaker). 28
 - Settings (Audio) 28

- Troubleshooting 30
- Specifications 31
- Block Diagram 32

The latest VRDS mechanism for Super Audio CD

(Specially developed ball bearings for the optimum VRDS mechanism.)

The VRDS mechanism securely clamps the disc to the turntable whose diameter is exactly the same as that of the disc. This system completely eliminates vibration inherent to removable media and unwanted vibrations generated by the mechanical systems. Also, this mechanism clamps the disc at a slight inclination so as to compensate for warping or deformation improving the accuracy of the optical axes of both the laser pickup and the pit surface of the disc. This is effective in reducing errors in reading the disc data as well as in preventing timing errors from erratic data acquisition timing.

To achieve the high-speed rotation with superior stability that is required of a Super Audio CD player, the P-03 is equipped with a duralumin turntable. A specially developed processing technology was used to enable high-precision forming of this lightweight material normally used in building aircraft.

In a joint development project with [NSK Ltd.](#), we developed proprietary, highly precise ball bearings for the VRDS mechanism. Rolling elements made from precisely machined ceramic balls provide ultra smooth rotation. The application of a pre-load to the ball bearing pair ensures a high rigidity and precise rotation not present in conventional bearings but necessary for handling the wide rotational range from normal CD to Super Audio CD playback.

A massive 20mm-thick, S5400 steel bridge supports the mechanism to control vibrations produced by turntable rotation.

Coreless motor employing neodymium magnet

Esoteric has developed a new, life-long three-phase brushless spindle motor for high-speed rotation of the large diameter turntable. Combined with the high-precision ball bearings that firmly hold the turntable in place, this motor helps to further minimize rotation irregularities and vibrations. The magnetic field of the neodymium magnet has been optimized through magnetic field analysis to minimize fluctuations in motor drive current and reduce the impact on audio circuits.

A pickup designed to prevent tilting of the laser optical axis and speed feedback-controlled sled transport

The pickup of the P-03 has a highly rigid sliding-shaft structure that prevents the lens from tilting and the laser optical axis is kept precisely aligned with the media's bit track. The sled moving mechanism uses a proprietary Hall element sensing-type, three-phase brushless motor while powerful electronic speed feedback circuits control this sled mechanism for quick access, thereby ensuring smooth, continuous movement with superior response.

Shutter isolates the mechanism from external influences

The tray opening and closing mechanism is equipped with a shutter for greater precision and to eliminate adverse effects from external sound pressure and vibrations on mechanical units. When closed, the shutter mechanism is mechanically secured to the front panel to prevent it from moving.

Power supply housed in separate chassis

The P-03 shares the dual block structure concept introduced in the P-01 where the power supply and the VRDS mechanism are housed in independent blocks.

The enclosure provides a high degree of isolation yet high capacity in a compact design.

The power supply consists of two transformers, one for the mechanism and the servo drive and the other for processing digital signals. The WB transformer for the mechanism and the servo drive ensures low current loss and quick response.

Highly rigid chassis completely eliminates internal and external vibrations preventing sound quality deterioration

The bottom plate of the chassis that supports the mechanisms is 5 mm thick and weighs 6 kg. Thick aluminum is used in the top, side, bottom and front panels. Esoteric-exclusive pinpoint feet (patent pending) made of quenched steel support the chassis. Every possible effort has been accorded to precision in the mounting of mechanical parts, the rigidity of the housing and eliminating sympathetic vibration. The thick, brushed-aluminum front, top, bottom and side panels contribute to a sense of quality and elegance found only in high-end Super Audio CD/CD units.

Upward conversion on CD playback

The upward conversion feature can output a maximum fs 176.4 kHz when playing back CDs. A high-precision crystal oscillator precise to ± 3 ppm (temperature characteristics included) minimizes jitter. During Super Audio CD playback, the DSD signal (1-bit, 64 fs) is output directly without further processing. A mode for converting the CD PCM signal to DSD has also been added. This gives the P-03 accurate control over signal differences for optimal expression of tonal texture required by each signal type. It is thus possible to select the audio format (PCM or DSD) that best suits the music genre played back or the amplifier and speaker combinations used to provide a musical experience that only Esoteric is capable of.

Digital audio output

The output terminals include two XLR jacks (in ES-LINK and Dual AES output modes, both jacks are used), one RCA jack and one i.LINK jack. The RCA jacks do not output sound from Super Audio CDs.

ES-LINK, an Esoteric-exclusive format for Super Audio CD digital output

Super Audio CD output is output in the Esoteric-exclusive ES-LINK format from the XLR jacks or the i.LINK (AUDIO) jacks. When a Super Audio CD is played back and XLR DUAL is selected, the output is automatically output in the ES-LINK format. Currently, only the D-03 and D-01 Esoteric D/A converters support ES-LINK.

WORD SYNC

The word sync feature allows this unit to synchronize with an external word clock. The input frequency can be switched between 44.1, 88.2, 176.4 and 100 kHz. The P-03 is designed so that the phase shift between the word clock and output sampling frequency is kept within 10 degrees when there is no discrepancy between the two.

High-quality wires for maximum performance

High purity 6N copper wires are used for most internal wiring that affect sound quality to improve purity and sound texture resolution. Polyolefin, a non-PVC material was used for the insulating sheath out of consideration for the environment as well as for sound quality. PVC is not used for wire insulation. The high purity 6N copper cable is developed with the help of Acro Japan Ltd. who also developed the highly acclaimed Esoteric MEXCEL interconnection cable and high-purity 8N copper cable.

Play Area button on front panel

The front panel now has a PLAY AREA button to enable selection of play area for hybrid Super Audio CDs also on the front panel.

What's in the box

Please confirm that the following accessories are in the box when you open it.

- Power cord x 1
- Screwdriver x 1
- Remote control unit x 1
- Batteries (AA, R6 or SUM-3) x 2
- Felt pad x 3
- Owner's manual x 1
- Warranty card x 1

Conventions about This Manual

- The types of functions and operations that can be used for a particular disc vary depending on the features built into that disc. In some cases, these functions and operations may differ from the descriptions given in this Owner's Manual.
- The drawings about the front panel display used in this Owner's Manual are purely for the purposes of explanation. The actual displays may differ slightly from what are shown here.

Read this before operation

- As the unit may become warm during operation, always leave sufficient space around the unit for ventilation.
- The voltage supplied to the unit should match the voltage as printed on the rear panel. If you are in any doubt regarding this matter, consult an electrician.
- Choose the installation location of your unit carefully. Avoid placing it in direct sunlight or close to a source of heat. Also avoid locations subject to vibrations and excessive dust, heat, cold or moisture.
- Do not place the unit on the amplifier/receiver.
- Do not open the cabinet as this might result in damage to the circuitry or electrical shock. If a foreign object should get into the unit, contact your dealer or service company.
- When removing the power plug from the wall outlet, always pull directly on the plug, never yank the cord.
- To keep the laser pickup clean, do not touch it, and always close the disc tray.
- Do not attempt to clean the unit with chemical solvents as this might damage the finish. Use a clean, dry cloth.
- Keep this manual in a safe place for future reference.

DO NOT MOVE THE UNIT DURING PLAYBACK

During playback, the disc rotates at high speed. Do NOT lift or move the unit during playback. Doing so may damage the disc or the unit.

WHEN MOVING THIS UNIT

When changing places of installation or packing the unit for moving, be sure to remove the disc and return the disc tray to its closed position in the player. Then, press the power switch to turn the power off, and disconnect the power cord. Moving this unit with the disc loaded may result in damage to this unit.

Placement of the unit

High-quality hardened tool steel is used for the pin-point feet attached to the bottom of the player. Although the outer feet may appear loose, the weight of the unit causes them to become firm and secure. The design effectively damps and reduces vibration.

- **WARNING:** Be careful to avoid injury when moving the unit. This unit weighs about 30 kg. Seek assistance when moving or placing this product.
- To protect the supporting furniture surface, you may stick the felt pads supplied with the unit to the bottom of the metal feet.

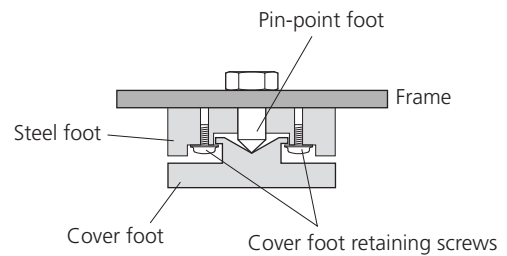

Beware of condensation

When the unit (or a disc) is moved from a cold to a warm place, or used after a sudden temperature change, there is a danger of condensation; vapor in the air could condense on the internal mechanism, making correct operation impossible. To prevent this, or if this occurs, leave the unit for one or two hours with the power turned on. Then the unit will stabilize at the temperature of its surroundings.

Maintenance

If the surface of the unit gets dirty, wipe with a soft cloth or use diluted neutral cleaning liquid. Be sure to remove any fluid completely. Do not use thinner, benzine or alcohol as they may damage the surface of the unit.

CAUTION

Ensure this product is not exposed to dripping or splashing and that no object filled with liquids, such as vases, is placed on the product.

Do not install this equipment in a confined space such as a book case or similar unit. Allow adequate air circulation around this product.



"Super Audio CD" is a registered trademark.

"DSD" is a registered trademark.

The i.LINK logo is a trademark of Sony Corporation, registered in the U.S. and other countries.

Type of discs that can be played on this system

This player can playback discs bearing any of the following logos:

	<p>Audio CD:</p> <ul style="list-style-type: none"> • 12cm or 8cm discs • Linear PCM digital audio <p>Audio CDs are divided into tracks.</p>
	<p>Super Audio CD:</p> <ul style="list-style-type: none"> • Single layer, dual layer or Hybrid layer • 12cm or 8cm discs • Digital audio (DSD) <p>Super Audio CDs are divided into tracks.</p>

About CD-R/CD-RW

CD-R/RW discs recorded in Audio CD format and finalized correctly are playable. But depending on the quality of the disc and/or the condition of the recording, some CD-R & CD-RW discs may not be playable.

Caution:

- If you record a disc using a personal computer, even if it is recorded in a compatible format, there are cases in which it may not play because of the settings of the application software used to create the disc. (Check with the software publisher for more detailed information.)
- Unfinalized CD-R/CD-RW discs cannot be played.

Following discs cannot be played with this unit:

- DVD, CD-G, Data part of CD-EXTRA, PHOTO CD, CD-ROM and DVD-ROM discs
- illegally produced discs
- scratched or damaged discs
- discs that are dusty, soiled or marked with fingerprints
- DualDisc

Warning:

If you attempt to play back such discs, there is a risk that sudden loud noise can blast over the speakers at full volume and cause damage to the speakers and your hearing.

Copy-protected discs and other discs that do not conform to the CD standard may not play back correctly in this player. If you use such discs in this unit, TEAC ESOTERIC COMPANY cannot be responsible for any consequences or guarantee the quality of reproduction. If you experience problems with such non-standard discs, you should contact the producers of the disc.

- Always place the disc on the disc tray with the label side up. (Compact discs can be played or recorded only on one side.)
- To remove a disc from its storage case, press down on the center of the case and lift the disc out, holding it carefully by the edges.



How to remove the disc



How to hold the disc

- Should the disc become dirty, wipe the surface radially (from the center hole outward towards the outer edge) with a soft, dry cloth:



- Never use such chemicals as record sprays, antistatic sprays or fluid, benzene or thinner to clean the discs. Such chemicals will do irreparable damage to the disc's plastic surface.
- Discs should be returned to their cases after use to avoid dust and scratches that could cause the laser pickup to "skip."
- Do not expose discs to direct sunlight or high humidity and temperature for extended periods. Long exposure to high temperatures will warp the disc.
- Do not play any disc that is warped, deformed or damaged. Playing such discs may cause irreparable harm to the playing mechanisms.
- CD-R and CD-RW discs are more sensitive to the effects of heat and ultraviolet rays than ordinary CDs. It is important that they are not stored in a location where direct sunlight will fall on them, and which is away from sources of heat such as radiators or heat-generating electrical devices.
- Printable CD-R and CD-RW discs aren't recommended, as the label side might be sticky and damage the unit.
- Do not stick papers or protective sheets on the discs and do not use any protective coating spray.
- Use a soft oil-based felt-tipped pen to write the information on the label side. Never use a ball-point or hard-tipped pen, as this may cause damage to the recorded side.
- Never use a stabilizer. Using commercially available CD stabilizers with this unit will damage the mechanisms and cause them to malfunction.
- Do not use irregular shape CDs (octagonal, heart shaped, business card size, etc.). CDs of this sort can damage the unit:

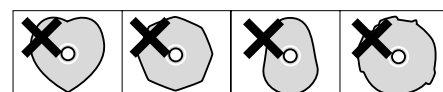

- If you are in any doubt as to the care and handling of a CD-R/CD-RW disc, read the precautions supplied with the disc, or contact the disc manufacturer directly.

Connections

CAUTION:

- Switch off the power to all equipment before making connections.
- Read the instructions of each component you intend to use with this unit.
- Be sure to insert each plug securely. To prevent hum and noise, avoid bundling the signal interconnection cables together with the AC power cord or speaker cables.

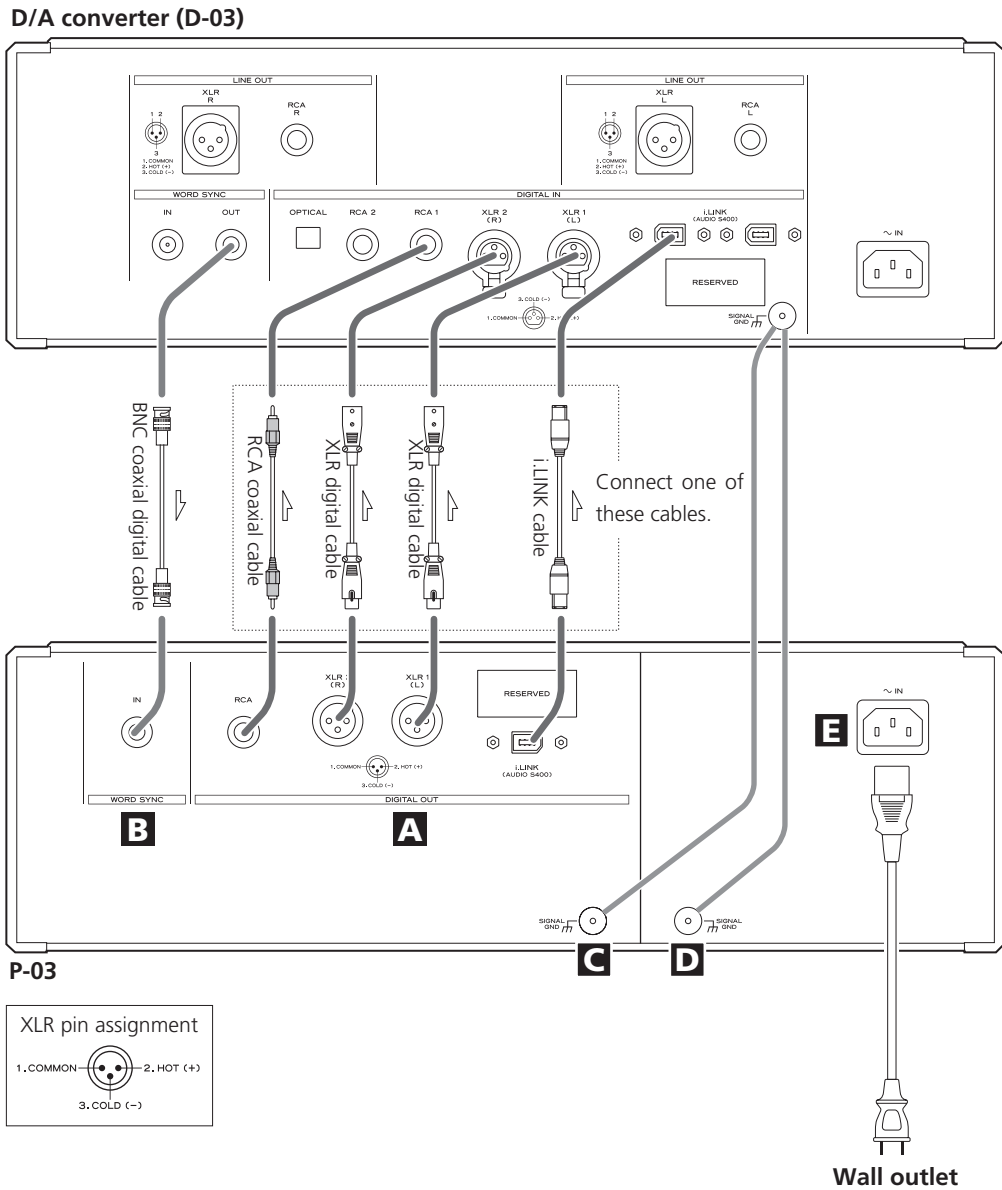

Digital signal output by each terminal

	Single XLR connection	Both XLR terminals connected to an ES-LINK device	i.LINK connection	RCA connection
Super Audio CD playback	No	Yes	Yes	No
Upconversion to CONV 44.1, 88.2, 176.4 during CD playback	Up to 176.4 kHz	Up to 176.4 kHz	(44.1 kHz*)	Up to 176.4 kHz
Upconversion to CONV DSD during CD playback	No	Yes	(44.1 kHz*)	No

*: Signals output by the i.LINK terminal do not go through the upconverter circuit and are not upconverted.

A Digital audio output terminals

These terminals output digital audio. Connect these terminals to the corresponding terminals on the D/A converter (D-03, etc.).

Use commercially available cables for the following connections.

- XLR: Use a balanced XLR digital audio cable
- RCA: Use an RCA coaxial digital cable
- i.LINK (Audio S400): Use S400 compatible 6-pin i.LINK cable (IEEE 1394 cable)

Select digital output depending on what terminals are connected (see pages 16-17).

Output of digital audio from a Super Audio CD requires a D/A converter compliant with Esoteric ES-LINK (D-03/D-01) or a D/A converter with an i.LINK (AUDIO) terminal.

- If your D/A converter supports ES-LINK or Dual AES, connect the XLR1 (L) terminal on this unit to the left XLR terminal of the D/A converter and the XLR2 (R) terminal on this unit to the right XLR terminal of the D/A converter.
- The i.LINK (AUDIO) terminal is a combined input and output cable interface.
- When using an i.LINK terminal, select i.LINK output setting (Stream Out) as required by connected devices (see pages 26-28).
- RESERVED indicates area allocated for future expansion of P-03 terminals.

B Word sync input terminal (WORD SYNC IN)

This terminal allows the use of an externally generated word clock connection using a commercially available BNC coaxial cable (75 ohm).

Connect the WORD SYNC OUT terminal on a D/A converter or word clock generator to this unit.

C Signal GND terminal

D Power supply GND terminal

Connecting the ground terminals on the D/A converter and amplifiers to ground may improve the sound quality.

- Note that this is not an electrical safety ground (earth).

E Power cord

Connect the power cord to the power cord receptacle and connect the power plug to a AC wall outlet when all other connections have been made.

- Although the power cord receptacle has a 3-pin plug, the ground pin is not connected to the chassis.
- Use only the supplied Esoteric power cord. Use of other power cords may result in fire or electric shock. Unplug the power cord when you are not going to use the unit for some time.

Connection examples (connecting three D-03)

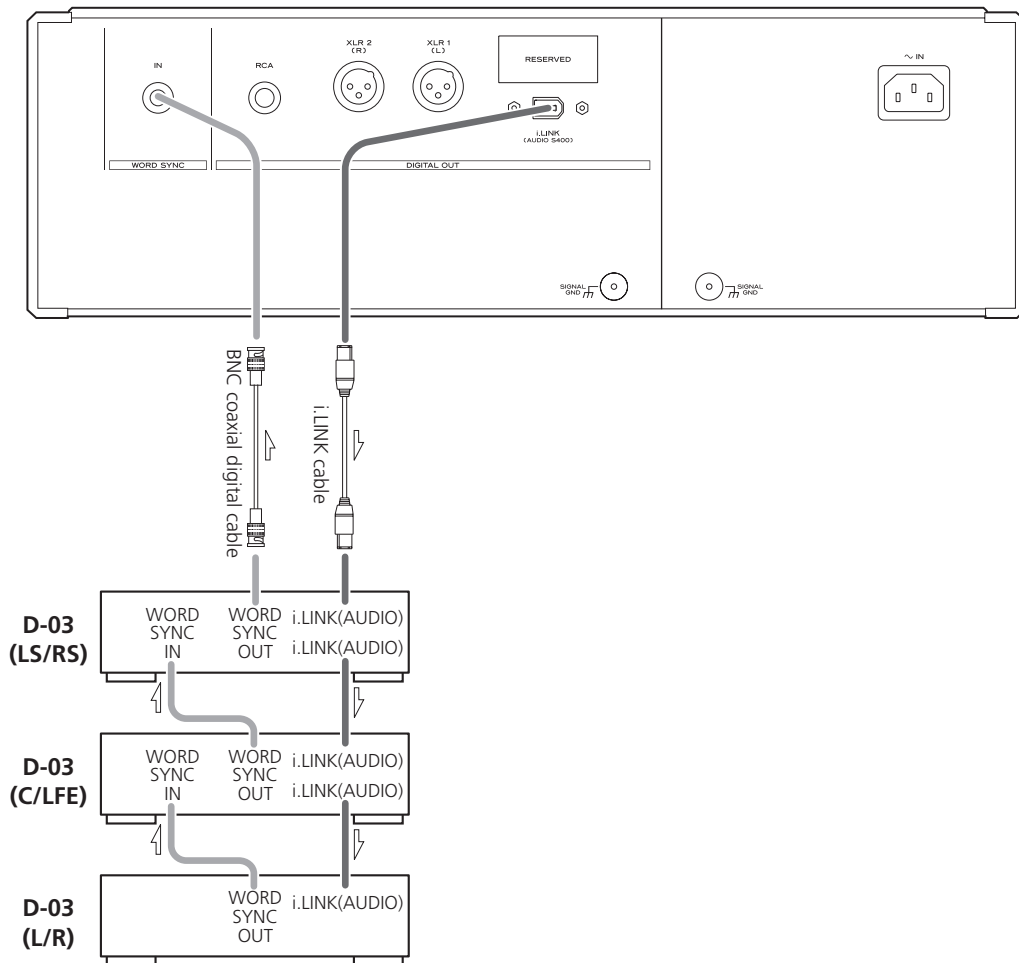

Three D-03 units are required to play multi-channel sound from a Super Audio CD without mixing it down to stereo.

First, connect the i.LINK (AUDIO) terminal on the P-03 to the D-03 i.LINK (AUDIO) terminal. Then connect the other i.LINK (AUDIO) terminal on the D-03 to the next D-03 unit. Daisy chain the three units similarly (in random order). Connect the word sync terminals as shown in the figure (in random order).

When connecting clock generator G-0/G-0s to the P-03, connect the WORD CLOCK OUT terminals to the WORD SYNC IN on the P-03.

Setting of the P-03

Digital Output setting	i.LINK (see pages 16-17)
WORD button	ON

Setting of the D-03

INPUT button	i.LINK
WORD button	One of the D-03 that outputs word synchronization signals: "OUT" The others: "IN" When the G-0 is connected, set all the D-03s to "IN".
W_OUT setting	176.4 or 88.2
CH_SEL setting	respective channels

Setting of the G-0/G-0s

Frequency change button (A, B or C)	176.4 kHz or 88.2 kHz
FREQUENCY MODE button	44.1kHz

The i.LINK is also known as IEEE 1394, an international specification.

This unit is ready for i.LINK (AUDIO).

By connecting an i.LINK (AUDIO)-capable device to the IEEE 1394 (or i.LINK (AUDIO) terminal on this unit using an i.LINK cable, you can transmit Super Audio CD multi-channel signals that could not be transmitted but in analog format in the past can be transmitted in its original digital format, in addition to the capability of transmitting 2-ch linear PCM data and multi-channel compressed audio signals.

If you have multiple i.LINK-capable devices, you can connect them through other devices to transmit data between them, so you don't need to be concerned with the order of connection.

Copyright protection system DTCP

To play back audio sounds recorded on Super Audio CD or DVD discs using i.LINK, both the player and the D/A converter need to be ready for the copyright protection system DTCP (Digital Transmission Content Protection).

This unit is ready for DTCP.

Data transfer rate

There are three transfer rates: 100 Mbps (S100), 200 Mbps (S200), and 400 Mbps (S400). This unit is capable of transferring data at a maximum 400Mbps.

For connection to an i.LINK-capable device, use a commercially available S400-compliant 6-pin i.LINK cable.

When connecting multiple i.LINK-capable devices, avoid connecting a device having slow transfer rate between devices having high transfer rate since this reduces the transfer rate of your whole system. Connect devices having high transfer rate towards the source as far upriver as possible.

NOTES

- Among the i.LINK formats there are "MPEG-2 TS" for BS digital source and "DV" for digital video for DVD recorders, as well as the "i.LINK (AUDIO)" (A&M Protocol). Never connect devices that are not ready for i.LINK (AUDIO) to this unit. If you do, this unit and others may get out of order or be damaged.
- In the process of data transfer, avoid plugging/unplugging the i.LINK cables in use or switch on/off the power.
- Among the i.LINK-capable devices there are some that, if not turned on, are not capable of relaying data.
- Chances are some i.LINK-capable devices will not respond to this unit's command.
- The receiving device may not support the output modes of this unit. Read through the instruction manual of devices you wish to connect before making connections.

How to connect multiple i.LINK-capable devices

Daisy chain connection

You can daisy-chain up to 17 devices including this unit.

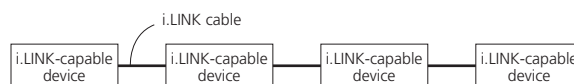

Connection in tree structure

If you are using a device having three or more i.LINK connectors, you may want to get the connection branched out. This way of connection allows you to connect up to 17 devices including this unit.

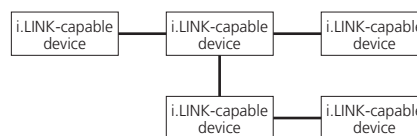

Your system does not work if data is fed back to the output device. Be careful not to create a loop.

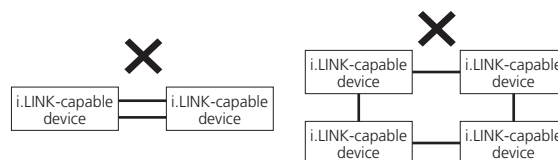

The i.LINK interface of this unit is designed in accordance with the following specifications:

- 1) IEEE Std 1394a-2000, Standard for a High Performance Serial Bus
- 2) Audio and Music Data Transmission Protocol 2.0

This unit is compliant with IEC 60958 bitstream, DVD-Audio, Super Audio CD in the AM824 sequence adaptation layers of this protocol.

Front panel features

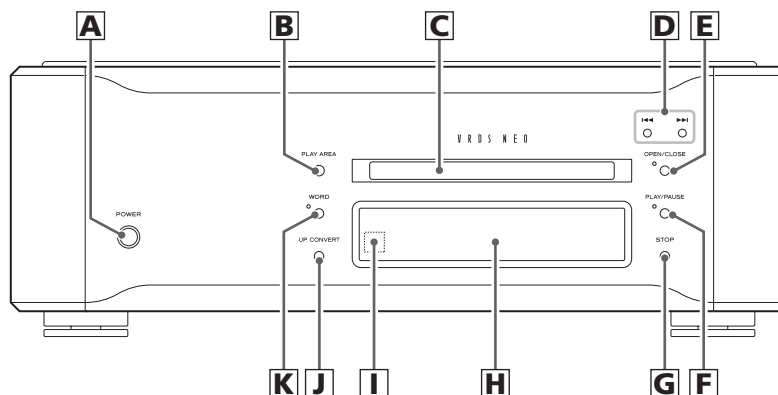

A POWER

Turn power on and off. The ring surrounding the button lights when the unit is on.

The equipment draws nominal non-operating power from the AC outlet with its POWER switch in the OFF position.

B PLAY AREA

When a hybrid Super Audio CD is loaded and the disc is not being played, press this button to change the play area of the disc.

Hold down this button for 2 seconds or more to engage digital output and the priority playback area setup mode.

C Disc tray and shutter

D SKIP (I<<</>>>I)

Use these buttons to skip forward or backward. Hold down the buttons 1 second or more to change scanning speed.

E OPEN/CLOSE

Press to open or close the disc tray.

The indicator flashes when the disc tray is being opened or closed and also when a disc is being read.

The indicator lights when there is a disc in the tray.

F PLAY

Press to play and press again to pause playback.

The indicator lights during playback and blinks when paused.

G STOP

Press to stop playback.

H Display

I Remote control sensor

Receives signals from the remote control unit. Point the remote control at this sensor when using the remote control.

J UP CONVERT

Use this button to convert the sampling frequency.

K WORD

Turn the word sync function on and off. When on, the unit will synchronize with an external word sync source.

Front panel features (Display)

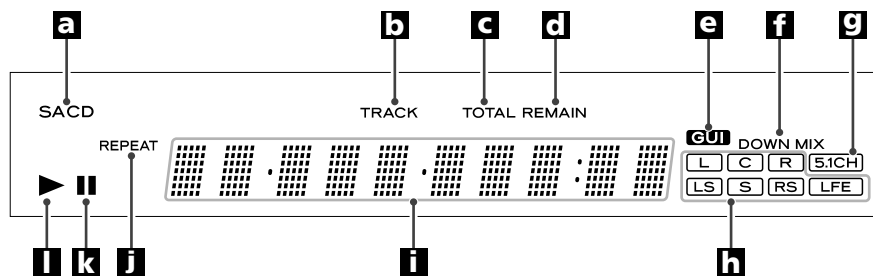

a Disc type indicator

Indicates the disc type of loaded disc (Super Audio CD or CD).

b TRACK indicator

Indicates that the track number of a disc is being shown.

c TOTAL indicator

Indicates that the total playback time is being shown.

d REMAIN indicator

Indicates that the remaining playback time is being shown.

e GUI indicator

Lights when the SETUP button is pressed and the setup mode is engaged.

f DOWN MIX indicator

Lights to show that a multi-channel source has been downmixed.

g 5.1 CH indicator

Lights to show that a "Multi ch" has been selected.

h Channel indicators

Light to show which surround channels are currently in use.

i Message area

Alphanumeric display that shows playback time, status messages, etc.

j REPEAT indicator

Lights when repeat play is selected.

k Pause indicator

Lights when playback is paused.

l Playback indicator

Lights during playback.

Understanding the remote control unit

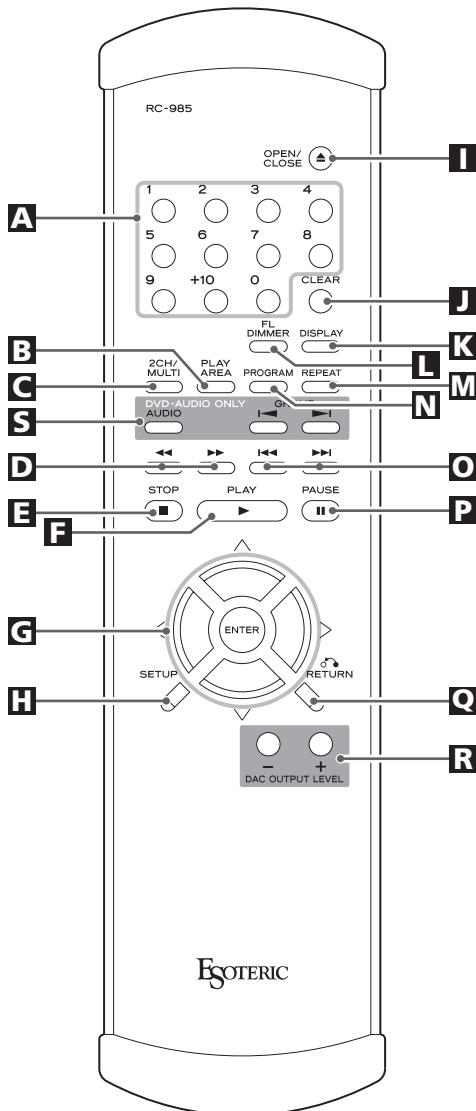

A Number buttons

Enter the track number.

B PLAY AREA

When a hybrid Super Audio CD is loaded and the disc is not being played, press this button to change the play area of the disc.

C 2CH/MULTI

Press to select 2-channel stereo or multi-channel surround audio output.

D SCAN

Press to scan forward and backward during playback.

E STOP (■)

Press to stop playback.

F PLAY (▶)

Press to start playback.

G Cursor buttons and ENTER

Use to navigate in the setup mode. Use the cursor buttons to select an item and press ENTER to confirm made selection.

H SETUP

Use to enter or exit the setup mode.

I OPEN/CLOSE (▲)

Press to open or close the disc tray.

J CLEAR

Press to clear entry errors.

K DISPLAY

Press to change display mode.

L FL DIMMER

Press to select one of four brightness levels for the display and indicator lamps.

M REPEAT

Press to engage the repeat playback mode.

N PROGRAM

Press to engage the program mode.

Q SKIP (◀◀ / ▶▶)

Press to skip forward or backward during playback.

P PAUSE

Press to pause playback.

Q RETURN

Press in the setup mode to return to a previous level in the setup menu.

R DAC OUTPUT LEVEL

Use to adjust the output level on the D/A converter D-01. Be sure to point the remote control at the D-01 display when using this function. (This function is not available on the D-03.)

S DVD audio operating buttons

The following buttons are used for controlling DVD-Audio and will become available after a future upgrade.

AUDIO

Press to select audio playback during DVD-Audio playback.

GROUP

Press to skip groups during DVD-Audio playback.

Remote Control Unit

How to insert the batteries

Remove the cover of the remote control unit with a screwdriver. After checking the polarity (⊕/⊖) of two AA batteries, insert the batteries, replace the cover and replace the screws.

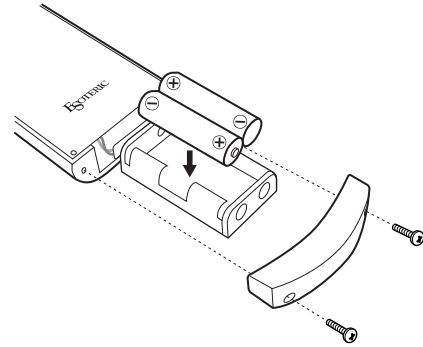

Battery Replacement

If the distance required between the remote control unit and main unit decreases, the batteries are exhausted. In this case replace the batteries with new ones.

Precautions concerning batteries

- Be sure to insert the batteries with correct positive “⊕” and negative “⊖” polarities.
- Use batteries of the same type. Never use different types of batteries together.
- Rechargeable or non-rechargeable batteries can be used but not mixed together. Refer to the precautions on their labels.
- When the remote control unit is not to be used for a long time (more than a month), remove the batteries from the remote control unit to prevent them from leaking. If they leak, wipe away the liquid inside the battery compartment and replace the batteries with new ones.
- Do not heat or disassemble batteries and never dispose of old batteries by throwing them in a fire.

Notes on use

- Point the remote control unit at the main unit's remote sensor within seven meters (23 feet) of the main unit. There should not be any obstacles between the player and the remote control unit.
- Do not allow direct sun or other light to shine on the remote sensor part of the main unit. This may cause the remote control unit to work incorrectly.
- Note that other units with remote controls may operate incorrectly because of infrared light “overspill” when you operate this remote control unit.

Using the P-03 for the first time

When using the P-03 for the first time or after the P-03 has been reset to factory defaults, it is necessary to setup the digital outputs.

When all connections are completed, perform the following operations. Note that no sound may be output unless the setup required by the terminal connections are properly performed.

1 Turn the unit on.

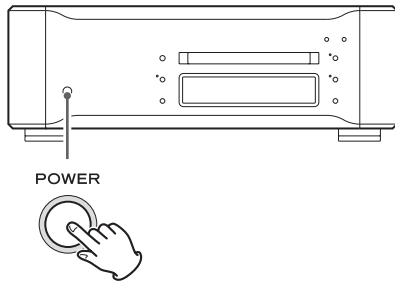

"OUT>Select" blinks on the display.

2 Use the SKIP button (◀◀ / ▶▶) to select digital output.

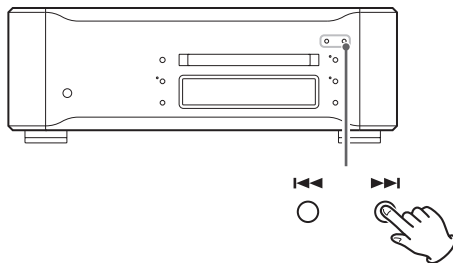

XLR, DUAL, i.LINK, RCA

The output changes with each press of the button. Select the terminal to which the D/A converter is connected.

- Select DUAL when a dual AES device is connected to the unit using XLR digital cables.
- ES-LINK is a proprietary Esoteric format enabling Super Audio CD digital output. In order to output signals in ES-LINK format, connect an Esoteric ES-LINK compliant D/A converter (D-03 or D-01) to the two XLR terminals on the unit using XLR digital cables, select the DUAL digital output, and play a Super Audio CD.

3 Press the PLAY AREA button twice to exit setup.

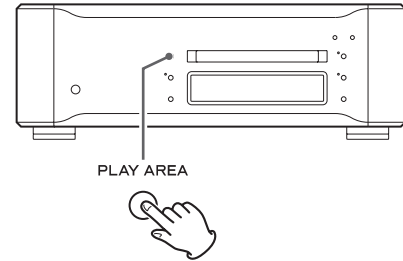

If you want to change the setting, refer to the following page.

Digital output and selecting priority playback area

Select digital output according to connected terminals. Note that incorrect selection will result in no sound output.

Perform the operations described in the section "Using the P-03 for the first time" on the previous page before using the P-03 for the first time or after the P-03 has been reset to factory defaults.

1 Turn the unit on.

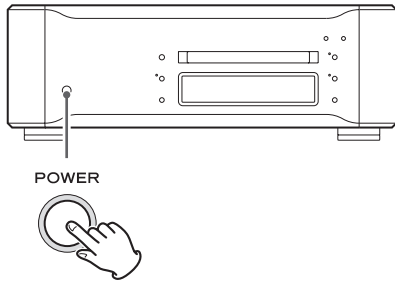

2 Hold down the PLAY AREA button for 2 seconds or more.

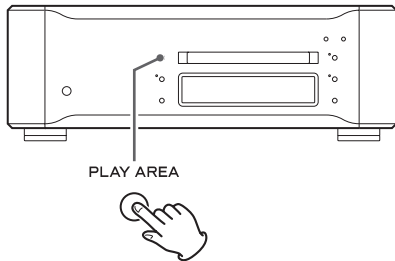

Release the button when "OUT> ***" appears on the display. ("***" depends on the setting.)

The GUI indicator lights when the setup mode is engaged.

3 Use the SKIP button (◀◀ / ▶▶) to select digital output.

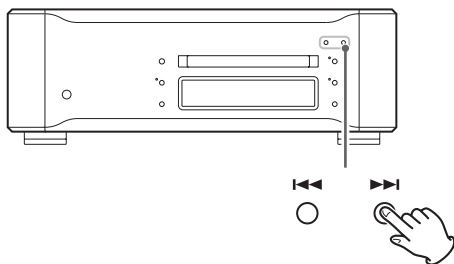

The output changes with each press of the button. Select the terminal to which the D/A converter is connected.

- Select DUAL when a dual AES device is connected to the unit using XLR digital cables.
- ES-LINK is a proprietary Esoteric format enabling Super Audio CD digital output. In order to output signals in ES-LINK format, connect an Esoteric ES-LINK compliant D/A converter (D-03 or D-01) to the two XLR terminals on the unit using XLR digital cables, select the DUAL digital output, and play a Super Audio CD.

To select a digital output, perform operations up to Step 3. Then wait for 10 seconds until the display returns to normal.

To select a Super Audio CD area, go to Step 4.

4 Gently press the PLAY AREA button.



"LAYER>SACD" or "LAYER>CD" appears on the display.

There are two types of Super Audio CDs, regular ones that contain 2-channel stereo and multi-channel stereo and hybrid discs (two-layer discs) that contain Super Audio CD and regular CD data.

The setting described here allows you to determine which layer will be first selected for playback (the priority playback layer) with a hybrid Super Audio CD.

5 Press SKIP (◀◀ / ▶▶) to change setting.

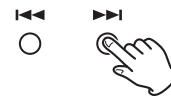

SACD (default setting):

This mode gives priority to the Super Audio CD layer. The "2ch" setting of the "2ch/Multi ch" selection plays back the 2-channel layer while the "Multi ch" setting plays back the multi-channel layer.

CD:

This mode gives priority to the CD layer.

- Selecting a layer that is not on the disc results in playback of the layer found on the disc.
- A change of playback layer using the PLAY AREA button when playback is stopped is overridden by the setting selected using operations described here when a different disc is loaded.

6 Gently press the PLAY AREA button (or leave the unit idle for 10 seconds) to exit setup.



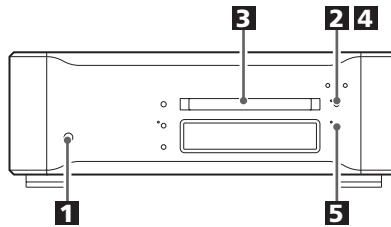

1 Turn the unit on.



Each press of the POWER button turns the unit on and off. The ring around the button and the display lights when the unit is on.

- Also turn on D/A converters, amplifiers and other devices connected to the unit.
- When the WORD button is set to on, "WRD UNLOCK!" or "NO WORD" will appear on the display when the unit is turned on as a word signal cannot be detected as soon as the unit is powered up. These messages vanish when the word signal is locked.

2 Press the OPEN/CLOSE button.



The shutter opens and the disk tray slides out.

- The tray opens after a few seconds (this delay is normal and due to the movement of internal mechanisms in the unit before opening).

3 Place the disc in the disc tray with the label side up.

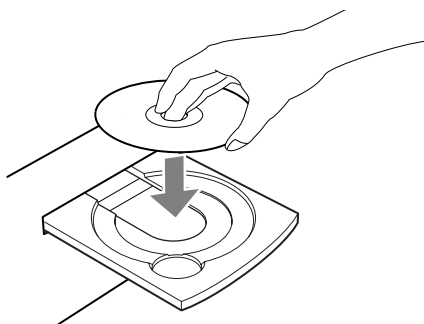

Make sure the disc is placed in the center tray recess to avoid malfunction or jamming of the tray.

4 Press the OPEN/CLOSE button.



The disc tray and shutter opens. Take care to avoid pinching your fingers in the moving tray.

- The OPEN/CLOSE button indicator flashes when the tray opens or closes and when a disc is being read.
- The unit reads the disk, which takes some time. "LOADING" appears on the display during reading. After reading, the total number of tracks on the disc and total playback time appears.

5 Press the PLAY/PAUSE button.

Playback starts.



Pausing playback

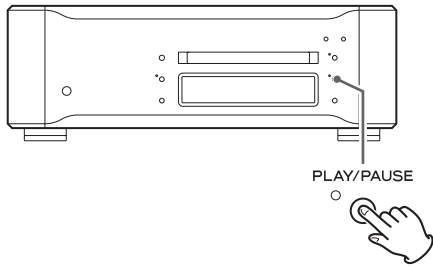

Press the PLAY/PAUSE button to momentarily pause playback. The indicator lights when playback is paused. Press the PLAY/PAUSE button again to resume playback.

Stopping playback

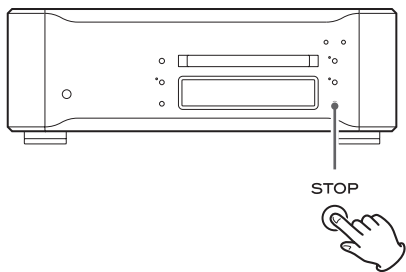

Press the STOP button.

Opening and closing the disc tray

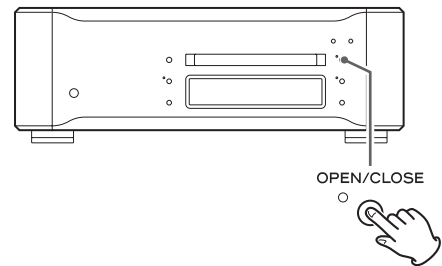

Press the OPEN/CLOSE button once to open (or close) the tray and press it a second time to close (or open) the tray.

- It takes longer time for the tray to open when the OPEN/CLOSE button is pressed during playback.

Selecting playback area

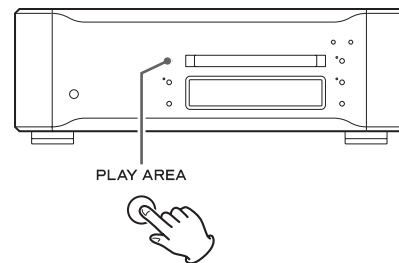

There are two types of Super Audio CDs, regular ones that contain 2-channel stereo and multi-channel stereo and hybrid discs (two-layer discs) that contain Super Audio CD and regular CD data.

Use the PLAY AREA button to select a playback area on a hybrid Super Audio CD when such a disc is loaded but not in playback mode.

- The setting described on page 17 allows you to determine which layer will be first selected for playback (the priority playback layer).

Selecting a track using the number buttons

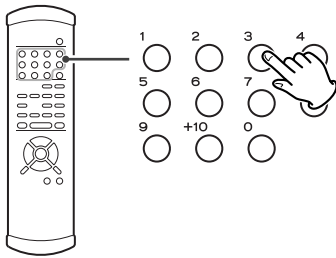

Use the number button to select tracks for playback. Use the +10 button to enter the first digit of numbers greater than 9 (repeated presses will show 1-, 2-, 3- etc.) and the single digit buttons (0 through 9) for the second digit, or single-digit track numbers.

Playback starts from the selected track, regardless of whether the number is selected during playback or when playback is stopped or paused.

Skipping playback

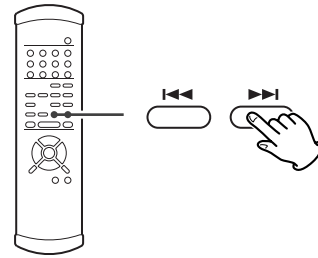

Press the SKIP button on the front panel or the remote control (I◀◀/▶▶I) during playback to skip to the next or previous track.

- Press the I◀◀ button once to return to the beginning of the current track. Further presses of the I◀◀ button will take you further back. Note that pressing the I◀◀ button when 1 second or less of the current track has been played will move playback to the previous track.
- Pressing the I◀◀/▶▶I button when playback is paused or stopped, pauses or stops playback at the beginning of the selected track.

Forward and backward scanning

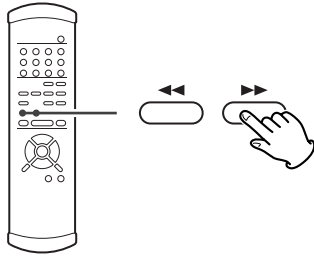

Press the SCAN button (◀▶) during playback to scan forward and backward. Press the PLAY button (▶) to play a track you wish to listen to.

Repeated presses of the SCAN buttons (◀▶) sequentially changes the scanning speed. There are three speeds:

▶ : Fast forward (1) → Fast forward (2)
→ Fast forward (3) → normal playback speed

◀ : Fast backward (1) → Fast backward (2)
→ Fast backward (3) → normal playback speed

- Holding down the SKIP button (◀▶) of the main unit 1 second or longer during playback changes the fast forward/backward speed.

2ch/Multi ch

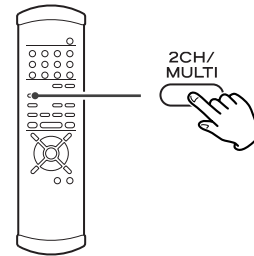

Press to select 2ch (2-channel stereo) or MULTI (multi-channel surround) audio output.

2ch

This mode outputs 2-channel stereo sound. During playback of multi-channel data on a Super Audio CD, the multi-channel data is downmixed to stereo (front left and right channels). (The DOWN MIX indicator on the display lights.) Select this mode to listen to 2-channel stereo.

Multi ch

This mode outputs discrete 5.1-channel audio. Select this mode when the P-03 is used with three D-03 units or with a multi-channel D/A converter and an i.LINK connection.

- The 5.1-channel indicator lights when "Multi ch" is selected.

Programmed playback

Programmed playback allows up to 30 tracks to be played back in the order you decide.

1 Press the PROGRAM button either during playback or when playback is stopped.

The currently played track is added as the first item in the programmed playback list.

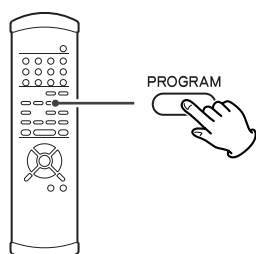

2 Use the number buttons to add tracks to the programmed playback list.

Use the +10 button and 0 through 9 buttons in exactly the same way as when selecting tracks.

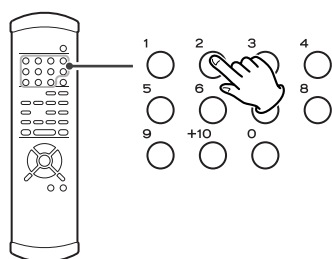

Programmed track number



The total time of programmed tracks is displayed, then the program number (1 to 30) appears.

Continue pressing the number buttons to add tracks.

- Clear mistakes with the CLEAR button (the last entry is cleared)
- You can only select tracks on the disc (in other words, if the disc has six tracks, you cannot program track 7).

3 Press the PLAY (▶) button when a program entry is completed.

Programmed playback starts.

- The PLAY button need not be pressed when programs are made during playback.

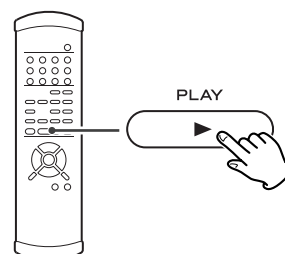

Editing programs

Press the CLEAR button to delete the last added track number.

Adding programs

Use the number buttons to add track numbers during playback or when playback is stopped.

Returning to normal playback

Press the PROGRAM button to exit the program mode. Note that pressing the PROGRAM button during programmed playback cancels the programmed playback and normal playback is resumed.

- The content of the program is canceled. Pressing the OPEN/CLOSE button will also clear program data.

Repeat mode

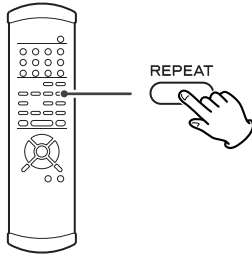

Use the REPEAT button to select the repeat mode for playback. Repeated presses of the REPEAT button cycle between the following options.

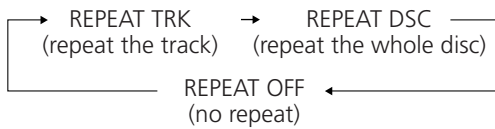

- Halting playback stops the repeat mode.
- The following buttons cancel repeat mode:
STOP, OPEN/CLOSE, POWER.

REPEAT TRK (Track repeat)

Repeats the currently selected track. When another track is selected during repeat playback, this track repeats.

REPEAT DSC (Disc repeat)

Repeats all the tracks on the disc.

Press the REPEAT button once to repeat playback of the programmed tracks.

Programmed repeat

If programmed playback has been set up, the whole program is repeated.

Pushing the REPEAT button cycles between REPEAT PGM (program repeat) and REPEAT OFF (programmed playback takes place).

Changing display mode

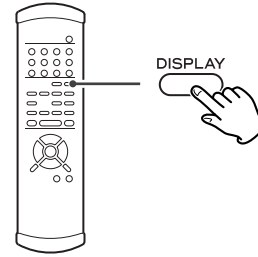

Use the DISPLAY button during playback or when playback is stopped to select the display modes described below.

- The display shows "total number of disc tracks" and "total playback time" when playback is stopped.
- The DISPLAY button does not work during programmed playback.

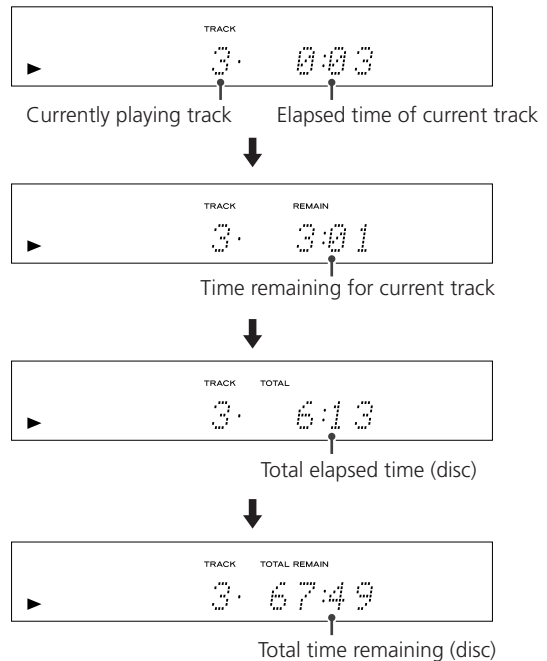

Display dimming

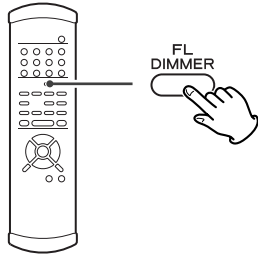

Use the FL DIMMER button to select any of the following brightness levels for the display and button indicators.

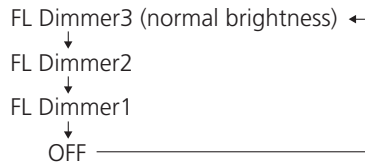

- Pressing a button when the display mode is set to OFF lights the display for about 3 seconds.
- Note that turning off the unit cancels the OFF setting. The display uses the Dimmer 1 setting when the unit is turned on next time.

Word sync

Use this feature to lock your entire system to a single sync signal (clock) by connecting this unit to the Esoteric D-03, G-0, G-0s or similar device that outputs a sync signal or when you want to use a precision external clock rather than the one inside the P-03.

Each press of the WORD button turns the function on or off.

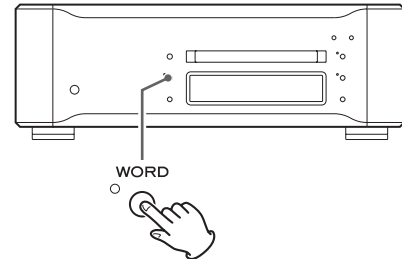

Word ON ↔ Word OFF (normal playback)

- This unit is ready for the following clocks and switches itself depending on an incoming signal:
44.1 kHz, 88.2 kHz, 176.4 kHz, 192 kHz
It also accepts a Universal Clock frequency of 100 kHz.
- The indicator flashes and the unit starts searching for an external sync signal when "Word ON" is selected. The indicator changes to a steady blue light when the unit detects and locks to an external clock to indicate it is ready for playback.
- Make a connection to the WORD SYNC terminal before power up the unit.
- Switching word sync on and off may occasionally result in noise from the D/A converter. If this is the case, turn off the unit and lower the amplifier sound volume before switching the function on or off.

Up convert

You can convert the 44.1 kHz CD sampling frequency to 1x, 2x or 4x. It is also possible to convert the CD PCM signal to a DSD signal.

Press the UP CONVERT button once to display current settings. Further presses change the up conversion rate.

The normal screen display returns 3 seconds after the last button press.

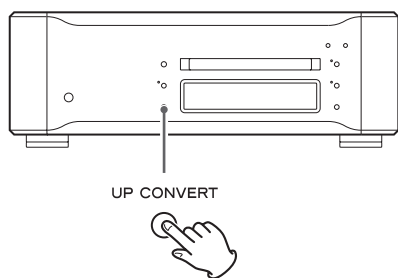

CONV 44.1

A 1x conversion rate that outputs the 44.1kHz CD sampling frequency.

CONV 88.2

A 2x conversion rate that outputs a sampling frequency twice the 44.1kHz CD sampling frequency.

CONV 176.4

A 4x conversion rate that outputs a sampling frequency four times the 44.1kHz CD sampling frequency.

The DUAL digital output mode combined with the 176.4kHz sampling frequency outputs an 88.2kHz left channel from the XLR1(L) terminal and an 88.2kHz right channel from the XLR2(R) terminal.

This requires two XLR cables and a DUAL AES compliant D/A converter.

CONV DSD

When an ES-LINK compliant device is connected to the XLR terminals, the P-03 can convert CD PCM signals to the DSD signals (1 bit, 64 fs) that are used on a Super Audio CD through the XLR terminals. (This signal is output only via the XLR terminals.)

CONV OFF

This setting provides no up conversion.

- Super Audio CDs output a DSD signal (1 bit, 64fs) and cannot be up converted.
- Select 88.2kHz or 176.4kHz for the DUAL digital output mode. A 44.1kHz or OFF setting will result in no data being output.
- The i.LINK terminal cannot output upconverted signals or signals converted to DSD signals. The RCA terminals cannot output signals converted to DSD signals. For details, see the chart on page 8.

Settings (introduction)

1 Turn the unit on.

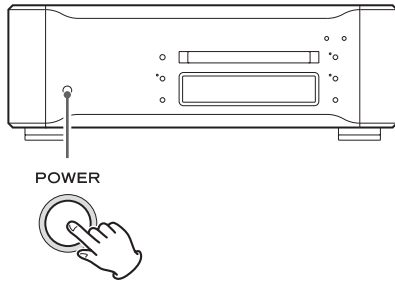

2 Press the SETUP button.

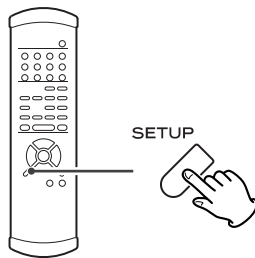

The setup mode is engaged, the GUI indicator lights and "AudioSetup", the first item, appears on the display.

- Although setup menu entries are possible during playback, not all items are available. Stop playback to make all items available.
- Exit the setup menu by pressing the SETUP button once again.

3 Use the cursor buttons to navigate the menus.

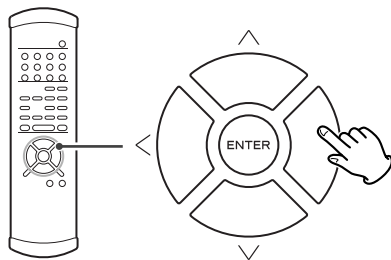

The setup items are on multiple levels. Use the cursor buttons to navigate while referring to the Setup Menu Chart on the following page.

The character ">" is prefixed to options that can be adjusted.

Use the left and up cursor buttons (or the RETURN button) to go back a level in the setup menu.

4 Use the up or down cursor buttons to change an option and press the ENTER button to confirm it.

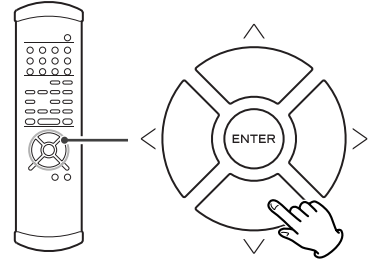

For details on individual settings, see pages 28-29.

Use the up or down cursor buttons to change numeric values. (The ENTER button need not be pressed.)

Use the instructions in Steps 3 and 4 to set multiple functions.

5 When all settings have been made, press the SETUP button to exit the setup menu.

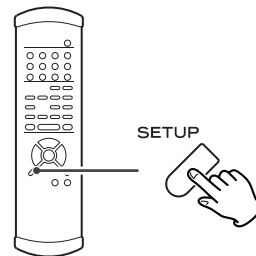

Restoring factory default settings

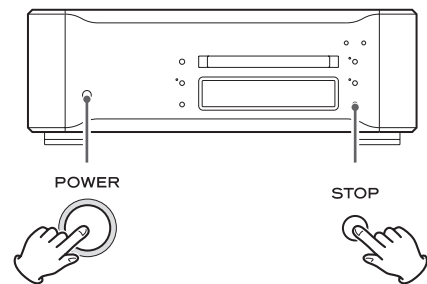

Made settings persist on a semipermanent basis even when the power plug is disconnected.

Use the following procedure to clear all settings and restore the unit to the factory defaults.

1. Turn the unit off and wait 30 seconds or longer.

2. Press the POWER switch while holding down the STOP button.

Hold down the STOP button until the unit is powered up and the display lights.

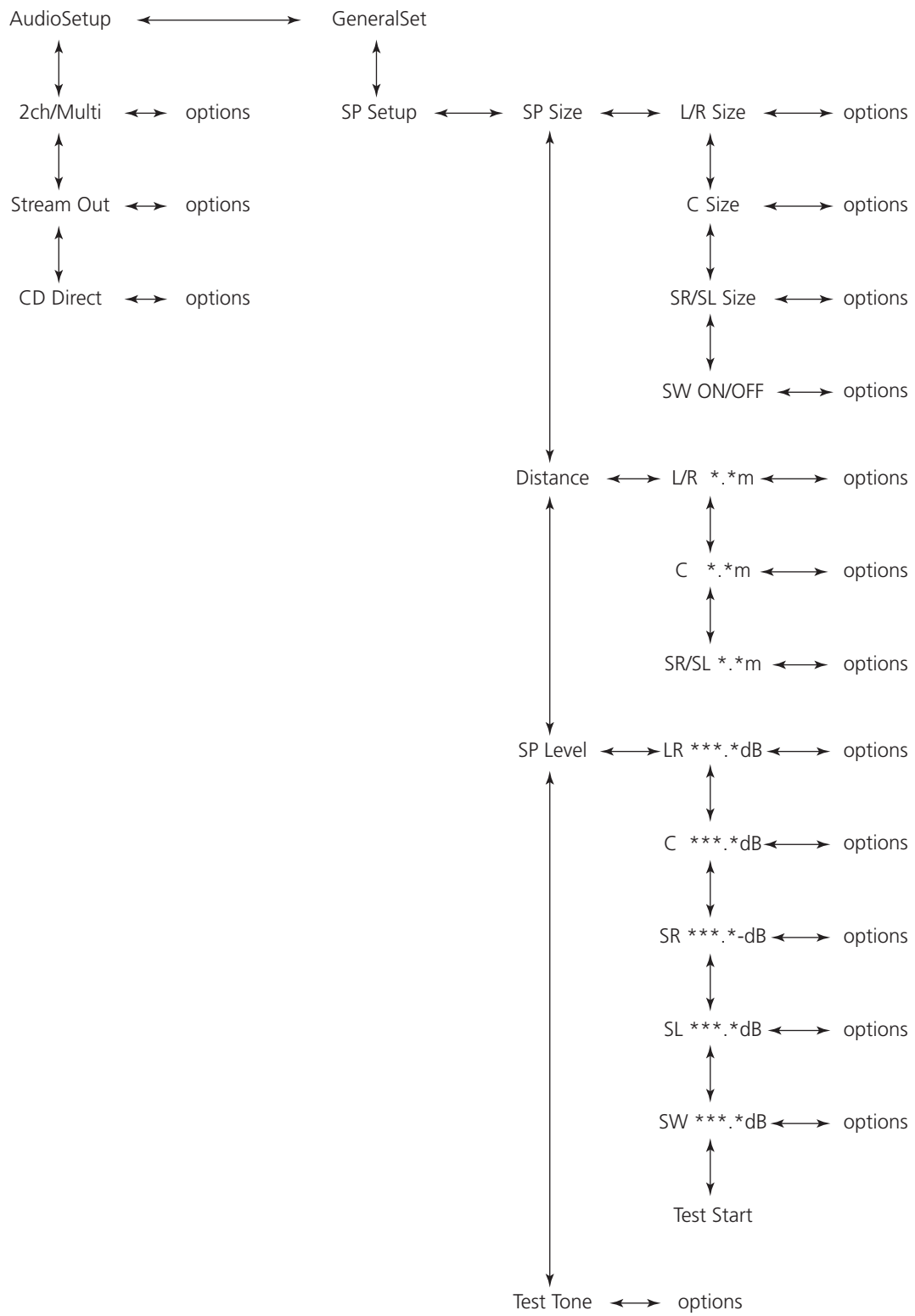

Settings (Audio)

2ch/MULTI setting

Use the up or down cursor buttons to change an option marked ">" and press the ENTER button.

2ch (factory default)

This mode outputs 2-channel audio by downmixing from multi-channel stereo.

Multi ch

This mode outputs discrete 5.1 channel audio. Select this mode when the unit is connected to a multi-channel D/A converter via the i.LINK terminal.

i.LINK output setup (Stream Out)

This mode switches the signal output from the i.LINK (AUDIO) terminal during CD playback.

Use the up or down cursor buttons to change an option marked ">" and press the ENTER button.

ON

Outputs 60958 mode (stream) during CD playback.

OFF

Outputs linear PCM digital signals during CD playback.

- Some devices may not recognize the signal output in OFF mode. Select ON for such devices.
- Super Audio CD playback outputs DSD signals regardless of output selection.

CD Direct

Use the up or down cursor buttons to change an option marked ">" and press the ENTER button.

Direct (factory default)

This mode bypasses speaker settings and intermediate circuitry.

Use this setting for 2-channel stereo playback.

Normal

Use this mode for multi-channel stereo playback using the speaker settings made with this unit.

Settings (Speaker)

Speaker size (SP Size)

Separate settings are available for front speakers (L/R), center speaker (C), surround speakers (SR/L) and the subwoofer (SW).

Use the up or down cursor buttons to change an option marked ">" and press the ENTER button.

Large (factory default)

Select "Large" when using speakers that can faithfully reproduce also the low frequency range.

Small

Select "Small" for small speakers and the low-frequency range will be output to the subwoofer.

OFF

Select OFF for a channel that is not provided with a speaker. The audio for channels set to OFF is distributed among the other channels.

- L/R cannot be turned OFF.

ON (factory default)

Select this mode when a subwoofer is connected.

- Both front speaker "Small" and subwoofer cannot be turned OFF.

Speaker level adjustment (SP Level)

Use this setting to set the relative sound level of the speakers.

Use the up and down cursor buttons to change the numeric values for each item. Each speaker can be adjusted in 0.5 dB increments in the -12 to 6 dB range.

L/R: front speaker

C: center speaker

SR: right surround speaker

SL: left surround speaker

SW: subwoofer

The Distance, Test Start and Test Tone settings will be required after a future update of the P-03 to allow playback of the DVD Audio format.

These settings have no effect on CD and Super Audio CD playback and are not necessary unless the unit is updated.

Speaker distance (Distance)

Ideally, the speakers should be placed so that they are all the same distance from the listening position. If this is not possible, you should use the method described here to adjust them individually.

Use the up and down cursors to adjust the numeric values for each item.

Front speaker (L/R)

Set this distance in 0.1 m increments in the range 0.3 to 9 m. The factory default is 3 m.

Center speaker (C)

Center speaker distance setting depends on the front speaker setting. The maximum distance cannot be greater than the distance set for the front speakers and must not be more than 1.7 m shorter than this distance. Set the distance in 0.1 m increments.

The factory default is the same distance as the front speakers.

Surround speaker (SR/SL)

Like the center speakers, the surround speaker distance setting depends on front speaker setting. The maximum distance cannot be greater than the distance set for the front speakers and must not be more than 9 m shorter than this distance. The minimum distance setting is thus 0 m. Set the distance in 0.1 m increments.

The factory default is the same distance as the front speakers.

- A change in the L/R value automatically changes the C and SR/SL settings. Change the L/R setting before changing the C, and SR/SL settings.
- When the value set for the front speakers (L/R) is outside the range, adjust the differences between C and L/R and between SR/SL and L/R to compensate.

Test tone start (Test Start)

Use the test tone feature to adjust the relative speaker level while listening to the tone.

1. Select "Test Start" and press the ENTER button.
2. While listening to the test tone, use the up and down cursor buttons to move between speakers and the right cursor button select a speaker.
3. Use the up and down cursor buttons to change the numeric values.

- The test tone is stopped when a higher level item is selected.
- Use the volume control on the amplifier to adjust the test tone volume.

Test tone length (Test tone)

Select test tone length when level settings are made. Use the cursor buttons to set the desired length and press the ENTER button.

Use the up or down cursor buttons to change an option marked ">" and press the ENTER button.

Select 2 sec, 5 sec or 10 sec.

In case you experience any problem with this unit, please take the time to look through this chart and see if you can solve the problem yourself before you call your dealer.

No power

- ➔ Check the connection to the AC power supply. Check and make sure the AC source is not a switched outlet and that, if it is, the switch is turned on. Make sure there is power to the AC outlet by plugging another item such as a lamp or fan.
- ➔ Press the POWER switch of the main unit to turn it on.

Remote control doesn't work.

- ➔ Press the POWER switch of the main unit to turn it on.
- ➔ If the batteries are dead, change the batteries.
- ➔ Use remote control unit within the range (5m /15ft) and point at the front panel.
- ➔ Clear obstacles between the remote control unit and the main unit.
- ➔ If a strong light is near the unit, turn it off.

Severe hum or noise is heard.

- ➔ Place the unit as far away from a TV as possible.
- ➔ Make sure the line cords and speaker cables are as far away from the AC supply as possible.

Buttons don't work.

- ➔ If another operation is still in process, wait a moment and try again.

Will not play.

- ➔ Reload the disc with the label side UP.
- ➔ This unit cannot play such discs as CD-ROMs. Use a playable disc (see page 7).
- ➔ If the disc is dirty, clean the surface of the disc.
- ➔ A blank disc has been loaded. Load a prerecorded disc.
- ➔ If the unit is condensed, leave the unit for one or two hours with the power turned on (see page 6).

Sound skips.

- ➔ Place the unit on a stable place to avoid vibration and shock.
- ➔ If the disc is dirty, clean the surface of the disc.
- ➔ Don't use scratched, damaged or warped discs.

There is no sound or only a very low-level sound is heard.

- ➔ Check that the amplifier and speakers are connected securely.
- ➔ Check the operation of the amplifier.
- ➔ Check the digital output setting.
- ➔ The sound is muted during pause and fast forward/reverse. Press the PLAY button to resume normal playback.

No digital output from a Super Audio CD

- ➔ Digital audio output from a Super Audio CD requires an Esoteric ES-LINK compliant D/A converter (D-03 or D-01) or a D/A converter with i.LINK (AUDIO) terminals.
- ➔ Output of multi-channel audio requires that the unit is connected to a multi-channel compliant D/A converter via the i.LINK terminal (AUDIO) and that "2ch/Multi" is set to "Multi ch".

The WORD indicator flashes.

- ➔ The word sync mode is selected, but there is no clock source. Turn the word sync mode off.
- ➔ An incompatible signal is input. Check word sync connections and the settings made on connected devices.

The display shows "No Word!"

- ➔ No word clock is being received. Check connections to the external master clock generator, its power supply and output status.
- ➔ The word sync mode is selected, but there is no clock source. Turn the word sync mode off.

The display shows "Word Error".

- ➔ An incompatible signal is input. Check word sync connections and the settings made on connected devices.

The display shows "WRD UNLOCK!".

- ➔ The unit is unable to lock to the input word sync signal. Check the settings of connected devices.

The display shows "TRAY ERR!" when the disc tray is opened or closed.

- ➔ A "TRAY ERR!" appears when the disc tray stops during opening/closing because of an obstacle in front of the tray or because the disc has not been properly loaded. Remove the cause of the error and press the OPEN/CLOSE button again to open or close the tray.

If normal operation cannot be obtained, unplug the power cord from the outlet and plug it again. This resets the internal micro-computer which can be disturbed during electrical storms, power interruptions, et cetera.

For European customers

Disposal of your old appliance



1. When this crossed-out wheeled bin symbol is attached to a product it means the product is covered by the European Directive 2002/96/EC.
2. All electrical and electronic products should be disposed of separately from the municipal waste stream via designated collection facilities appointed by the government or the local authorities.
3. The correct disposal of your old appliance will help prevent potential negative consequences for the environment and human health.
4. For more detailed information about disposal of your old appliance, please contact your city office, waste disposal service or the shop where you purchased the product.

General

System Super Audio CD, CD, CD-R and CD-RW

Power supply

U.S.A./Canada model AC 120 V, 60 Hz

Korea model AC 220 V, 60 Hz

Europe model AC 230 V, 50 Hz

Power consumption 24 W

Weight 30 kg (66 1/8 lbs)

Dimensions (W x H x D) 445 x 158 x 420 mm
(17-1/2" x 6-1/4" x 16-9/16")

Operating temperature +5°C - +35°C

Operating humidity 5% to 85% (no condensation)

Storage temperature -20°C - +55°C

Digital Audio Output

i.LINK (AUDIO) output x 2

XLR output x 2

(Use 2 terminals for ES-LINK or Dual AES output)

RCA coaxial output x 1

Word Clock

Jack BNC x 1

Input level TTL level/75Ω

The main unit can accept and synchronize to the following frequencies received from external devices:

44.1kHz, 88.2kHz, 100kHz, 176.4kHz (rectangular wave)

Input frequency range ±15ppm

Accessories

Power cord x 1

Remote Control Unit (RC-985) x 1

Batteries (AA, R6 or SUM-3) x 2

Screwdriver x 1

Felt pad x 3

Warranty card x 1

Owner's manual x 1

- Design and specifications are subject to change without notice.
- Weight and dimensions are approximate.
- Illustrations may differ slightly from production models.

Block Diagram

