

# EGOTERIC

D-03

D/A Converter  
Owner's Manual



**CAUTION**  
RISK OF ELECTRIC SHOCK  
DO NOT OPEN



CAUTION: TO REDUCE THE RISK OF ELECTRIC SHOCK, DO NOT REMOVE COVER (OR BACK). NO USER-SERVICEABLE PARTS INSIDE. REFER SERVICING TO QUALIFIED SERVICE PERSONNEL.



The lightning flash with arrowhead symbol, within an equilateral triangle, is intended to alert the user to the presence of uninsulated "dangerous voltage" within the product's enclosure that may be of sufficient magnitude to constitute a risk of electric shock to persons.



The exclamation point within an equilateral triangle is intended to alert the user to the presence of important operating and maintenance (servicing) instructions in the literature accompanying the appliance.

## IMPORTANT SAFETY INSTRUCTIONS

- 1) Read these instructions.
  - 2) Keep these instructions.
  - 3) Heed all warnings.
  - 4) Follow all instructions.
  - 5) Do not use this apparatus near water.
  - 6) Clean only with dry cloth.
  - 7) Do not block any ventilation openings. Install in accordance with the manufacturer's instructions.
  - 8) Do not install near any heat sources such as radiators, heat registers, stoves, or other apparatus (including amplifiers) that produce heat.
  - 9) Do not defeat the safety purpose of the polarized or grounding-type plug. A polarized plug has two blades with one wider than the other. A grounding type plug has two blades and a third grounding prong. The wide blade or the third prong are provided for your safety. If the provided plug does not fit into your outlet, consult an electrician for replacement of the obsolete outlet.
  - 10) Protect the power cord from being walked on or pinched particularly at plugs, convenience receptacles, and the point where they exit from the apparatus.
  - 11) Only use attachments/accessories specified by the manufacturer.
  - 12) Use only with the cart, stand, tripod, bracket, or table specified by the manufacturer, or sold with the apparatus. When a cart is used, use caution when moving the cart/apparatus combination to avoid injury from tip-over.
- 
- 13) Unplug this apparatus during lightning storms or when unused for long periods of time.
  - 14) Refer all servicing to qualified service personnel. Servicing is required when the apparatus has been damaged in any way, such as power-supply cord or plug is damaged, liquid has been spilled or objects have fallen into the apparatus, the apparatus has been exposed to rain or moisture, does not operate normally, or has been dropped.
    - < Do not expose this apparatus to drips or splashes.
    - < Do not place any objects filled with liquids, such as vases, on the apparatus.
    - < Do not install this apparatus in a confined space such as a book case or similar unit.
    - < The apparatus draws nominal non-operating power from the AC outlet with its POWER switch in the off position.
    - < The apparatus should be located close enough to the AC outlet so that you can easily grasp the power cord plug at any time.
    - < An apparatus with Class I construction shall be connected to an AC outlet with a protective grounding connection.

WARNING: TO PREVENT FIRE OR SHOCK HAZARD, DO NOT EXPOSE THIS APPLIANCE TO RAIN OR MOISTURE.

### CAUTION

- < DO NOT REMOVE THE EXTERNAL CASES OR CABINETS TO EXPOSE THE ELECTRONICS. NO USER SERVICEABLE PARTS ARE WITHIN!
- < IF YOU ARE EXPERIENCING PROBLEMS WITH THIS PRODUCT, CONTACT TEAC FOR A SERVICE REFERRAL. DO NOT USE THE PRODUCT UNTIL IT HAS BEEN REPAIRED.

### For U.S.A.

This equipment has been tested and found to comply with the limits for a Class B digital device, pursuant to Part 15 of the FCC Rules. These limits are designed to provide reasonable protection against harmful interference in a residential installation. This equipment generates, uses, and can radiate radio frequency energy and, if not installed and used in accordance with the instructions, may cause harmful interference to radio communications. However, there is no guarantee that interference will not occur in a particular installation. If this equipment does cause harmful interference to radio or television reception, which can be determined by turning the equipment off and on, the user is encouraged to try to correct the interference by one or more of the following measures:

- Reorient or relocate the equipment and/or the receiving antenna.
- Increase the separation between the equipment and receiver.
- Connect the equipment into an outlet on a circuit different from that to which the receiver is connected.
- Consult the dealer or an experienced radio/TV technician for help.

### CAUTION

Changes or modifications to this equipments not expressly approved by TEAC CORPORATION for compliance will void the user's warranty.

### CAUTION

Ensure this product is not exposed to dripping or splashing and that no object filled with liquids, such as vases, is placed on the product.

Do not install this equipment in a confined space such as a book case or similar unit. Allow adequate air circulation around this product.

## For European customers

### Disposal of your old appliance



1. When this crossed-out wheeled bin symbol is attached to a product it means the product is covered by the European Directive 2002/96/EC.
2. All electrical and electronic products should be disposed of separately from the municipal waste stream via designated collection facilities appointed by the government or the local authorities.
3. The correct disposal of your old appliance will help prevent potential negative consequences for the environment and human health.
4. For more detailed information about disposal of your old appliance, please contact your city office, waste disposal service or the shop where you purchased the product.

## Contents

**Thank you for choosing Esoteric. Read this manual carefully to get the best performance from this unit.**

Features . . . . .	4
Before Use . . . . .	5
Connections . . . . .	6
Connection examples (connecting three D-03) . . . . .	8
i.LINK (IEEE 1394) . . . . .	9
Front panel features . . . . .	10
Basic Operation . . . . .	11
Display dimming . . . . .	11
Word sync . . . . .	12
Digital filter . . . . .	12
Changing settings . . . . .	13
Major settings . . . . .	14
Messages . . . . .	14
Troubleshooting . . . . .	15
Specifications . . . . .	15
Block Diagram . . . . .	16

## **This independent D/A converter explores new musical frontiers in a manner only possible to Esoteric, the acknowledged leader in Super Audio CD/CD playback.**

The D-03 delivers high-quality reproduction of DSD stream signals, 192 kHz/24-bit high-sampling PCM signals and other data-rich formats without data loss.

It has been specifically developed to reproduce the ambience and resonance that is found on Super Audio CDs.

## **DAC "AD1955" with DSD input**

The DAC device features "AD1955" supporting DSD and PCM signal input in a differential configuration.

It can fully express the presence and smooth frequency response that the Super Audio CD format delivers and can elicit superior performance also from regular CDs.

## **The D-03 inherits the monaural specifications and strengths of the D-01**

D-01 know-how is used throughout.

- Right and left analog power transformers, analog power supplies and analog audio circuits are completely independent while using the exact same components and the same layout pattern.
  - The analog output units employ discrete circuits with high-voltage power.
  - The power transformers comprise a total of three high-efficiency audio R core transformers: one digital and two analog transformers.
- The analog power supply uses discrete power stability circuits.
- A digital filter OFF function is provided.

## **Straight signal transmission**

A straightforward PCB layout of both the digital and analog circuitry prevents loss of tonal clarity.

A RAM-link without data processing capability eliminates jitter. The provided digital filter has an off setting.

The usual analog filter in the  $F_s/2$  region has been dispensed with and there are no switching or adjusting circuits. Filtering elements and transmission circuits in the power supply and elsewhere have been optimized.

## **Versatile interface that handles a variety of input formats**

In addition to S/PDIF, AES, i.LINK and other formats, the D-03 can be connected to CD, Super Audio CD as well as DVD audio devices.

- All input terminals can handle 192 kHz/24-bit input.
- DSD signals from Super Audio CD are input either via ES-LINK, a proprietary Esoteric format, or i.LINK.
- Two XLR terminals handle Dual AES and ES-LINK format inputs in which case left and right channels are independently transferred.
- CH\_SEL selects audio channel when multi-channel signals are input via i.LINK.

## **Word sync for synchronizing with external equipment**

The Word sync feature provides an OUT mode for outputting a word clock and an IN mode for allowing the unit to lock to an external clock.

The large and highly accurate VCXO crystal oscillator has been specially designed for the D-03. This stable and high-precision clock provides the audio clock signal used for D/A

conversion as well as the highly accurate synchronization for the transport unit.

Further, the Word sync input is optimized to input the ultra-precise G-0s master clock generator. The D-03 can thus handle 44.1, 88.2, 176.4, 48, 96, 192 and 100 kHz word clock input and output specifications.

## **RAM-Link upgraded to process DSD data**

RAM-Link (Refined Asynchronous Memory Link) circuit, now RAM-Link III, has been upgraded to also process DSD data.

The Word sync mode automatically engages RAM-Link to eliminate jitter up to the previous stage before inputting the signal to a DAC device.

## **6N pure copper for internal wiring to realize higher quality sound**

- An essential link in high-quality sound reproduction, the main internal wiring in the D-03 uses 6N pure copper cable for greater purity of sound and better resolution.
- **RCA jacks use the very best materials such as pure copper and gold plating. The D-03 has WBT nextgen sockets for 75 ohm digital inputs and WBT-0201 sockets for analog outputs.**
- Our high-end power inlets made with rhodium plated pure copper go through a super cryogenic process.

## **Highly rigid chassis completely eliminates internal and external vibrations preventing sound and quality deterioration**

Thick aluminum is used in the top, side and front panels as well as in the corner sections while a solid 5 mm thick steel plate with quenched steel pinpoint legs (patent pending) support the entire structure. For greater strength, the internal chassis has a compartmentalized design that adds rigidity, suppresses vibration and effectively removes all electrical interference. The top panel features an 8 mm thick aluminum plate to obliterate any concern for the impact of speaker sound pressure that normally affects conventional designs.

The solid aluminum front and side panels with their brushed finish, the top panel with its beautifully crafted logo and the curved corner design that increases rigidity and reduces vibration all contribute to the sense of quality found only in 2-channel D/A converters designed for the ultimate Super Audio CD/CD system.

The output jacks are not mounted on the PCBs but on the rear panel to protect analog PCBs and the jacks from physical stress and complex vibration modes. Securing the analog PCBs to the internal chassis and the output jacks to the rear panel prevents impairment of sound quality from a failure in the mechanism.

## What's in the box

Please confirm that the following accessories are in the box when you open it.

- Power cord x 1
- Felt pads x 3
- Owner's manual x 1
- Warranty card x 1

## Read this before operation

- < As the unit may become warm during operation, always leave sufficient space around the unit for ventilation.
- < The voltage supplied to the unit should match the voltage as printed on the rear panel. If you are in any doubt regarding this matter, consult an electrician.
- < Choose the installation location of your unit carefully. Avoid placing it in direct sunlight or close to a source of heat. Also avoid locations subject to vibrations and excessive dust, heat, cold or moisture.
- < Do not place the unit on the amplifier/receiver.
- < Do not open the cabinet as this might result in damage to the circuitry or electrical shock. If a foreign object should get into the unit, contact your dealer or service company.
- < When removing the power plug from the wall outlet, always pull directly on the plug, never yank the cord.
- < Do not attempt to clean the unit with chemical solvents as this might damage the finish. Use a clean, dry cloth. A soft cloth moistened with a diluted amount of household or window cleaner can be used to remove more stubborn dirt.
- < Keep this manual in a safe place for future reference.

## Maintenance

If the surface of the unit gets dirty, wipe with a soft cloth or use diluted neutral cleaning liquid. Be sure to remove any fluid completely. Do not use thinner, benzene or alcohol as they may damage the surface of the unit.

"Super Audio CD" is a registered trademark.

"DSD" is a registered trademark.

The i.LINK logo is a trademark of Sony Corporation, registered in the U.S. and other countries.

## Placement of the unit

High-quality hardened tool steel is used for the pin-point feet attached to the bottom of the player. Although the outer feet may appear loose, the weight of the unit causes them to become firm and secure. The design effectively damps and reduces vibration.

- < **WARNING:** Be careful to avoid injury when moving the unit. This unit weighs about 27 kg. Seek assistance when moving or placing this product.
- < To protect the supporting furniture surface, you may stick the felt pads supplied with the unit to the bottom of the metal feet.

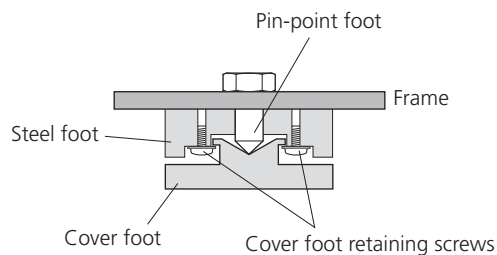

# Connections

**CAUTION:**

- < Switch off the power to all equipment before making connections.
- < Read the instructions of each component you intend to use with this unit.
- < Be sure to insert each plug securely. To prevent hum and noise, avoid bundling the signal interconnection cables together with the AC power cord or speaker cables.

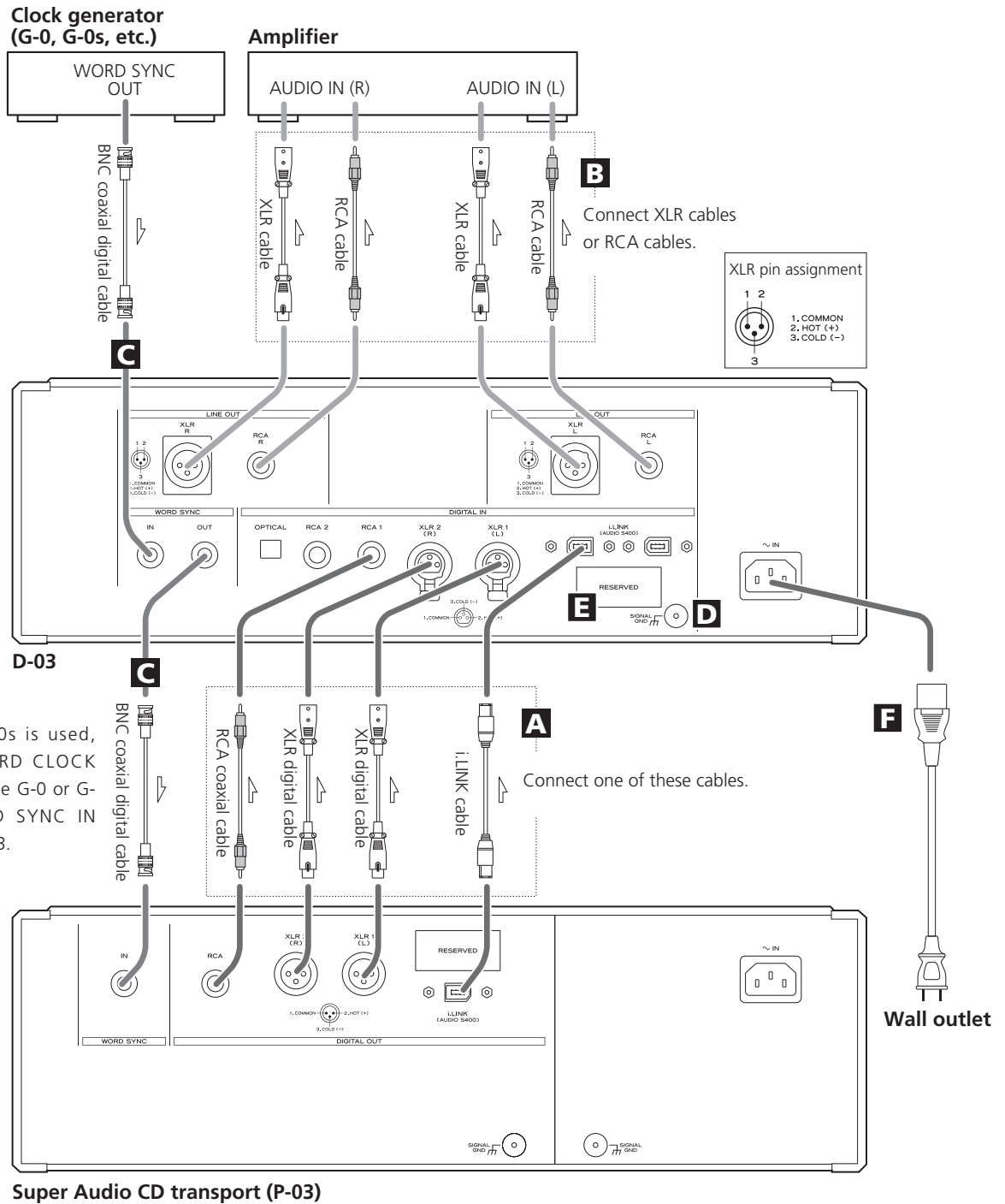

## **A Digital audio input terminals**

These terminals input digital audio. Connect these terminals to the corresponding terminals on a digital device (for example, P-01, P-03, etc.).

### **Use commercially available cables for the following connections.**

XLR: Use a balanced XLR digital audio cable

RCA: Use an RCA coaxial digital cable

OPTICAL: Use an optical digital cable

i.LINK (AUDIO): Use S400 compatible 6-pin i.LINK cable (IEEE 1394 cable)

< The i.LINK (AUDIO) terminal is a combined input and output cable interface.

< XLR is a Dual AES terminal. If your digital device supports Dual AES, use two balanced cables to connect XLR1 (L) on this unit to the L-terminal on the digital device and the XLR2 (R) terminal to the R-terminal on the digital device.

## **B Analog audio output terminals (LINE OUT)**

Outputs analog audio.

Use two commercially available balanced XLR cables to connect the XLR terminals to an amplifier.

If the amplifier is not equipped with XLR audio input terminals, use two commercially available RCA audio cables for making connections.

## **C Word sync input/output terminal (WORD SYNC)**

Outputs/inputs a synchronizing signal.

Connect the WORD SYNC IN terminal to the word clock output terminal on a G-0/G-0s or other word clock generator.

Connect the WORD SYNC OUT terminal to the WORD SYNC IN on a digital device.

Use a commercially available BNC coaxial digital cable (impedance: 75 ohm).

## **D GND terminal**

Connecting the ground terminals on the CD transport unit and the amplifier to ground using a commercially available ground cable may improve the sound quality.

< Note that this is not an electrical safety ground (earth).

## **E Power cord**

Connect the power cord to the power cord receptacle and connect the power plug to a AC wall outlet when all other connections have been made.

< Although the power cord receptacle has a 3-pin plug, the ground pin is not connected to the chassis.

< Use only the supplied Esoteric power cord. Use of other power cords may result in fire or electric shock. Unplug the power cord when you are not going to use the unit for some time.

# Connection examples (connecting three D-03)

## Example 1:

when no clock generator is available

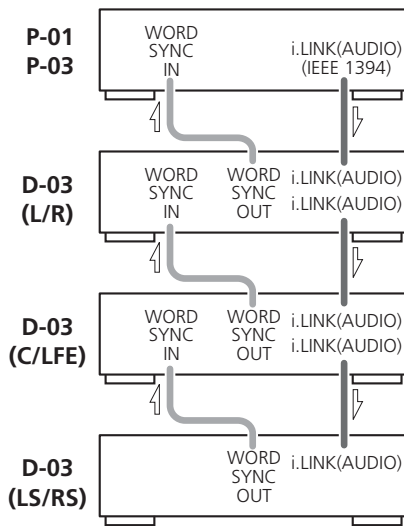

Three D-03 units are required to play multi-channel Super Audio CD or DVD audio without down-mixing.

First, connect the i.LINK (AUDIO) terminal on the Super Audio CD transport unit (P-01/P-03) to the D-03 i.LINK (AUDIO) terminal. Then connect the other i.LINK (AUDIO) terminal on the D-03 to the next D-03 unit. Daisy chain the three units similarly (in random order). Connect the Word sync terminals as shown in example 1 (in random order).

When connecting clock generator G-0/G-0s to the D-03, connect the WORD CLOCK OUT terminals on the G-0/G-0s word clock generator to the WORD SYNC IN on each device (example 2).

## Example 2:

when a clock generator is available

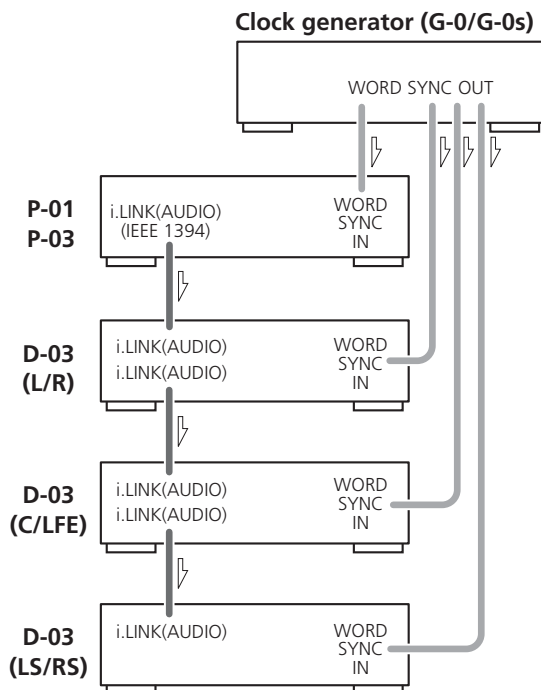

### Setting of the P-01

Output button	IEEE 1394
WORD button	IN (When the G-0s is connected, "Rb IN")
UP CONVERT button	176.4/192

### Setting of the P-03

Digital Output setting	i.LINK
WORD button	ON

### Setting of the D-03

INPUT button	i.LINK
WORD button	One of the D-03 that outputs word synchronization signals: "OUT" The others: "IN" When the G-0 is connected, set all the D-03s to "IN".
W_OUT setting	176.4 or 88.2
CH_SEL setting	respective channels

### Setting of the G-0/G-0s

Frequency change button (A, B or C)	176.4 kHz or 88.2 kHz
FREQUENCY MODE button	44.1kHz



The i.LINK is also known as IEEE 1394, an international specification.

This unit is ready for i.LINK (AUDIO).

By connecting an i.LINK (AUDIO)-capable device to the IEEE 1394 (or i.LINK (AUDIO) terminal on this unit using an i.LINK cable, you can transmit Super Audio CD multi-channel signals that could not be transmitted but in analog format in the past can be transmitted in its original digital format, in addition to the capability of transmitting 2-ch linear PCM data and multi-channel compressed audio signals.

If you have multiple i.LINK-capable devices, you can connect them through other devices to transmit data between them, so you don't need to be concerned with the order of connection.

## Copyright protection system DTCP

To play back audio sounds recorded on Super Audio CD or DVD discs using i.LINK, both the player and the D/A converter need to be ready for the copyright protection system DTCP (Digital Transmission Content Protection).

This unit is ready for DTCP.

## Data transfer rate

There are three transfer rates: 100 Mbps (S100), 200 Mbps (S200), and 400 Mbps (S400). This unit is capable of transferring data at a maximum 400Mbps.

For connection to an i.LINK-capable device, use a commercially available S400-compliant 6-pin i.LINK cable.

When connecting multiple i.LINK-capable devices, avoid connecting a device having slow transfer rate between devices having high transfer rate since this reduces the transfer rate of your whole system. Connect devices having high transfer rate towards the source as far upriver as possible.

## Flow rate control

This unit supports i.LINK flow rate control. Flow rate control means that audio data transferred via i.LINK is first stored in RAM of this unit after which the high-precision clock in the unit is used to fetch the data from RAM to avoid the transfer jitter normally associated with i.LINK transfer. This unit transfers commands to the playback device to change the data transfer rate and control the playback device when data accumulated in RAM exceeds or goes below a certain amount due to differences in clock frequencies in the playback device and this unit. Flow rate control functions in transfers between this unit and another unit.

## NOTES

< Among the i.LINK formats there are "MPEG-2 TS" for BS digital source and "DV" for digital video for DVD recorders, as well as the "i.LINK (AUDIO)" (A&M Protocol). Never connect devices that are not ready for i.LINK (AUDIO) to this unit. If you do, this unit and others may get out of order or be damaged.

< In the process of data transfer, avoid plugging/unplugging the i.LINK cables in use or switch on/off the power.

< Among the i.LINK-capable devices there are some that, if not turned on, are not capable of relaying data.

< Chances are some i.LINK-capable devices will not respond to this unit's command.

## How to connect multiple i.LINK-capable devices

### Daisy chain connection

You can daisy-chain up to 17 devices including this unit.

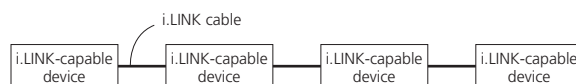

### Connection in tree structure

If you are using a device having three or more i.LINK connectors, you may want to get the connection branched out. This way of connection allows you to connect up to 17 devices including this unit.

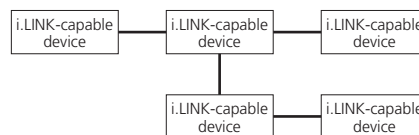

Your system does not work if data is fed back to the output device. Be careful not to create a loop.

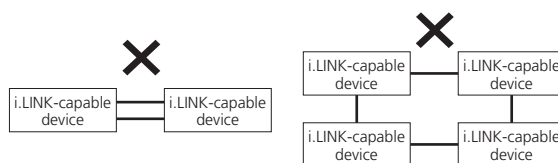

The i.LINK interface of this unit is designed in accordance with the following specifications:

- 1) IEEE Std 1394a-2000, Standard for a High Performance Serial Bus
- 2) Audio and Music Data Transmission Protocol 2.0

This unit is compliant with IEC 60958 bitstream, DVD-Audio, Super Audio CD in the AM824 sequence adaptation layers of this protocol.

## Front panel features

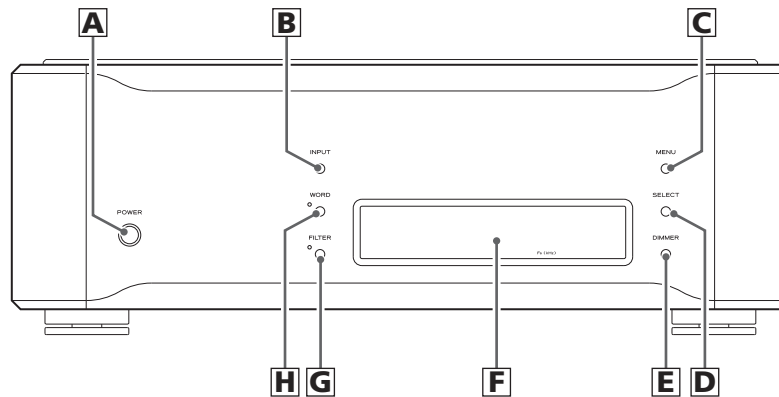

### **A** POWER

Turn power on and off. The ring surrounding the button lights when the unit is on.

The equipment draws nominal non-operating power from the AC outlet with its POWER switch in the OFF position.

### **B** INPUT

Switches digital input source. Select the terminal to which a digital device is connected. The display flashes when a device is not connected or when the connected device is OFF.

### **C** MENU

Press to engage the setup mode.

### **D** SELECT

Press this button after pressing the MENU button to change the setup.

### **E** DIMMER

Press to select one of four brightness levels for the display.

### **F** DISPLAY

Displays current input, sampling frequency, etc.

### **G** FILTER

Turn the digital filter on and off.  
The indicator lamp lights when the filter is on.

### **H** WORD

Press to show current Word sync status. Further presses change modes.

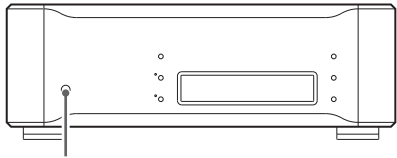

POWER

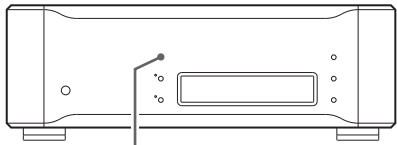
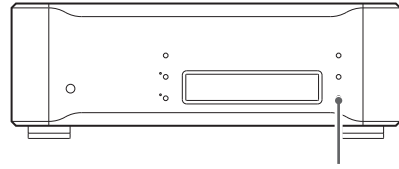

INPUT





# Changing settings

- 1 Press the MENU button until the item you wish to change appears.

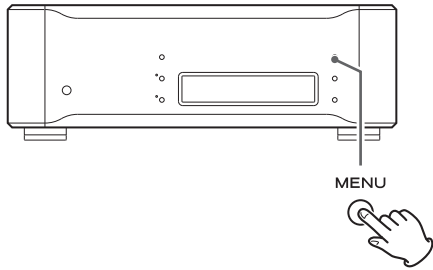

The GUI indicator lights.  
The display indication changes with each press of the MENU button.

< The D-03 exits the setup mode when it is left idle for 10 seconds or more.

## W\_OUT

Select a word frequency (kHz) when the WORD button is set to "W\_OUT". The factory default is 44.1 kHz.

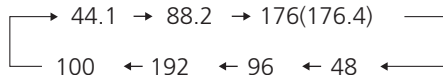

## CH\_SEL

Select channel received when INPUT is set to i.LINK.  
L/R is the factory default.  
L/R: front left and right  
C/LFE: center and subwoofer  
LS/RS: surround left and right

The select channel icons light.



The icons flash when the selected channels do not reflect input signals. In this event, change channels or check digital device connections.

## (Normal display)

This exits the setup mode.

- 2 Use the SELECT button to change settings.

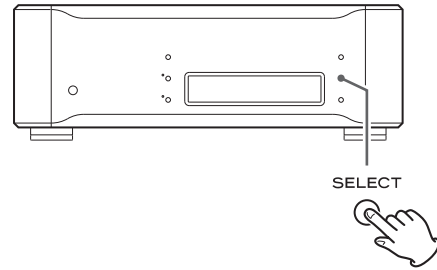

- 3 Press the MENU button (or leave the unit idle for 10 seconds) to end settings.

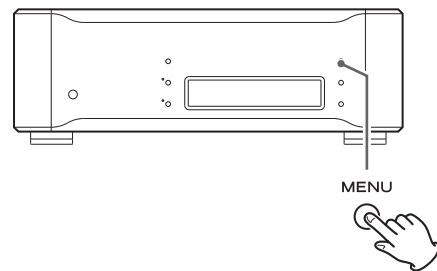

Press the MENU button once or twice to exit the setup mode and return to the normal display.

## Restoring factory default settings

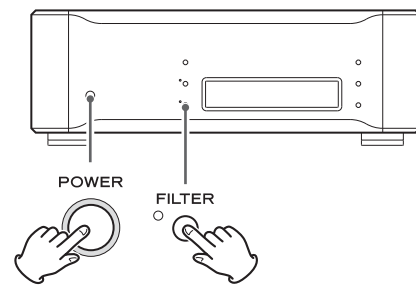

Made settings persist on a semipermanent basis even when the power plug is disconnected.

Use the following procedure to clear all settings and restore the unit to the factory defaults.

1. Turn the unit off.

If the unit is on, turn off the unit and wait 30 seconds.

2. Press the POWER switch while holding down the FILTER button.

Hold down the FILTER button until the unit is powered up and the display lights.

## Major settings

The following examples describe settings when the D-03 is used with the P-01, P-03, G-0 and G-0s.

### Connection using i.LINK cables

#### Setting of the P-01

Output button	IEEE 1394
WORD button	IN (When the G-0s is connected, "Rb IN")
UP CONVERT button	176.4/192

#### Setting of the P-03

Digital Output setting	i.LINK
WORD button	ON

#### Setting of the D-03

INPUT button	i.LINK
WORD button	One of the D-03 that outputs word synchronization signals: "OUT" The others: "IN" When the G-0 is connected, set all the D-03s to "IN".
W_OUT setting	176.4 or 88.2
CH_SEL setting	respective channels

#### Setting of the G-0/G-0s

Frequency change button (A, B or C)	176.4 kHz or 88.2 kHz
FREQUENCY MODE button	44.1kHz

### Connection using XLR digital cables

#### Setting of the P-01

Output button	XLR DUAL
WORD button	IN (When the G-0s is connected, "Rb IN")
UP CONVERT button	176.4/192

#### Setting of the P-03

Digital Output setting	DUAL
WORD button	ON
UP CONVERT button	176.4 or DSD

#### Setting of the D-03

INPUT button	DUAL
WORD button	One of the D-03 that outputs word synchronization signals: "OUT" The others: "IN" When the G-0 is connected, set all the D-03s to "IN".
W_OUT setting	176.4 or 88.2
CH_SEL setting	respective channels

#### Setting of the G-0/G-0s

Frequency change button (A, B or C)	176.4 kHz or 88.2 kHz
FREQUENCY MODE button	44.1kHz

## Messages

### "- -" appears on the right side of the display.

An incompatible signal is input.  
Do not input signals other than PCM or DSD.  
Check digital device connections.

### XLR, XLR2, DUAL, RCA1, RCA2, OPT or i.LINK flashes.

The unit cannot detect a digital signal. Press the INPUT button to select a terminal to which a digital device is connected.  
Turn on the connected device. Confirm the settings of the connected device.

### LOOP ERR!

The i.LINK connection has been connected to form a loop.

### NO WORD!

No WORD clock signal is being input.

### UNKNOWN

The device connected via i.LINK is not known.

### WORD ERROR!

The frequency of the input source does not match word frequency. Select 44.1, 88.2 or 176.4 kHz during Super Audio CD playback.

### WRD LCKING

Indicates that the input WORD clock signal is locked.

### WRD UNLCK!

Indicates that the device cannot lock to the input WORD clock signal. Confirm the frequency setting of the connected clock generator. Connect a clock generator whose frequency range with a precision greater than  $\pm 5$  ppm.

### The L and R channel icons flash.

Indicates that L and R have been reversed in a connection to a Dual AES compatible device. Correct the XLR cable connection.

< Normally, the display shows the current input or the device name of connected devices while the right side shows the sampling frequency of input digital signal during CD playback or "DSD" during Super Audio CD playback.

< "F" appears to the right of the Fs (frequency) indication when the i.LINK flow rate control is operating.

## Troubleshooting

In case you experience any problem with this unit, please take the time to look through this chart and see if you can solve the problem yourself before you call your dealer.

### No power

- e Check the connection to the AC power supply. Check and make sure the AC source is not a switched outlet and that, if it is, the switch is turned on. Make sure there is power to the AC outlet by plugging another item such as a lamp or fan.
- e Press the POWER switch of the main unit to turn it on.

### No sound

- e Check amplifier and digital device connections.

### Input indicator flashes.

- e Turn the device connected to the selected input terminal on.
- e Check whether the connection to the selected input terminal is correct.

### A beeping noise occurs at regular intervals.

- e The D-03 is in Word sync mode, but the connected device is not. Check the connection to the Word sync terminal and the setup of the connected device.  
This phenomenon occurs when the error detected is below the limit of detection for the D-03 word error that would normally produce a WRD ERROR.

### The WORD indicator flashes.

- e The Word sync mode is selected, but there is no clock source. Turn the Word sync mode off.
- e An incompatible signal is input. Check Word sync connections and the setup of the connected devices.

### The display shows "NO WORD!"

- e No word clock is being received. Check connections to the external master clock generator, its power supply and output status.
- e The Word sync mode is selected, but there is no clock source. Turn the Word sync mode off.

### The display shows "WRD ERROR!"

- e An incompatible signal is input. Check Word sync connections and the settings made on connected devices.
- e When a device without a Word sync function is used, use the WORD button on the unit to turn off the Word sync function.

### The display shows "WRD UNLOCK!"

- e Connect a clock generator whose output frequency precision is within  $\pm 5$  ppm.

**If normal operation cannot be obtained, unplug the power cord from the outlet and plug it again. This resets the internal micro-computer which can be disturbed during electrical storms, power interruptions, et cetera.**

## Specifications

### General

Power supply  
Europe model . . . . . AC 230 V, 50 Hz  
U.S.A./Canada model . . . . . AC 120 V, 60 Hz  
Korea model . . . . . AC 220 V, 60 Hz

Power consumption . . . . . 24 W

Weight . . . . . 27 kg (59 1/2 lbs)  
External dimensions (W x H x D) . . . . . 445 x 108 x 420 mm  
(17 1/2" x 4 1/4" x 16 9/16")

### Digital Input Terminals

Input format . . . . DSD, linear PCM (32kHz-192kHz, 16-24bit)

i.LINK (AUDIO) terminal (6pin) x2  
XLR x 2, Input level: more than 5.0Vp-p/110 $\Omega$   
(Use 2 terminals for ES-LINK or Dual AES output)  
RCA x2, Input level: more than 0.5Vp-p/75 $\Omega$   
OPTICAL x1, Input level: -24.0 to -14.5dBm peak

### Audio features

Analog output level . . . . . RCA: 2.2 Vrms/10k $\Omega$  (1 kHz)  
XLR: 4.4 Vrms/10k $\Omega$  (1 kHz)  
Frequency response . . . . . 2 Hz - 70 kHz,  $\pm 3$  dB  
2 Hz - 25 kHz,  $\pm 0.5$  dB  
Signal-to-Noise Ratio (S/N) . . . . . 115 dB (JEITA)  
Total harmonic distortion . . . . . 0.0006% (JEITA)

### Word Clock Frequency (input/output)

Jack . . . . . BNC  
Input or output level . . . . . TTL level/75 $\Omega$   
Word Clock Frequency  
44.1, 88.2, 176.4, 48, 96, 192, 100 (kHz)

Output precision . . . . .  $\pm 0.5$  ppm (in mint condition)  
Input frequency range . . . . .  $\pm 5$  ppm

### Accessories

Power cord x 1  
Felt pads x 4  
Warranty card x 1  
Owner's manual x 1

- Design and specifications are subject to change without notice.
- Weight and dimensions are approximate.
- Illustrations may differ slightly from production models.

# Block Diagram

